

UNITED STATES MARINE CORPS  
MOUNTAIN WARFARE  
TRAINING CENTER  
BRIDGEPORT, CA.

**ASSAULT CLIMBERS HANDBOOK**



**SUMMER 2002**

# **ASSAULT CLIMBERS HANDBOOK 2002**

## **TABLE OF CONTENTS**

<b>CHAPTER</b>	<b>CLASS TITLE</b>
1	MOUNTAIN SAFETY
2	MAC KIT
3	NOMENCLATURE AND CARE OF MOUNTAINEERING EQUIPMENT
4	ROPE MANAGEMENT
5	MOUNTAIN CASULTLY EVACUATIONS
6	NATURAL AND ARTIFICIAL ANCHORS
7	MECHANICAL ADVANTAGE
8	ONE ROPE BRIDGE
9	A-FRAMES
10	VERTICAL HAULING LINES
11	SUSPENSION TRAVERSE
12	ESTABLISHMENT OF RAPPEL POINTS AND RAPPELLING
13	BALANCE CLIMBING
14	TOP ROPING
15	SIT HARNESS
16	PLACING PROTECTION
17	BELAYING FOR PARTY CLIMBING
18	PARTY CLIMBING
19	MILITARY AID CLIMBING
20	ALTERNATIVE BELAYS AND ANCHORS
21	RESCUE TECHNIQUES FOR PARTY CLIMBING
22	STEEP EARTH CLIMBING
23	TREE CLIMBING TECHNIQUES
24	FIXED ROPE INSTALLATION
25	CLIFF RECONNAISSANCE
26	CLIFF ASSAULT
27	BIBLIOGRAPHY OF REFERENCES
APPENX 1	SL-3 MAC KIT

**UNITED STATES MARINE CORPS**  
Mountain Warfare Training Center  
Bridgeport, California 93517-5001

SML  
SMO  
02/11/02

**LESSON PLAN**

**MOUNTAIN SAFETY**

**INTRODUCTION**

(5 Min)

- 1. GAIN ATTENTION.** The key to mountain safety in a mountainous environment is proper prior planning. Adhering to certain basic principles and predetermined actions will allow an individual or unit to efficiently perform their duties with minimum discomfort and maximum safety.
- 2. PURPOSE.** The purpose of this period of instruction is to familiarize the student with the twelve mountain safety considerations and the acronym used to remember them. This lesson relates to all training conducted in a mountainous environment.
- 3. INTRODUCE LEARNING OBJECTIVES**
  - a. TERMINAL LEARNING OBJECTIVE.** In a mountainous environment, execute preventive measures for mountain injuries, in accordance with the references.
  - b. ENABLING LEARNING OBJECTIVE.** Without the aid of references and given the acronym "BE SAFE MARINE", list in writing the principles of mountain safety, in accordance with the references.
- 4. METHOD/MEDIA.** The material in this lesson will be presented by lecture and demonstration. You will practice what you learn during upcoming field training exercises. Those of you who have IRF's please fill them out at the conclusion of this period of instruction.
- 5. EVALUATION.** You will be tested later in the course by written and performance evaluations on this period of instruction.

**TRANSITION:** Having discussed our purposes, let's now look at the planning and preparation of a military operation.

**BODY**

(50 Min)

- 1** (40 Min) **PLANNING AND PREPARATION**. As in any military operation, planning and preparation constitute the keys to success. The following principles will help the leader conduct a safe and efficient operation in any type of mountainous environment. We find this principle in the acronym "BE SAFE MARINE". Remember the key, think about what each letter means and apply this key in any type of environment.

B - Be aware of the group's ability.

E - Evaluate terrain and weather constantly.

S - Stay as a group.

A - Appreciate time requirements

F - Find shelter during storms, if required.

E - Eat plenty and drink lots of liquids.

M - Maintain proper clothing and equipment.

A - Ask locals about conditions.

R - Remember to keep calm and think.

I - Insist on emergency rations and kits.

N - Never forget accident procedures.

E - Energy is saved when warm and dry.

- a.** **Be Aware of the Group's Ability**. It is essential that the leader evaluates the individual abilities of his men and uses this as the basis for his planning. His evaluation should include the following:

**1** **Physical Conditioning**. Physical Fitness is the foundation for all strenuous activities of mountaineering. Leaders must be aware of their unit's state of fitness and take in account for the changes in altitude, climate, and amount of time for acclimatization.

**2** **Mental Attitude**. Units need to be positive, realistic, and honest with themselves. There needs to be a equal balance here. A "can do" attitude may turn into dangerous overconfidence if it isn't tempered with a realistic appraisal of the situation and ourselves.

**3** **Technical Skills**. The ability to conduct a vertical assault, construct rope

installations, maneuver over snow covered terrain, conduct avalanche search and rescue operations, etc. The more a unit applies these skills increases their ability to operate in a mountainous environment effectively.

**4**) Individual skills. At this point, you must choose who is most proficient at the individual skills that will be required for your mission, navigation techniques, security, call for fire, track plans, bivouac site selection, skijoring, etc.

**b.** Evaluate Terrain and Weather Constantly

(1) Terrain. During the planning stages of a mission, the leader must absorb as much information as possible on the surrounding terrain and key terrain features involved in his area of operation. Considerations to any obstacles must be clearly planned for. Will you need such things as ropes, crampons, climbing gear, skins, etc.

**a)** Stress careful movement in particularly dangerous areas, such as loose rock and avalanche prone slopes.

**b)** Always know your position. Knowing where you are on your planned route is important.

(2) Weather. Mountain weather can be severe and variable. Drastic weather changes can occur in the space of a few hours with the onset of violent storms, reduced visibility, and extreme changes. In addition to obtaining current weather data, the leader must plan for the unexpected "worst case". During an operation he must diagnose weather signs continually to be able to foresee possible weather changes.

**a)** Constantly evaluate the conditions. Under certain conditions it may be advisable to reevaluate your capabilities. Pushing ahead with a closed mind could spell disaster for the mission and the unit.

**b)** When in a lightning storm, turn off all radios, stage radios and weapons away from personnel. Have personnel separate in a preferably low-lying area, or around tall natural objects, however personnel should not come into direct contact with trees.

**c)** To calculate the approximate distance in miles from a flash of lightning, count in seconds the time from when you see the flash to when you hear the thunder, and divide by five.

**c.** Stay as a Group. Individuals acting on their own are at a great disadvantage in this environment.

**(1)** Give adequate rest halts based upon the terrain and elevation, physical condition of the unit, amount of combat load and mission requirements.

② Remember to use the buddy system in your group.

③ Maintain a steady pace that will allow accomplishment of the mission as all members of the unit reach the objective area.

d. Appreciate Time Requirements. Efficient use of available time is vital. The leader must make an accurate estimate of the time required for his operation based on terrain, weather, unit size, abilities, and the enemy situation. This estimate should also take into account the possibility of unexpected emergencies such as injuries or unplanned bivouacs due to severe conditions.

① Time-Distance Formula (TDF). This formula is designed to be a guideline and should not be considered as the exact amount of time required for your movement. Furthermore, this formula is for use in ideal conditions:

3 kph + 1 hour for every 300 meters ascent; and/or + 1 hour for every 800 meters descent.

**NOTE:** The TDF is made for troops on foot in the summertime or troops on snowshoes in the wintertime.

(2) Route Planning. Route cards are not to be used in place of an overlay, but as a tool to



Being lost will not directly kill an individual. Starvation takes time, but hypothermia can manifest itself in a matter of hours resulting in death.

- 1 ) If there is a drastic change in the weather, tents should be erected immediately.
- 2 ) If tents are not available, the unit leader should begin locating natural shelter or began building a man-made shelter. Adhering to the following principles will give an individual the best chance to spend a relatively safe bivouac with the prospect of continued effort toward mission accomplishment.

a) Make shelter. The requirements for expedient shelters and the building procedures will be covered in another chapter. The basic requirement for protection from the elements is essential.

b) Keep warm. The retention of body heat is of vital importance; any action in which body heat is lost should be avoided. The following points should be considered:

1. Adequate shelter
2. Insulation from the ground using branches, a rucksack, etc.
3. Wear extra clothing.
4. Use extra equipment for insulation.
5. Produce external heat while trying to conserve fuel for future use.

c) Keep dry. Being wet causes the loss of body heat 32 times faster than when dry. Adequate protection from the elements is of prime importance to prevent the onset of hypothermia.

**f.** Eat Properly and Drink Plenty of Fluids

1 ) **Food.** The human body can be compared to a furnace, which runs on food to produce energy (warmth). By planning the consumption of food to suit the specific situation, adequate nutrition and extra warmth can be supplied.

2 ) **Water.** The intake of adequate amounts of water will maintain the body in proper working order. Danger from dehydration is as high in mountain regions as in hot dry areas. Loss of liquids is easily seen and felt in hot climates; whereas in the mountains, the loss of body fluids is much less noticeable. High water intake, at least 4 to 6 quarts per day when in bivouac, 6 to 8 quarts per day when active, will help to prevent dehydration.

**g.** Maintain Proper Clothing and Equipment



**1**) Equipment. In the mountains a man should never be separated from his gear. Here are some basic and essential items that should be considered during your planning stage.

**a**) Assault load

**1.** There should be at least one assault load per squad.

**b**) Combat load

**c**) Existence load.

**d**) Map and compass. Every individual in a leadership position and his assistant should carry a map and compass. The maps should be weatherproofed and extra maps should be distributed throughout the unit.

**e**) Repair kit. This kit should include those items necessary to do emergency repairs on your equipment.

**f**) Survival Kit. Always carried on your person. The contents of a survival kit will be covered in another chapter.

**h.** Ask Locals About Conditions. An often-overlooked source of information is the indigenous population of an area. Local weather patterns, rock slide/avalanche areas, watering points, and normal routes can all be obtained by careful questioning. The unit leader must obtain current information of the actual conditions along his intended route.

**i.** Remember to Keep Calm and Think

**1**) Having recognized that an emergency situation exists, the following principles should be followed:

**a**) Keep calm and do not panic. At this point you must make every effort to conserve body heat and energy.

**b**) Think. When an individual is cold, tired, hungry, or frightened he must force himself to organize his thoughts into a logical sequence.

**c**) The group must try to help itself by either finding the way back to safety or by preparing shelters and procuring food.

**d**) Above all else, the group must act as a tight-knit unit. In emergency situations, individual dissension can cause a total loss of control and unit strength.

**2**) If the decision is reached that the group should seek its way back to safety, several possibilities exist. In most situations, the safest approach will be to retrace the route to the last known point and continue from there. The other course of action is to get a group consensus on the present location and send out a small search party to locate a

known point. This party must ensure that they mark their trail adequately to return to the group. If all attempts at finding a way back to known terrain fail, a definite emergency situation exists and actions discussed later in this section must be instituted.

**j.** Insist on Emergency Rations and Kits. Emergency rations and a survival kit should always be carried.

**k.** Never Forget Accident/Emergency Procedures

**1**) Causes of accidents. The general procedures used to handle accidents differ little in this environment, but several distinct points should be kept in mind. The most frequent causes of accidents are as follows:

**a)** Overestimation of physical and technical abilities.

**b**) Carelessness.

**c)** General lack of observation of one's surroundings.

**d**) Lack of knowledge and experience by leaders.

**e)** The failure to act as a group.

**f**) Underestimation of time requirements to move through mountainous terrain and underestimation of the terrain itself.

**2**) Preventive measures. The only truly effective preventive measures for the above lie in the education and experience of leaders at all levels. Too often, leaders sit by watching during training and as a result have no concept of the requirements involved in the mountainous environment. Only by active involvement can a leader gain the knowledge and experience needed to effectively lead in this environment.

**3**) General procedures for handling an accident. These require only a good dose of common sense as outlined below.

**a)** Perform basic first aid.

**b**) Protect the patient from the elements to include insulation on top and bottom.

**c)** Evacuate if necessary.

**d**) Send for help, if required.

**e)** If possible, never send a man for help alone.

**f**) Send the following information regarding the accident:

1. Time of accident.
2. Nature and location of accident.
3. Number injured.
4. Best approach route to accident scene.

4 ) If one man of a two-man team is injured, the injured man must be given all available aid prior to going for help. If the injured man is unconscious, he should be placed in all available clothing and sleeping gear and anchored if on steep terrain. A note explaining the circumstances, and reassuring him, should be left in a conspicuous spot. This note must also contain the following information:

- a) When you expect to return.
- b ) Where you went.
- c) What you did before you left (medication, etc.).

5 ) International distress signal.

- a) Six short blasts in 1 minute from person requesting help.
- b ) The return signal is three blasts in 1 minute from the respondent.

6 ) Other methods of signaling:

- a) Red pyrotechnics.
- b ) SOS, (...---...)
- c) "Mayday" by voice communications.

l. Energy is Saved When Warm and Dry. With the previous 11 principles in mind this one should fall right into place. Save your heat and energy by following these steps:

- 1 ) Dress properly.
- 2 ) Eat properly.
- 3 ) Drink properly.
- 4 ) Ensure shelter meets criteria.
- 5 ) Produce external heat (fires, stove, extra clothing, etc.) to save body heat and energy for future use.

**6**) Avoid getting wet, this increases body heat loss.

TRANSITION: By applying these 12 principles, you increase your chance for survival.

**PRACTICE**

(CONC)

- a.** Students will apply mountain safety principles throughout the duration of the course.

**PROVIDE HELP**

(CONC)

- a.** The instructors will assist the students when necessary.

**OPPORTUNITY FOR QUESTIONS**

(3 Min)

**1.** QUESTIONS FROM THE CLASS

**2.** QUESTIONS TO THE CLASS

Q. What is the "B" in Be Safe Marine?

A. Be aware of the group's ability.

Q. What is the "F" in Be Safe Marine?

A. Find shelter before storms, if required.

**SUMMARY**

(2 Min)

- a.** Safety in the mountains doesn't come naturally, it must be practiced or the results can be devastating. Constant observation and common sense are the keys to success and safety.

- b.** Those of you with IRF's please fill them out at this time; we will take a short break before the next class.

**UNITED STATES MARINE CORPS**  
Mountain Warfare Training Center  
Bridgeport, California 93517-5001

SML  
SMO  
ACC  
03/31/01

**LESSON PLAN**

**MARINE ASSAULT CLIMBER'S KIT**

**INTRODUCTION**

(5 Min.)

1. **GAIN ATTENTION.** As in any military operation requiring special skills, such as mountaineering, some special equipment requirements particular to the mission must be covered. The Marine Corps has adopted a Marine Assault Climbers Kit (MACK) for this very reason.
2. **OVERVIEW.** The purpose of this period of instruction is to familiarize the students with the MACK, it's components, how to inspect for serviceability, preparing the MACK for use, and maintenance procedures.
3. **METHOD/MEDIA.** The material in this lesson will be presented by lecture and demonstration.
4. **EVALUATION.** This period of instruction has no learning objectives and students will be evaluated throughout their stay at MWTC.

**TRANSITION:** Are there any questions over the purpose, learning objectives, how the class will be taught, or how you will be evaluated? Mountain operations will present tremendous obstacles for your Marines to overcome, by preparing them with the proper gear and equipment; you will reduce the risk involved and increase your chances of success.

**BODY**

**6**  
(60 Min.)

1. (5 Min) **DESCRIPTION.** The Marine Assault Climber's Kit (MACK) is a comprehensive collection of climbing equipment that enables a Marine rifle company (reinforced), approximately 200 men with organic equipment, to negotiate an average 300-foot vertical danger area. The kit contains sufficient climbing equipment to outfit four 2-man climbing teams plus the additional items necessary to supply the remainder of the Rifle Company. The climbing teams use their equipment to conduct 2-party climbs over vertical obstacles and establish various rope installations to facilitate the movement of the remainder of the company. Marines that engaged in training and combat operations in mountainous areas having rugged compartment terrain and steep slopes would use the MACK. Certain items contained in the MACK will also be used during training and combat operations in urban environments for scaling vertical obstacles such as buildings.

**TRANSITION:** Now that we have discussed what the MACK is, are there any questions? Let's discuss the components of the MACK.

2. (5 Min) **SL-3 COMPONENTS.** Four containers hold all the items contained in the MACK, and have features that facilitate the organization and accountability of MACK items. Each container protects the contents from degradation due to sunlight and moisture during storage periods of up to 5 years. The lid's interior has a permanently affixed list of the components and quantities stored within that container. Container #1 contains the climbing team equipment. Containers #2, #3 and #4 contain the company climbing equipment. A manual for care/maintenance of SL-3 components is included with each MACK. Refer to the SL-3 components list for current quantities and items (see attached appendix).

**INSTRUCTOR NOTE:** Have students turn to MACK SL-3 components in appendix 1 and go through the list.

**TRANSITION:** Now that we have covered what a MACK contains, are there any questions? Let's discuss how to keep the MACK ready to go.

3. (5 Min) **SERVICEABILITY.** Any item that becomes unserviceable or shows excessive signs of wear must be replaced immediately. With the exception of the rope bag and climbing rack bag, no attempt should be made to repair the components of the MACK. Any damaged or broken components should be disposed of using standard supply procedures. Replenishment procurement to the Source of Supply should be accomplished using standard MILSTRIP process. Kit components not available through the MILSTRIP process may be procured through local purchase. Minimum strengths and description are covered in the SL-3 list, any brand that meets the function, strength and description can be purchased.

**TRANSITION:** Now that we have discussed serviceability, let us now talk about safety.

4. (5 Min) **SAFETY.** A Marine NCO, SNCO or Officer who has received formal military mountaineering training must supervise any Marine using components of the MACK. This formal instruction must be provided by the Marine Corps Mountain Warfare Training Center's Summer Mountain Leader's Course. Marines with the school code M7A on their BIR/BTR are qualified. The current Summer Mountain Leader, designated by the unit

commander, is responsible for inventory, periodic serviceability checks, ordering replacement items through supply officer and supervising issue and recovery of items to ensure accountability and proper storage SOPs.

TRANSITION: Now that we have covered safety, are there any questions? Let's discuss how to prepare the MACK for use.

5. (15 Min) **PREPARING THE MACK FOR USE.**

a. Company Equipment:

- (1) Use the electric rope cutter to cut/whip one 15-18 foot sling rope for each Marine in the company, using the dynamic rope. Each Marine will also receive one non-locking carabiner and one locking carabiner.

**NOTE:** Finish one complete spool before cutting another spool.

- (2) Cut the static rope for the mission at hand. Some spools are already 300 feet and 165 feet (50m); others may be 600-foot spools. Cut one-inch tubular tape for static anchor cord (15-25 foot lengths). When static rope becomes unserviceable, cut out good sections of 15-25 foot lengths for static anchor cords. Cut 7mm nylon cord for use in tightening systems (3-6 foot lengths). Do not cut 7mm cord for company personnel to use as anchors because of the relatively low tensile strength (static rope or tape should be used only).

b. Team Equipment:

- (1) Rope: The dynamic climbing rope is olive drab and already in 165 foot (50m) lengths.
- (2) Cordage: Cut/whip 7mm nylon cord for use in tightening systems and anchors as part of each teams rack. Cut/whip one inch tubular tape of varying lengths for use as web runners. Tie loops using the water/tape knot, and range the size of the web runners from four to forty- eight inches. Tubular tape can also be used for anchors.
- (3) Racks: Use the 5.5 mm kevlar cord to wire the hexcentrics, secure the ends by tying a triple fisherman's knot. A knife will be needed to cut this cord because it will not burn. Use the electric rope cutter to whip the nylon sheath around the kevlar core. The knife blade will dull quickly when used to cut through the kevlar core. Use the kevlar cord for hexcentrics only (it is not pliable enough for use as utility cord, nor is there a large quantity provided). Tie a small loop of 7mm cord on the stitch plate (belay device) in the appropriate hole (to keep it from running down the rope during use and for racking it to the harness).
- (4) Silencing the rack can be done by wrapping vinyl tape around the non-locking carabiner bodies and the large (size 7-11) hexcentrics (ensure the tape is only one layer thick so that it will not interfere with the safe function of the item). Nut picks can be taped or dummy-corded so that they do not rattle on a carabiner.

- c. Tailor the preparation of the MACK to the mission, terrain, and size of using unit. Keep as much unused rope and cordage as possible for use as backup. Maintain a log of rope/cordage usage, and replace after two seasons of use or when unserviceable. Inspect frequently for serviceability (before, during and after use).

TRANSITION: Are there any questions concerning the preparations of a MAC Kit? If not, let's begin talking about after actions.

6. (5 Min) **AFTER ACTIONS.**

- a. Clean and dry all MACK components according to the respective instructions in the MACK's care and maintenance manual. Most importantly, ensure that all items are thoroughly DRY before returning items to the container for storage. One wet or damp item will spread its moisture to all other items in that container, causing mildew, rot, rust, etc. If carabiners are being oiled for long term storage, do not place them in the same container as any of the ropes/cordage.

TRANSITION: The MACK will only be as good as the effort spent on properly caring and maintaining this equipment. Time spent doing this is time well spent. Are there any questions?

**PRACTICE** (CONC)

- a. Students will apply this knowledge throughout the duration of the course.

**PROVIDE HELP** (CONC)

- a. The instructors will assist the students when necessary.

**OPPORTUNITY FOR QUESTIONS** (3 Min.)

1. **QUESTIONS FROM THE CLASS**

2. **QUESTIONS TO THE CLASS**

Q. What must be done to any item that becomes unserviceable or shows excessive signs of wear?

A. Replace it immediately.

Q. What is the kevlar cord provided in the MACK used for?

A. It is used for wiring the hexcentrics.



**SUMMARY**

(2

Min)

- a. What we have just discussed will ensure that we as Mountain Leaders will be able to accomplish those missions requiring the use of the MACK, and minimize placing our Marines in jeopardy.
- b. Those of you with IRF's please fill them out at this time and turn them in. We will now take a short break.

**UNITED STATES MARINE CORPS**  
Mountain Warfare Training Center  
Bridgeport, California 93517-5001

SML  
SMO  
ACC  
02/11/02

**LESSON PLAN**

**NOMENCLATURE AND CARE OF  
MOUNTAINEERING EQUIPMENT**

**INTRODUCTION**

(5 Min)

1. **GAIN ATTENTION.** Ropes, carabiners, and chocks are used to aid you and your unit when operating in a mountainous area. Their proper use can make your movement over cliffs, deep chasms and mountain rivers much easier. Use of this equipment incorrectly can inhibit your ability to move efficiently and in some cases cause serious injury or death to members of your unit.
2. **OVERVIEW.** The purpose of this period of instruction is to introduce you to the types of equipment used here and how to care for it so as to prevent its untimely failure. This lesson relates to all climbing and installation work that you perform here.

**INSTRUCTOR NOTE:** Have students read learning objectives.

3. **INTRODUCE LEARNING OBJECTIVES**

- a. **TERMINAL LEARNING OBJECTIVE.** In a summer mountainous environment, maintain mountaineering equipment, in accordance with the references.
- b. **ENABLING LEARNING OBJECTIVES (SML) and (ACC)**
  - (1) Given a diagram of a steel-locking carabiner and without the aid of references, label the parts of a carabiner, in accordance with the references.
  - (2) Without the aid of references, list in writing the advantages of nylon rope, in accordance with the references.
  - (3) Without the aid of references, list in writing the disadvantages of nylon rope, in accordance with the references.

(4) Without the aid of references, state in writing how much strength is lost when a rope is wet, in accordance with the references.

(5) Without the aid of references, list in writing the types of protection, in accordance with the references.

c. ENABLING LEARNING OBJECTIVES (SMO)

(1) Given a diagram of a steel-locking carabiner and without the aid of references, label the parts of a carabiner, in accordance with the references.

(2) Without the aid of references, list in writing the advantages of nylon rope, in accordance with the references.

(3) Without the aid of references, list in writing the disadvantages of nylon rope, in accordance with the references.

(4) Without the aid of references, state in writing how much strength is lost when a rope is wet, in accordance with the references.

(5) Without the aid of references, list in writing the types of protection, in accordance with the references.

4. METHOD/MEDIA. The material in this lesson will be presented by lecture and demonstration. You will practice what you have learned during upcoming field training exercises. Those of you with IRF's please fill them out at the end of the lecture.

5. EVALUATION.

a. SML – You will be tested by a written exam.

b. ACC – You will be tested by a written exam.

c. SMO – You will be tested by an oral exam.

TRANSITION: Does anyone have any questions on the purpose, learning objectives, how the class will be taught, and how you will be evaluated? We will begin by discussing the ropes used in the MAC kit.

BODY

(65 Min)

1. (10 Min) ROPES. All ropes used in the military must meet UIAA standards or U. S. Federal Test Standard 191A. Most ropes have a 5-year shelf life and maximum 2-year service life.

- a. Static. Black in color.
  - (1) Construction. Kernmantle
  - (2) Minimum tensile strength. 7500 lbs.
  - (3) Maximum elongation. 1.5%
  - (4) Diameter. 11mm
  - (5) Sizes.
    - (a) 165 ft  $\pm$  5 ft
    - (b) 300 ft  $\pm$  10 ft
  - (6) Usage. Rescue operations and bridging where a low amount of elongation is desirable under a working load.
  
- b. Dynamic. Olive Drab in color.
  - (1) Construction. Water-resistant treated Kernmantle to reduce friction.
  - (2) Minimum tensile strength. 6500 lbs.
  - (3) Maximum elongation. 6%
  - (4) Diameter. 10.5mm and 11mm
  - (5) Size. 165 ft  $\pm$  5 ft.
  - (6) Usage. For lead climbing/party climbing.
  
- c. Maxim Dry Rope. Olive Drab or Multi-Colored.
  - (1) Construction. Water-repellent treated Kernmantle.
  - (2) Minimum tensile strength. 3472 lbs.
  - (3) Maximum elongation. 6%
  - (4) Diameter. 9mm
  - (5) Size. 150 ft  $\pm$  5 ft
  - (6) Usage. For glacier travel/ice climbing
  
- d. Gold Line II.

- (1) Construction. Eight strand braided nylon plymor.
- (2) Minimum tensile strength. 4500 lbs.
- (3) Maximum elongation. 20%
- (4) Diameter. 11 mm
- (5) Size. 300 ft or 600 ft spools
- (6) Usage. Sling Ropes and litters only.



**Three strand twisted or laid rope.**

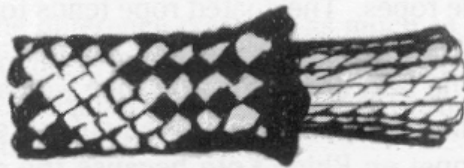

**Static, kernmantle rope showing core (kern) and sheath (mantle).**



**Dynamic, kernmantle rope used for rock climbing.**



**Double braid rope showing the braided sheath and braided core.**

**INSIDES AND OUTSIDE SHEATHS OF VARIOUS TYPES OF ROPES**

**NOTE:** Sling ropes are made from 15 foot lengths of plymor or dynamic rope ONLY. Twenty-five foot practice coils should be constructed with static rope, but dynamic rope can be used.

2. (5 Min) **ADVANTAGES/DISADVANTAGES**

a. Advantages of Nylon Rope

- (1) High strength to weight ratio.
- (2) Good energy absorption in dynamic ropes.
- (3) Flexible.
- (4) Rot resistant, not affected by frost.

b. Disadvantages of Nylon Rope

- (1) Low melting point. Nylon fuses at 400°F and melts at 480°F.
- (2) Susceptible to abrasions and cuts.
- (3) Affected by chemicals and light.

c. Advantages of Manila Rope

- (1) Easily gripped.
- (2) Hard wearing.
- (3) Does not deteriorate in heat.

d. Disadvantages of Manila Rode

- (1) Heavy, kinks, especially when wet. Absorbs water and swells.
- (2) Burns at +300°F.
- (3) Edible by rodents.

3. (3 Min) **GENERAL INFORMATION**

- a. Nylon rope stretches under tension and will rupture at between 30% and 70% elongation, depending on construction.
- b. Nylon rope loses as much as 30% strength when wet.
- c. Temperatures as low as 250°F will damage a nylon rope.

4. (5 Min) **NYLON WEBBING**

- a. The type of nylon webbing available is tubular. Tubular nylon webbing is very strong and flexible. All rules that apply to nylon rope apply to tubular nylon webbing. The size of nylon webbing used is:

- (1) 1 inch tubular nylon. Tensile strength approximately 4,000 - 4,500 lbs., depending on the manufacturer.

- b. Pre-sewn Spectra Runners. Tensile strength approximately 5,500 lbs.

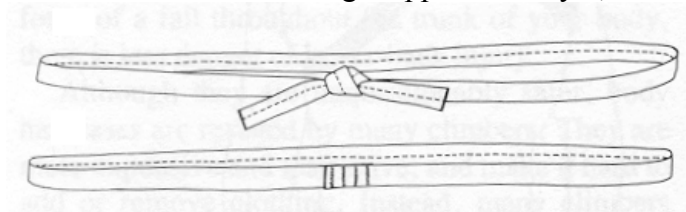

**NYLON WEBBING**

**NOTE:** These are minimum strengths. Some manufactures make even stronger webbing.

**TRANSITION:** We have just discussed general information in nylon webbing, are there any questions? Not only do we use ropes, but we also use carabiners in our installations, we will discuss the types of carabiners used:

- 5. (5 Min) **CARABINERS**. Also commonly known as snaplinks. Both locking and non-locking are used.

- a. **Purpose**. Carabiners are used for the following purposes:

- (1) To attach ropes or runners to pieces of protection.
  - (2) To attach the rappel rope to the rappel seat for seat-hip rappels or for crossing rope bridges.
  - (3) To attach the individuals safety rope to a safety line on a rope installation.
  - (4) To form field expedient pulley systems.

- b. **Nomenclature of a non-locking carabiner**

- (1) Gate
- (2) Gate pivot pin.
- (3) Locking pin.
- (4) Body.

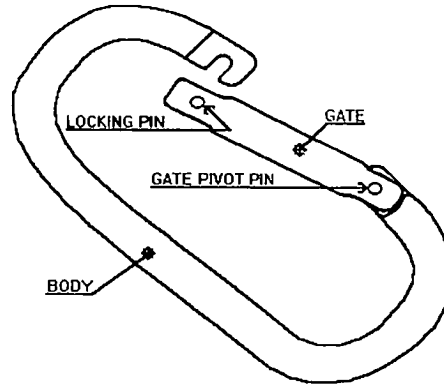

**NON-LOCKING ALUMINUM CARABINER**

c. Nomenclature of a locking carabiner

- (1) Gate.
- (2) Gate pivot pin.
- (3) Locking notch.
- (4) Locking nut.
- (5) Body.

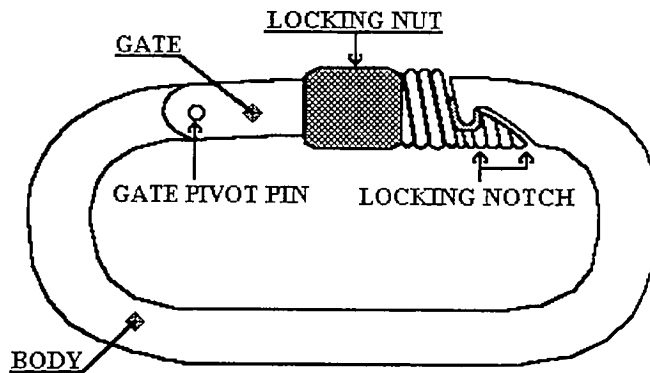

**STEEL LOCKING CARABINER**

d. There are two types of carabiners used. The two types and their characteristics are:

(1) Steel locking carabiners

(a) Large steel locking "D" (various manufacturers): Minimum tensile strength of 5,500 lbs.

(b) Steel-locking oval Stubai 82 is not in the MAC Kit and obsolete. However, it is being used at MWTC to save money, even though they are beyond the service life. Tensile strength of only 3,300 lbs.

(2) Aluminum non-locking carabiners



- (a) Aluminum non-locking oval (various manufacturers): minimum tensile strength of 4,200 lbs.
- e. Serviceability Check for a Carabiner. The following steps are used for you to check a carabiner for serviceability:
  - (1) The gate snaps shut with no friction and with no gap between the locking pin and locking notch.
  - (2) There is no excessive side to side movement of the gate.
  - (3) The pivot pin is tight.
  - (4) The locking pin is tight.
  - (5) The locking nut travels freely and locks securely.
  - (6) There are no cracks or flaws in the metal.

**NOTE:** The weakest part of a carabiner is the gate. If an engraver is used to mark a carabiner, it should be applied to the gate and not the load bearing side.

- f. Preventive Maintenance for a Carabiner.
  - (1) Remove all dirt, moisture and grime.
  - (2) Lubricate with tri-flow graphite and clean off thoroughly.

**NOTE:** Whenever you use a locking carabiner ensure that the locking nut is always locked down (tightened).

- 6. (2 Min) **CARE OF THE CARABINER**. Do not drop the carabiner as this may result in either actual damage to the carabiner or in dirt getting into the workings of the carabiner and damaging it.

**TRANSITION:** We have covered the parts, the strength, and care of carabiners; are there any questions? Now lets move on to chocks.

7. (10 Min) **PROTECTION**

- a. **Purpose**

- (1) Protection or pro is used to protect climbers as they ascend a cliff face. This is accomplished by wedging them into cracks and openings in the rock and securing the rope to them. Since they can be slid into the rock without banging, they are not noisy to install and are very suitable for a tactical situation that may require silence.

(2) A disadvantage of pro is that it is directional. That is, when it is installed it is wedged into a crack and is meant to take a strain in a specific direction. If you climb above your pro and inadvertently pull the rope, you may pull your pro all or part way out of the crack that you installed it in.

b. Types

(1) Stoppers. These have a wedge-shaped structure and are designed to be used in small cracks. They come in twelve sizes, ranging from widths of 0.16 inches (# 1) to 0.90 inches (# 12). The sides of the wedged portion are slightly beveled, enabling the climber to insert the same stopper into a crack two different ways.

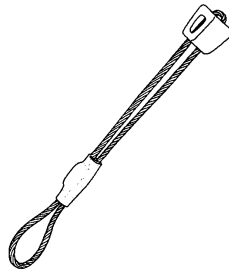

**STOPPER**

(2) Hexcentrics. These chocks have a six-sided structure shaped like a hexagon; the sides being of unequal width, which allows the same chock to be inserted in different size cracks depending on which way it is inserted. These chocks come in various sizes and are used in larger cracks that stoppers are too small for.

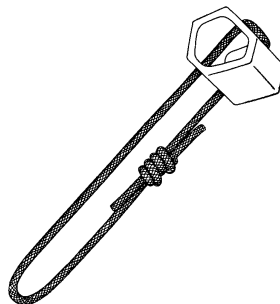

**HEXCENTRIC**

(3) Spring Loaded Camming Devices (SLCD). Spring loaded camming devices are a unique solution for shallow, horizontal or vertical cracks, thin "tips" cracks and narrow pockets where other types of protection can't be placed. This is an advantage over rigid camming devices, which can only be placed in a vertical crack.

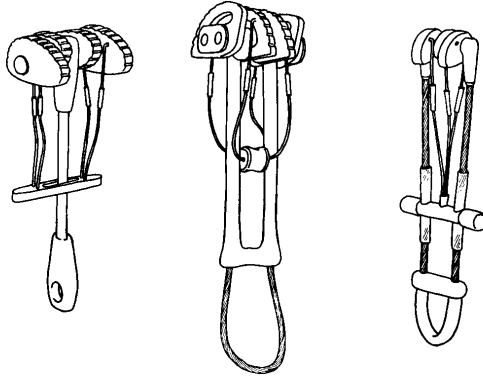

### **SPRING LOADED CAMMING DEVICES**

#### c. Serviceability Check

##### (1) Stoppers and Hexcentrics

- (a) Check holes used for stringing chocks for burrs that could damage the cord the chocks are strung with.
- (b) Check accessory cord for wear, fraying, rupture of the outer sheath, and knot.
- (c) If wired, check wires for frays that could damage climbing rope.
- (d) If wired, check soldered (or otherwise joined) area for cracks or looseness.
- (e) Check nut for splits or cracks.

##### (2) SLCD's

- (a) Ensure wires leading from trigger to cam are not bent or frayed.
- (b) Check to ensure that cam movement is free and easy and for contraction and expansion by pulling and releasing trigger.
- (c) Check that runner is not frayed and no stitches have popped.
- (d) If it is stiff or corroded by sea water, spray with Tri-Flow Graphite and clean off thoroughly.

#### d. Strengths

- (1) The strength of a chock depends on the manufacturers specifications and on the type and size of material used for the sling (rope, webbing, or wire). Below are the strengths of some of the types of chocks used at MWTC.

<b>TYPE</b>	<b>STRENGTH</b>
#1 / #2 Stopper - wired	350 kg (approx. 770 lbs.)
#3 - #5 Stopper - wired	650 kg (approx. 1430 lbs.)
#6 - #12 Stopper - wired	1,100 kg (approx. 2420 lbs.)
#1 - #3 Hexcentrics - wired	1,100 kg (approx. 2420 lbs.)

- (2) Hexcentrics #4 thru #10 are only strung with Type I cord. Type II cord is used for Prusik cordage. The following are the cord specifics:

<b>TYPE</b>	<b>DIAMETER</b>	<b>CONSTRUCTION</b>	<b>STRENGTH</b>	<b>LENGTH</b>
I	5.5mm	Spectra Kevlar	4,400	150 ft ± 10 ft
II	7mm	kernmantle	2,200	300 ft ± 10 ft

- (3) SLCD's vary in strength depending on the manufacturer, as well as the size.

<b>TYPE</b>	<b>MIN STRENGTH</b>
Camming Device Large	2,400 lbs.
Camming Device Small	2,600 lbs.

e. Care of Pro

- (1) When placing pro, insure that the cord or wire does not rub against the rock.
- (2) Do not drop pro, which may deform it, or the accessory cord that the pro is strung with, which may lead to deterioration of the cord.

8. (10 Min) **OTHER EQUIPMENT USED IN MOUNTAINEERING**

- a. **CAVING LADDER**. Constructed of stainless steel cables and aluminum crossbars. Several ladders can be connected together by the use of two large steel rings on each end of the ladder.

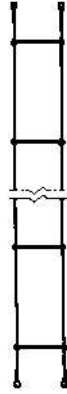

**CAVING LADDER**

- b. **ASCENDER**. Easily placed and removed from a rope with one hand and allows the rope to run through it in one direction while it grips in the other. A safety device is incorporated to ensure that the cam only releases the rope when the trigger is pressed and out of position.

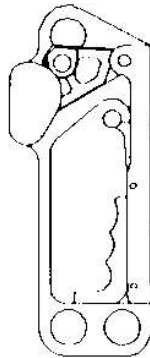

**ASCENDER**

- c. **RESCUE PULLEY**. Has two independent side plates that enable a user to insert the rope onto the wheel without having to thread the rope through. The pulley is large enough to accommodate a 1/2 inch rope and has an eyehole large enough to accommodate two steel locking carabiners.

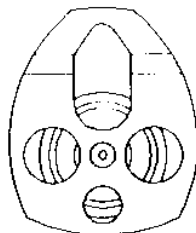

**RESCUE PULLEY**

d. HELMETS. Worn to protect the head from falling rocks and from hitting rocks should you fall. Check helmet for cracks or chips and a good chinstrap. The climbing helmet used at MCMWTC is the Joe Brown Light Weight Helmet.

e. BELAY DEVICES.

(1) Uses. Various devices used as a rappelling or belay device. They should be used with a locking carabiner only.

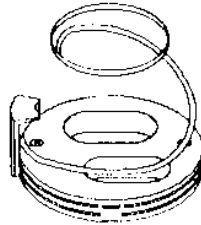

**STITCH PLATE**

(2) Construction. Made from a heat-dissipating aluminum alloy so device is cool to touch after a fast running rope has passed through it. (User and rope friendly). Care must be taken not to bang or throw these devices onto any hard surface or damage may occur.

9. (5 Min) **RACKING EQUIPMENT**

a. Protection, quick draws and other equipment should be organized on the climbing harness. Gear should be silenced and should not interfere with the climber's movement, i.e. a web runner gets caught on the climber's foot, or on rocks and vegetation as he approaches the cliff face. The gear should be easily accessible for either hand, and the climber should know where it is on the harness. This will be covered in more detail in PLACING PROTECTION.

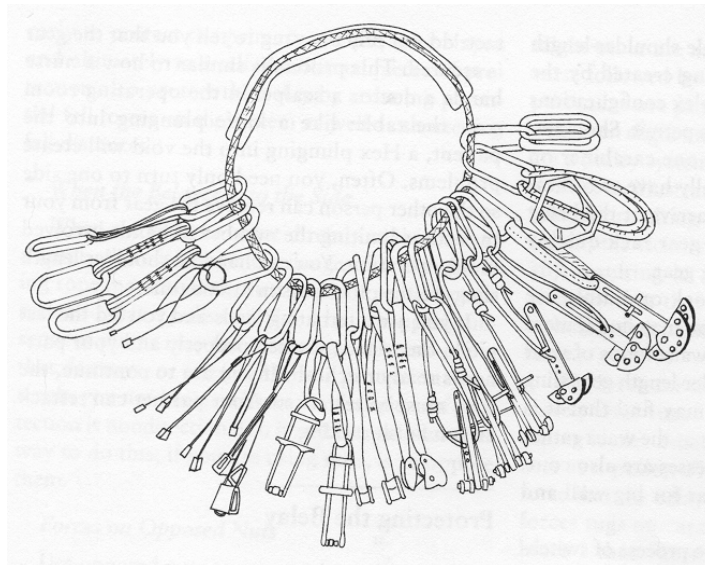

**CLIMBING RACK**

**PRACTICE**

(CONC)

- a. Students will properly care and maintain mountaineering equipment.

**PROVIDE HELP**

(CONC)

- a. The instructors will assist the students when necessary.

**OPPORTUNITY FOR QUESTIONS**

(3 Min.)

**1. QUESTIONS FROM THE CLASS**

**2. QUESTIONS TO THE CLASS**

Q. What are the five parts of a locking carabiner?

- A. (1) Gate
- (2) Gate pivot pin
- (3) Locking notch
- (4) Body
- (5) Locking nut (locking carabiner only)

Q. Name the three types of pro used.

- A. (1) Stoppers
- (2) Hexcentrics
- (3) Spring Loaded Camming Devices (SLCD)

**SUMMARY**

(2 Min)

- a. During this period of instruction we have covered, ropes, carabiners, chocks, and helmets. We have discussed their nomenclature, care/maintenance and purposes.
- b. Those of you with IRF's please fill them out and turn them in. We will now take a short break until our next class.

**UNITED STATES MARINE CORPS**  
Mountain Warfare Training Center  
Bridgeport, California 93517-5001

SML  
SMO  
ACC  
02/11/02

**LESSON PLAN**

**ROPE MANAGEMENT**

**INTRODUCTION**

(5 Min)

**SMO INSTRUCTOR NOTE:** This class is taught outside the gym. Have a rope corral setup that is large enough for a company. You will need at least two assistants to demonstrate and help check knots.

- 1. GAIN ATTENTION.** Movement over mountainous terrain in a summer mountainous environment cannot always be accomplished by an individual, a party, or a unit without the use of special equipment. The trained military mountaineer soon learns the value of his rope, and what it means if that rope is either not available or has become unserviceable due to abuse. If the rope is treated properly and with care, the rope could save your life.
- 2. OVERVIEW.** The purpose of this period of instruction is to familiarize the student with the basics of rope management, especially those aspects of terminology, considerations in the care of rope, methods of coiling ropes, when to use each coil, the types of knots used, and the classification of knots. This lesson relates to all installations and climbing performed here at MWTC.

**INSTRUCTOR NOTE:** Have students read learning objectives.

**3. INTRODUCE LEARNING OBJECTIVES**

- a. TERMINAL LEARNING OBJECTIVE.** In a summer mountainous environment, utilize rope management, in accordance with the references.
- b. ENABLING LEARNING OBJECTIVES (MLC) and (ACC)**
  - 1. )** Without the aid of references and given a list of rope terminology, define in writing, in accordance with the references.
  - 2. )** Without the aid of references, list in writing the rope care considerations, in accordance with the references.



3 )In a summer mountainous environment and given a climbing rope, execute the methods of coiling a rope, in accordance with the references.

4 )In a summer mountainous environment and given a sling rope and a designated amount of time while blindfolded, tie the mountaineering knots, in accordance with the references.

**c. ENABLING LEARNING OBJECTIVES (SMO)**

1 )With the aid of references and given a list of terms used in rope work, state orally the terminology, in accordance with the references.

2 )With the aid of references, state orally the considerations in the care of rope, in accordance with the references.

3 )In a summer mountainous environment and given a climbing rope, execute the methods of coiling a rope, in accordance with the references.

4 )In a summer mountainous environment and given a sling rope and a designated amount of time, tie the mountaineering knots, in accordance with the references.

4. **METHOD/MEDIA.** The material in this lesson will be presented by lecture and demonstration. You will practice what you have learned during upcoming field training exercises. Those of you with IRF's please fill them out at the conclusion of this lesson.

5. **EVALUATION.**

a. MLC - You will be tested later in the course by written and performance evaluations on this period of instruction.

b. ACC - You will be tested later in the course by written and performance evaluations on this period of instruction.

c. SMO - You will be tested later on by a verbal and performance examination. A timed knot test will also be administered also.

**TRANSITION:** Are there any questions over the purpose, learning objectives, how the class will be taught, or how you will be evaluated? Now that we know what is expected, it is important for all to know and use the same terminology so that everyone is sure of what is being said to prevent confusion and mistakes. Let us start with some common rope terminology.

**BODY**

(80 Min)

**1.** (5 Min) TERMS USED IN ROPE WORK

- a.** Bight. A simple bend in the rope in which the rope does not cross itself.

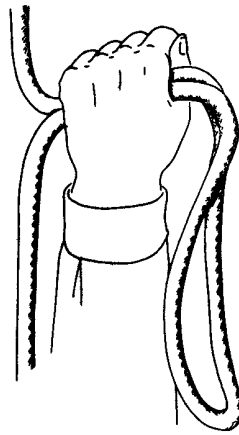

**BIGHT OF ROPE**

- b.** Loop. A simple bend in the rope in which the rope does cross itself.

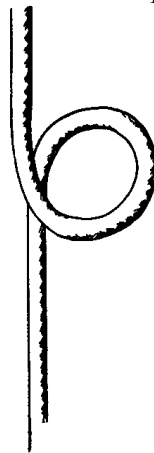

**LOOP**

- c.** Half Hitch. A loop which runs around an object in such a manner as to bind on itself.

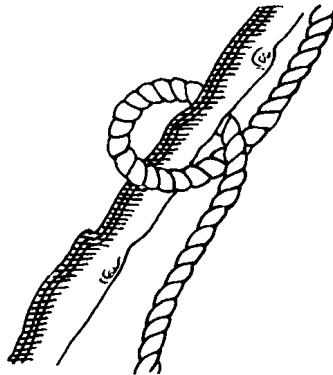

**HALF HITCH**

- d.** Standing End. The part of the rope which is anchored and cannot be used, also called the static end.

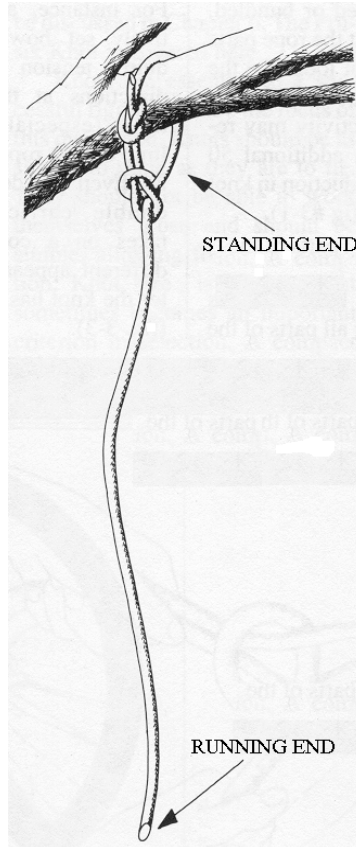

- e. Running End. The free end of the rope which can be used.
- f. Lay. The same as the twist of the rope. (Applies only to hawser laid ropes, such as manila.)
- g. Pigtail. The short length left at the end of a rope after tying a knot or coiling a rope. It may or may not be tied off with a secondary knot, depending on the circumstance.

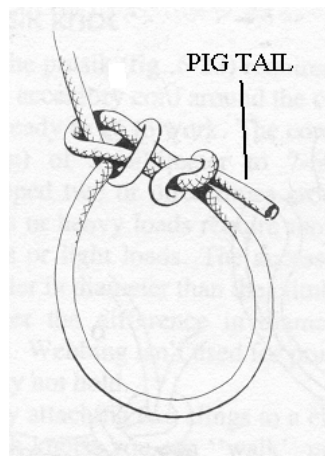

**PIG TAIL**

- h. Stacking (or Flaking). Taking off one wrap at a time from a coil, and letting it fall naturally to the ground.



**FLAKED OUT ROPE ON THE GROUND**

- i** Dressing the knot. This involves the orientation of all of the knot parts so that they are properly aligned, straightened, or bundled, and so the parts of the knot look like the accompanying pictures. Neglecting this can result in an additional 50% reduction in knot strength.

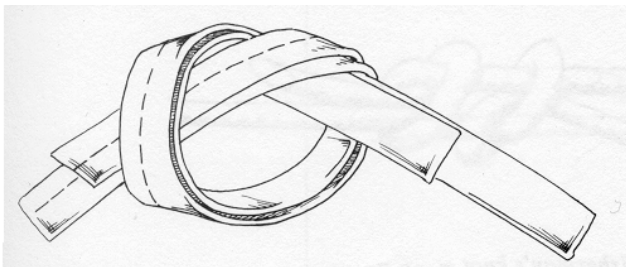

**NON-DRESSED DOWN WATER TAPE KNOT**

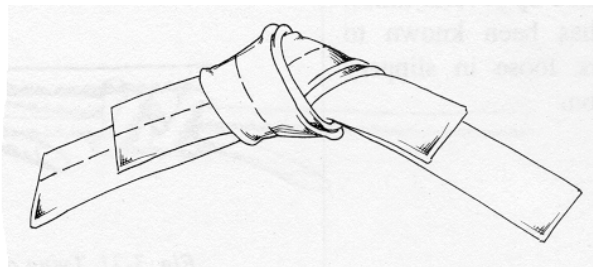

**DRESSED DOWN WATER TAPE KNOT**

- j** Setting the knot. This involves tightening all parts of the knot so that all of the rope parts bind upon other parts of the knot so as to render it operational. A loosely tied knot can easily deform under strain and change character.

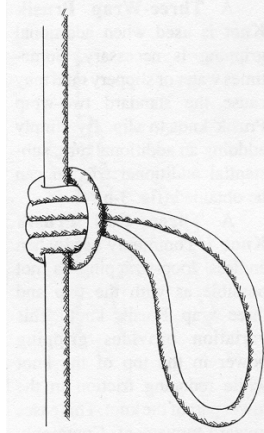

**A FULLY SET PRUSIK KNOT**

**TRANSITION:** Are there any questions over the terminology? Since the rope is the climber's lifeline it deserves a great deal of care and respect. Next we will talk about the considerations for the care of the rope and rope log.

**2. (10 Min) CONSIDERATIONS FOR THE CARE OF ROPE**

- a.** The rope should not be stepped on or dragged on the ground unnecessarily. Small particles of dirt will get into and through the sheath causing unnecessary wear to the rope within.
- b.** The rope should never come in contact with sharp edges of any type. Nylon rope is easily cut, particularly when under tension. If a rope must be used around an edge which could cut it, then that edge must be padded or buffed using fire hose if available, or several small sticks.
- c.** Keep the rope as dry as possible. If it should become wet, hang it in large loops, above the ground, and allow it to dry. A rope should never be dried out by an open flame, or be hung to dry on metal pegs, as this will cause rust to get in the rope thus rendering it unserviceable.
- d.** Never leave a rope knotted or tightly stretched longer than necessary.
- e.** When using rope installations, never allow one rope to rub continually against another.

**NOTE:** With manila ropes this will cause the rope to fray, whereas nylon ropes can melt under the friction that this causes.

- f.** The rope should be inspected prior to each use for frayed or cut spots, mildew, rot or defects in construction.
- g.** Mark all climbing ropes at their midpoints to facilitate establishing the midpoint for a procedure requiring you to use the middle of the rope. The rope should be marked with a

bright colored adhesive tape.

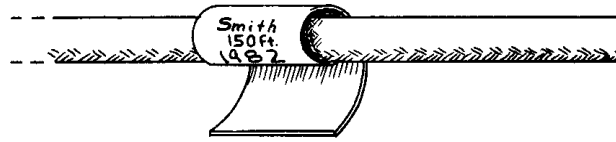

#### **MARKING THE MIDDLE OF THE ROPE**

- h.** The rope should not be marked with paints or allowed to come in contact with oils or petroleum products for these products will weaken it.
- i.** A climbing rope should NEVER be used for any other purpose except for mountaineering, i.e., towing vehicles.
- j.** The ends of a new rope or ends caused by a cut should be cut with the rope cutter contained in the MACK and marked with a serial number.

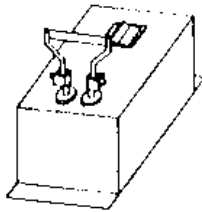

#### **ROPE CUTTER**

- k.** The rope should never be subjected to high heat or flame as this can significantly weaken it.
- l.** To clean rope use mild soap and rinse thoroughly with water. A rope washer can be used to clean or rinse the rope.

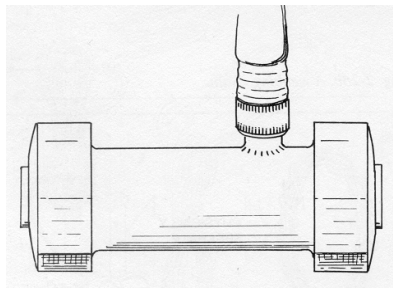

#### **ROPE WASHER**

- m.** When not in use, ropes should be coiled and hung on wooden pegs rather than on nails or any other metal object. They should be stored in a cool place out of the direct rays of the sun.
- n.** When in areas of loose rock, the rope must be inspected frequently for cuts and abrasions.
- o.** Always maintain an accurate Rope Log whenever using a rope.

p. Ropes 300-600 foot in length should be Mountain Coiled.

3. (10 Min) **INSPECTION OF ROPE**

a. All ropes have to be inspected before, during, and after all operations. Kernmantle rope is harder to inspect than a laid rope. I.e. green line. The Assault Climber must know what to look and feel for when inspecting a rope. Any of the below listed deficiencies can warrant the retirement of a rope.

1 ) **Excessive Fraying**. Indicates broken sheath bundles or PIC breakage.

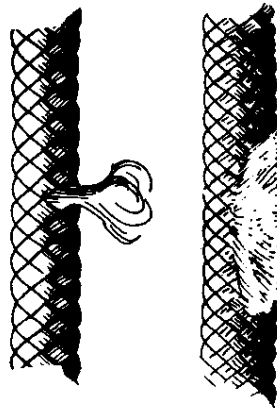

**DAMAGED AND EXPOSED ROPE**

2 ) **Exposed Core Fibers**. Indicates severe sheath damage. (When you can see the inner core fibers)

3 ) **Glossy Marks**. Signify heat fusion damage, also called a booger.

4 ) **Uniformity of Diameter / Size**. May indicate core damage, noted by an obvious depression (hour glass) or exposure of white core fibers protruding from the sheath (puff).

5 ) **Discoloration**. A drastic change from the ropes original color may indicate chemical change or damage.

6 ) **Stiffness or Soft Spots**. Could signify core damage.

**NOTE:** Dynamic ropes measuring between 10mm and 12mm are marked at each end of its pigtails with a number “1” indicating that the rope is UIAA approved for single rope lead climbing. Dynamic ropes measuring between 8mm and 9mm are marked at each end of its pigtails with a “1/2” number indicating that two of these ropes are required to conduct a lead climb.

4. (5 Min) **ROPE LOG**. The purpose of the Rope Log is to maintain an accurate record for the use of each rope contained within the Marine Assault Climbers Kit (MACK). Due to the

turnover of personnel, and the fact that no one person may have the same rope twice, the rope log is used to ensure the safe use, serviceability, and account of each rope.

**a.** Serial number. By assigning each rope a serial number, responsible units can determine information about a rope. As soon as the ropes are cut to the desired length for their intended purpose, each rope will be assigned a serial number by the responsible unit. That rope should then be labeled with that serial number in some permanent manner. The best method for this is as soon as the ends of the new rope have been whipped and fused, mark both ends of the rope with the serial number and then dip the ends of the rope, in effect, laminating the serial number to the rope ends.

**1** ) A rope serial number has five parts. The proper format for a rope serial number is as follows:

- 1.** Type of rope: (S) - Static or (D) - Dynamic.
- 2.** Last two digits of the year the rope was manufactured. Each rope has a shelf life of two years, after that it must not be used for any mountaineering purpose.
- 3.** Four-digit number for that individual rope which is assigned by the responsible unit, and should be assigned sequentially as new ropes are issued out.
- 4.** The length and diameter of the rope. The length may be recorded in feet, and the diameter in millimeters.
- 5.** Responsible unit code. Example: S-96-0001-150/11mm-F2/8

Example meaning: This rope is a 150 foot, 11mm, static rope, manufactured in 1996. It is the first rope issued by Fox Co 2/8.

**b.** Recording Information in a Rope Log. Once a new rope has been serialized, the rope log for that rope should be started up. At a minimum, it should contain the following information:

- 1** ) The rope serial number.
- 2** ) Manufacturer. Depending on the manufacturer, ropes of the same type and diameter may vary in tensile strength, stretch factor, and durability.
- 3** ) Date of manufacture. Five years from this shelf life date, ropes are considered to have reached their normal expiration date, and should be destroyed.
- 4** ) Date in service. This is to be recorded for tracking purposes to establish how long a rope is in service. Two years is considered maximum rope life in service.
- 5** ) Each time a rope is used, the using unit is responsible to record how that rope was used and how much use the rope received. Additionally, before checking out a rope



and prior to turning it back in, the rope must be inspected by qualified personnel, and initial in the "Inspected By" block of the rope log.

**NOTE: ANY TIME A DYNAMIC ROPE IS SUBJECTED TO A FALL FACTOR 2, THAT ROPE SHOULD NOT BE USED AGAIN FOR MOUNTAINEERING.**

DYNAMIC					
SERIAL #					
MANUFACTURER					
DATE OF MANUFACTURE					
DATE IN SERVICE					
INDICATE THE DATE AND NUMBER OF EACH SPECIFIC USE					
CLIMBS	FALLS (FACTOR)	TOP ROPES	RAPPELS	REMARKS	INSPECTED BY

**ROPE LOG**

TRANSITION: Are there any questions over the care of a rope or rope log? Now let's discuss the various ways of coiling a rope.

**5.** (10 Min) **COILING A ROPE.** There are two types of rope coils frequently used at MWTC. The Mountain Coil and the Butterfly Coil.

**a.** Mountain Coil. This coil is useful for carrying the rope over a pack or over a climber's shoulder and neck. It can be used for short time storage. The mountain coil can be tied in the following manner:

**1** ) Sit down with your leg bent at a 90-degree angle, heel on the deck. Starting at one end, the rope is looped around the leg in a clockwise fashion, going over the knee and under the boot sole until the entire rope is coiled.

**2** ) If coiling a 150-foot rope, use only one leg and offset the other, when coiling a 300-foot rope, use two legs and keep them together.

**3** ) With the starting end of the rope, form a 12-inch bight on the top of the coils.

**4** ) Uncoil the last loop and along the top of the coils, wrap 4-6 times towards the closed end of the bight.

**5** ) The end of the rope being wrapped is then placed through the closed end of the bight.

**6** ) The running end of the bight is then pulled snugly to secure the coil.

**7** ) To prevent the coil from unraveling, the two pigtails are tied together with a square

knot.

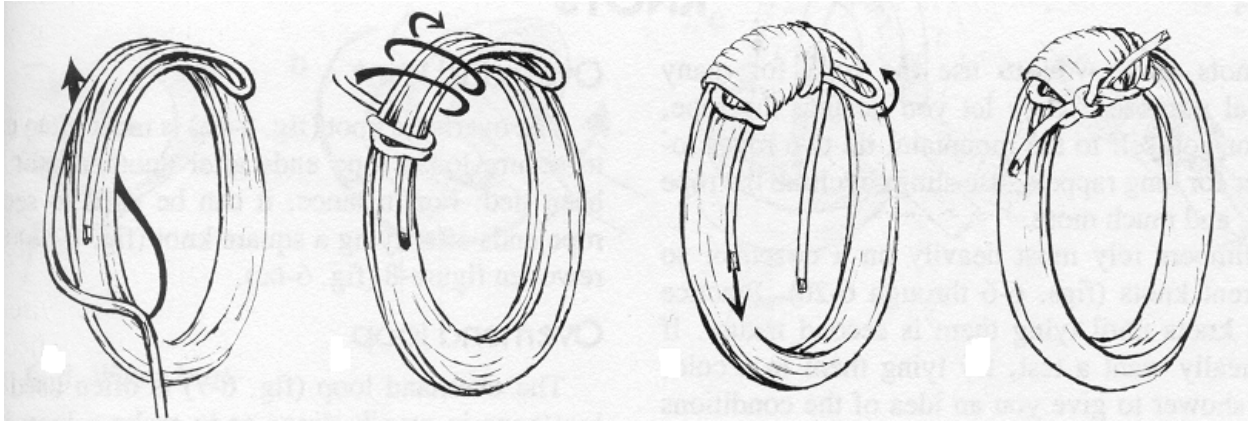

MOUNTAIN COIL

- b.** Butterfly Coil. This method is used for carrying a rope when the individual needs to have maximum use of his upper body, (i.e. while climbing), without the encumbrance of a large rope coil hanging across his chest.

(1) Coiling the Butterfly Coil

- a)** Step 1: Find the middle of the rope, then form a three foot bight laying both ropes in the upraised palm at the two foot point.

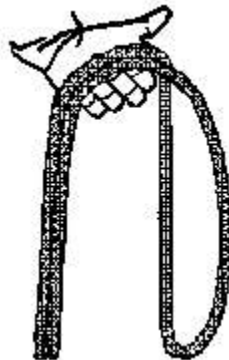

STARTING THE BUTTERFLY COIL

- b)** Step 2: Form another two-foot bight with the running end. Place the rope at the two-foot bight along side on top of the original bight ensuring the running end is on the same side as the original bight.
- c)** Step 3: Continue making two foot bights, laying them alternately into your palm until there is only six to eight feet remaining. At that point, begin wrapping the two pigtails horizontally four to six times at the mid way point of the ropes in a bight from bottom to top.

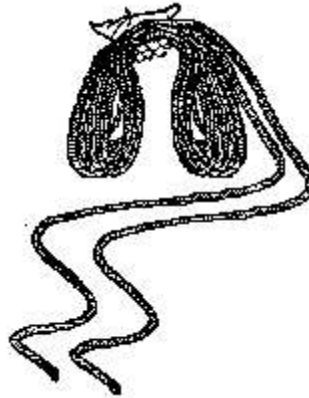

**TWO FOOT BIGHTS ON BOTH SIDES WITH 6 TO 8 FEET REMAINING**

- d) Step 4: After completing your wraps, form a bight with the remaining pigtail and then thread it underneath your palm and upwards to one-foot above the coiled rope.
- e) Step 5: With the remaining pigtail, thread it through the one-foot bight in step four.

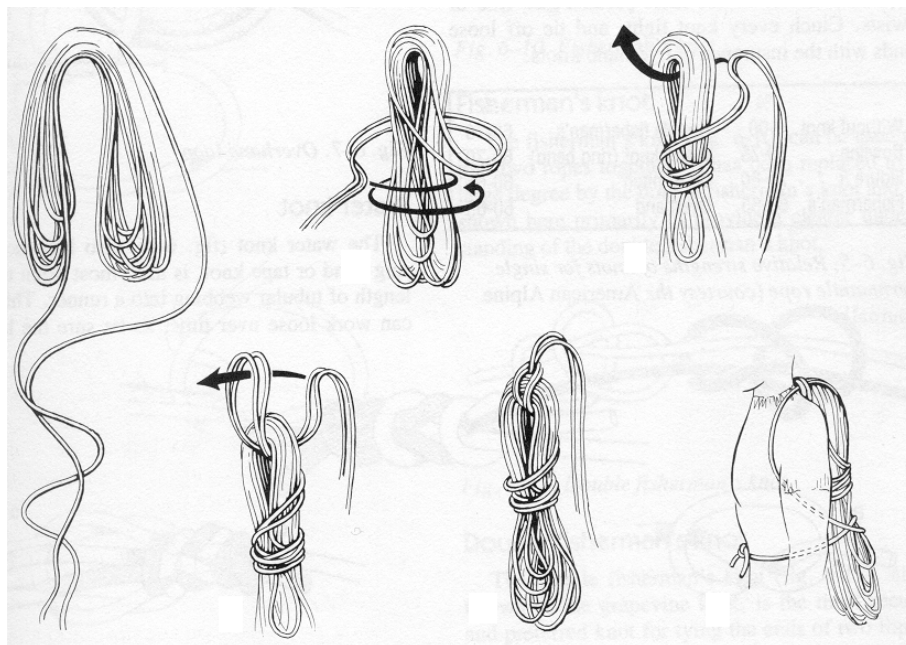

**TYING AND CARRYING THE BUTTERFLY COIL**

- 2) Carrying the Butterfly coil. Separate the running ends, placing the coil in the center of the back of the carrier, then run the two ends over his shoulders so as to form shoulder straps. The running ends are then brought under the arms, crossed in the back over the coil, brought around the body of the carrier and tied off with a square knot at his stomach.

TRANSITION: Are there any questions over coiling and securing a rope? Now let's discuss

how to throw the rope down the cliff face.

6. (5 Min) **ROPE THROWING.** To insure that the rope will not get tangled when deployed, certain steps must be taken.
  - a. With a stacked rope, anchor off the standing end.
  - b. Take the opposite end of the rope and make 6-8 coils and place them in your strong arm. These wraps will serve as a throwing weight that you can aim.
  - c. 10-15 feet from the strong-arm coils create a second set of 6-8 wraps and place them in your weak arm.
  - d. From the edge of the cliff, sound off with the command “STAND-BY FOR ROPE”. Just before you release the coils, sound off with the command “ROPE”. At that time drop the weak arm coils from the cliff.
  - e. While taking aim, throw your strong-arm coils overhand or sidearm hard enough to hit your intended target.
  - f. If the throw was misdirected due to wind, tree, etc., reorganize and attempt to re-deploy the rope.

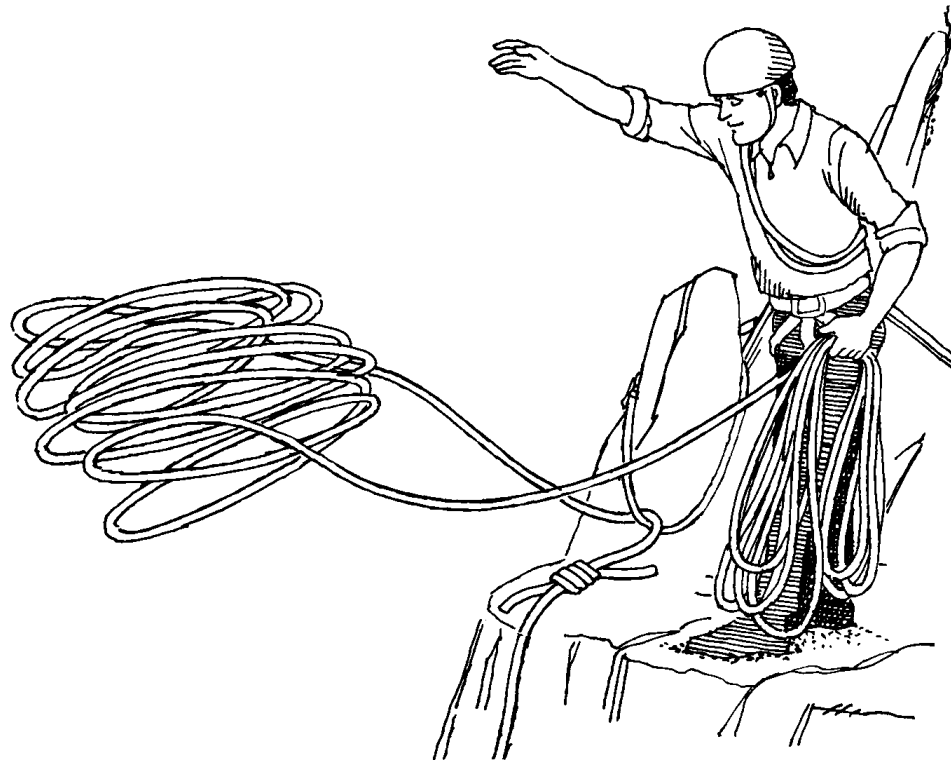

**THROWING THE ROPE**

**TRANSITION:** Are there any questions over throwing the rope? Take a 5 minute break and then

get around the rope corral with your sling rope. Now we will discuss mountaineering knots, their uses, and how to tie them.

**SMO INSTRUCTOR NOTE:** Tell the company that you will cover as many knots as time allows. All other knots will be taught by that company's instructor team throughout the core package.

6. (25 Min) **MOUNTAINEERING KNOTS.**

**a. Class I – End of the Rope Knots**

**1**) **Square Knot.** Used to tie ends of two ropes of equal diameter together. It should be secured by overhand knots on both sides of the square knot.

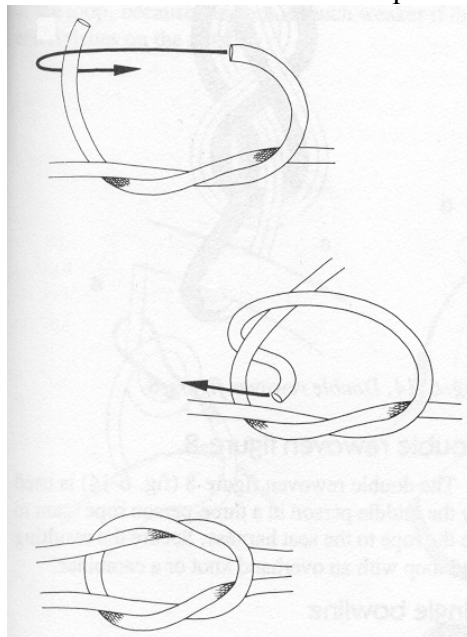

**SQUARE KNOT**

**2**) **Double Fisherman's Knot.** It is a self-locking knot used for tying two ropes of equal diameter together. It can be tightened beyond untying.

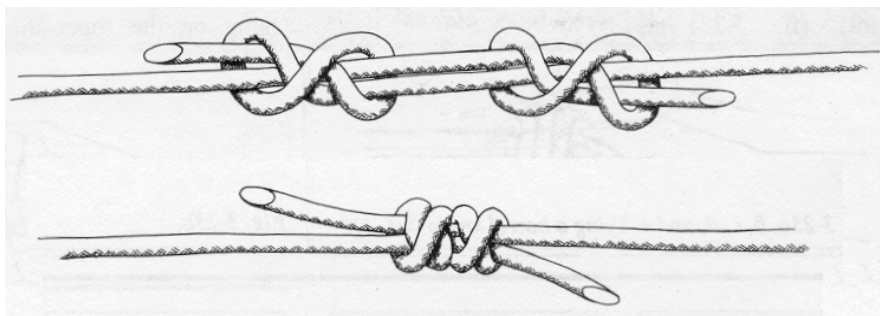

**DOUBLE FISHERMAN'S KNOT**

**3**) **Water/Tape Knot.** Used to secure webbing or tape runners. It is constructed by tying an overhand knot (without twists) in one end of the tape, and threading the other end

of the tape through the knot from the opposite direction. After the knot is dressed down, each pigtail should be a minimum of two inches long.

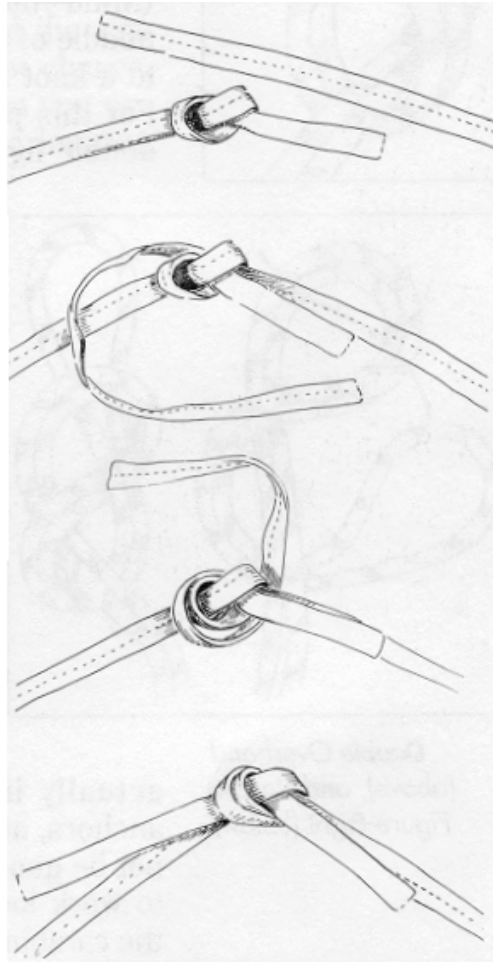

**WATER TAPE KNOT**

- 4 ) **Double Sheet Bend**. Used to tie the ends of two or more ropes of equal or unequal diameter together.

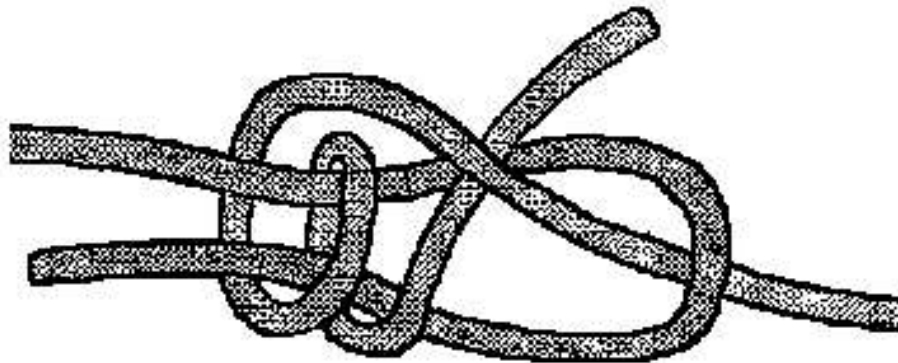

**SHEET BEND**

- b. **Class II - Anchor Knots**

- 1) Bowline. Used to tie a fixed loop in the end of a rope. This knot is always tied with the pigtail on the inside and secured with an overhand knot.

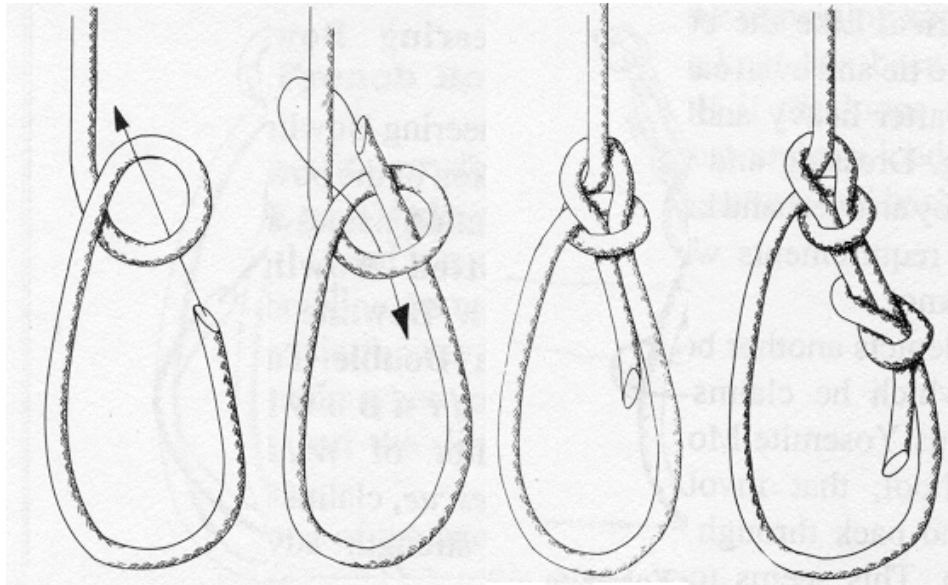

**BOWLINE**

- 2) Round Turn with Two Half Hitches or a Bowline. A loop which runs around an object in such a manner as to provide 360 degree contact and may be used to distribute the load over a small diameter anchor. It will be secured with two half hitches or a bowline.

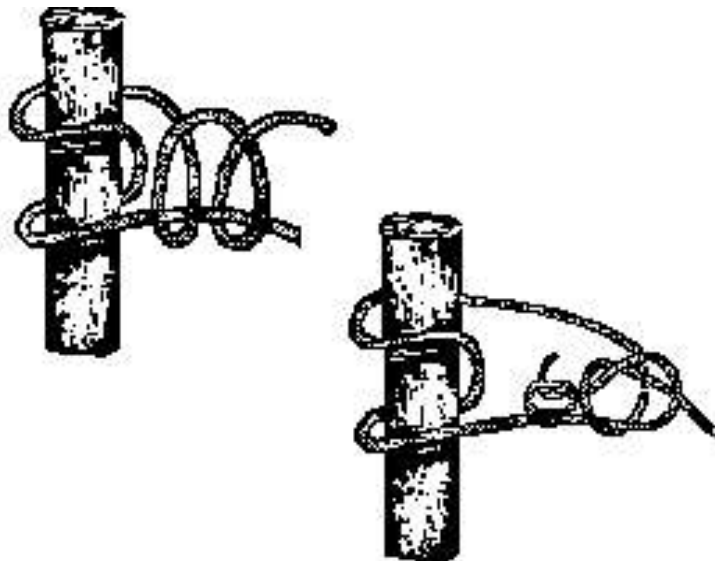

**ROUND TURN AND TWO HALF HITCHES AND**

**ROUND TURN AND A BOWLINE**

- 3) Clove Hitch. This knot is an adjustable hitch. It could be considered a middle-of-

the-rope anchor knot at the end-of-the-rope when used in conjunction with a bowline or round turn and two half hitches.

**1**) Around-the-object Clove Hitch.

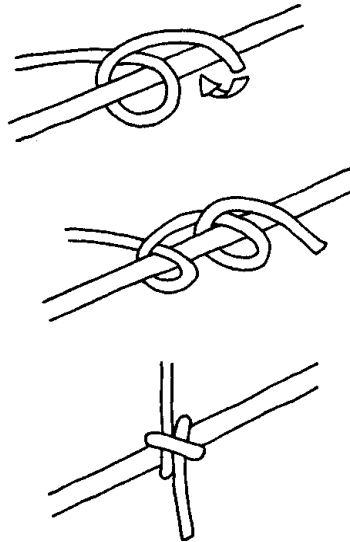

**AROUND THE OBJECT CLOVE HITCH**

**2**) Over-the-object Clove Hitch.

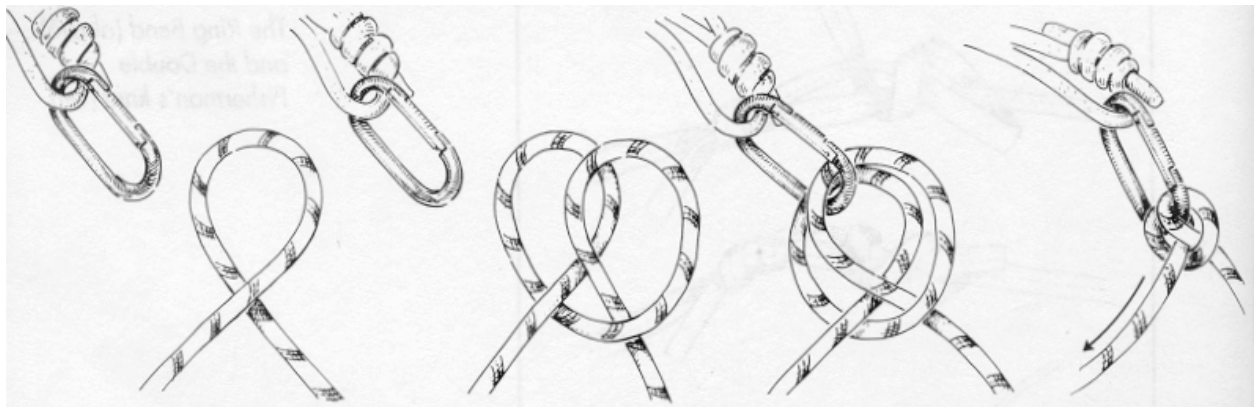

**OVER THE OBJECT CLOVE HITCH**

**c.** Class III - *Middle-of-the-rope*

**1**) Figure-of-Eight-Loop. This is a strong knot that can be readily untied after being under load.



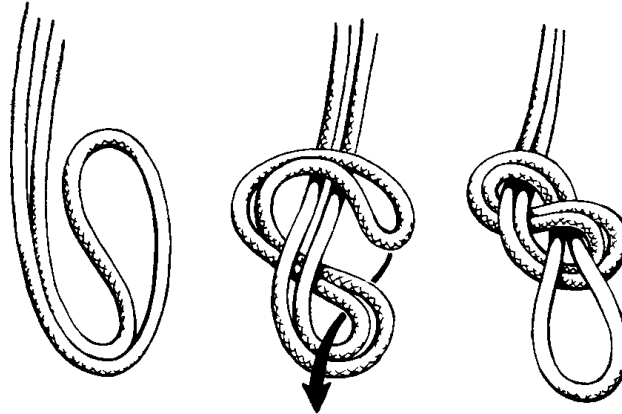

**FIGURE 8 LOOP**

**2**) **Double Figure of Eight Loop.** The double Figure of Eight Loop is a strong knot and the double loop reduces the wear and strength loss from the rope bending around the carabiner by splitting the load between the two loops.

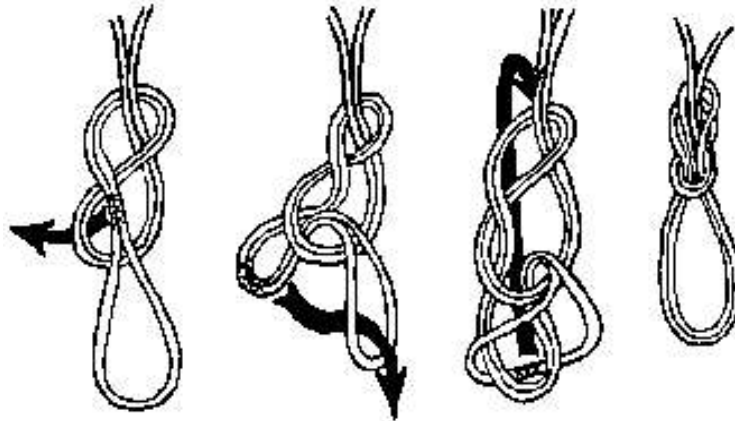

**DOUBLE FIGURE 8 LOOP**

**3**) **Two Loop Bowline.** This knot can be used to construct a self-equalizing belay or to tie the middle person in on three people on a rope.

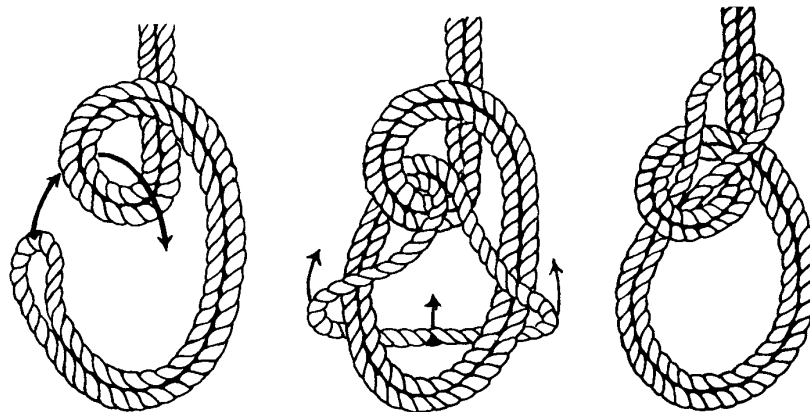

**TWO LOOP BOWLINE**

**d.** *Class IV - Special Knots*

**1.)** Prusik Knot. This knot functions by introducing friction that can be alternately set and released. For best results, tie the knot with a smaller diameter cord on a larger diameter cord. If slippage occurs, more wraps maybe used.

**a)** Middle-of-the-Rope Prusik. This knot is created with an endless loop also known as a Prusik Cord. Do not tie this knot with tape due to less friction.

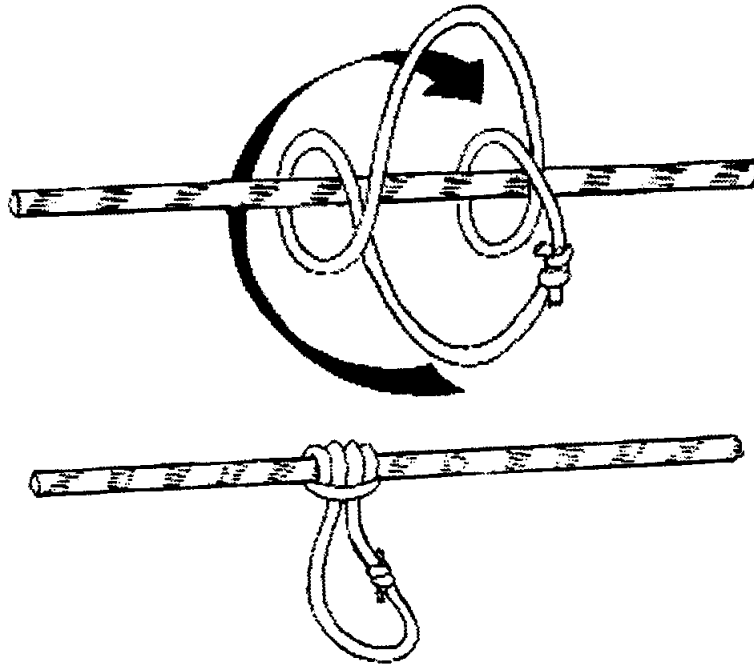

**MIDDLE OF THE LINE PRUSIK**

**b)** End-of-the-Rope Prusik. This knot is always secured with a bowline. Do not tie this knot with tape due to less friction.

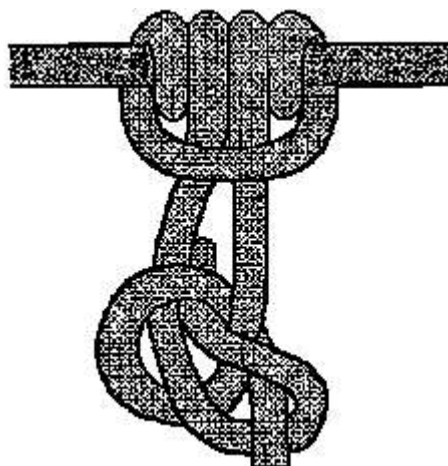

**END OF THE LINE PRUSIK**

**c)** French Prusik. This can be constructed with a Prusik Cord or a single strand of

cord with figure-of-eight loops on each end.

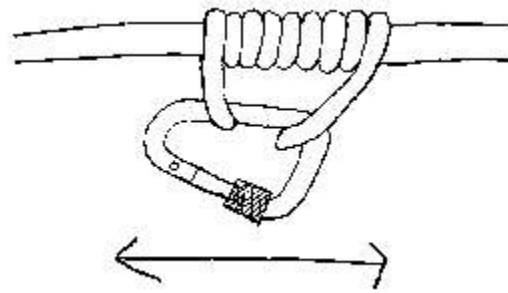

**FRENCH PRUSIK**

**2**) **Retraced Figure of Eight**. Used to tie the end of the climbing rope into a harness or swammi wrap. The pigtail may or may not be secured with an overhand.

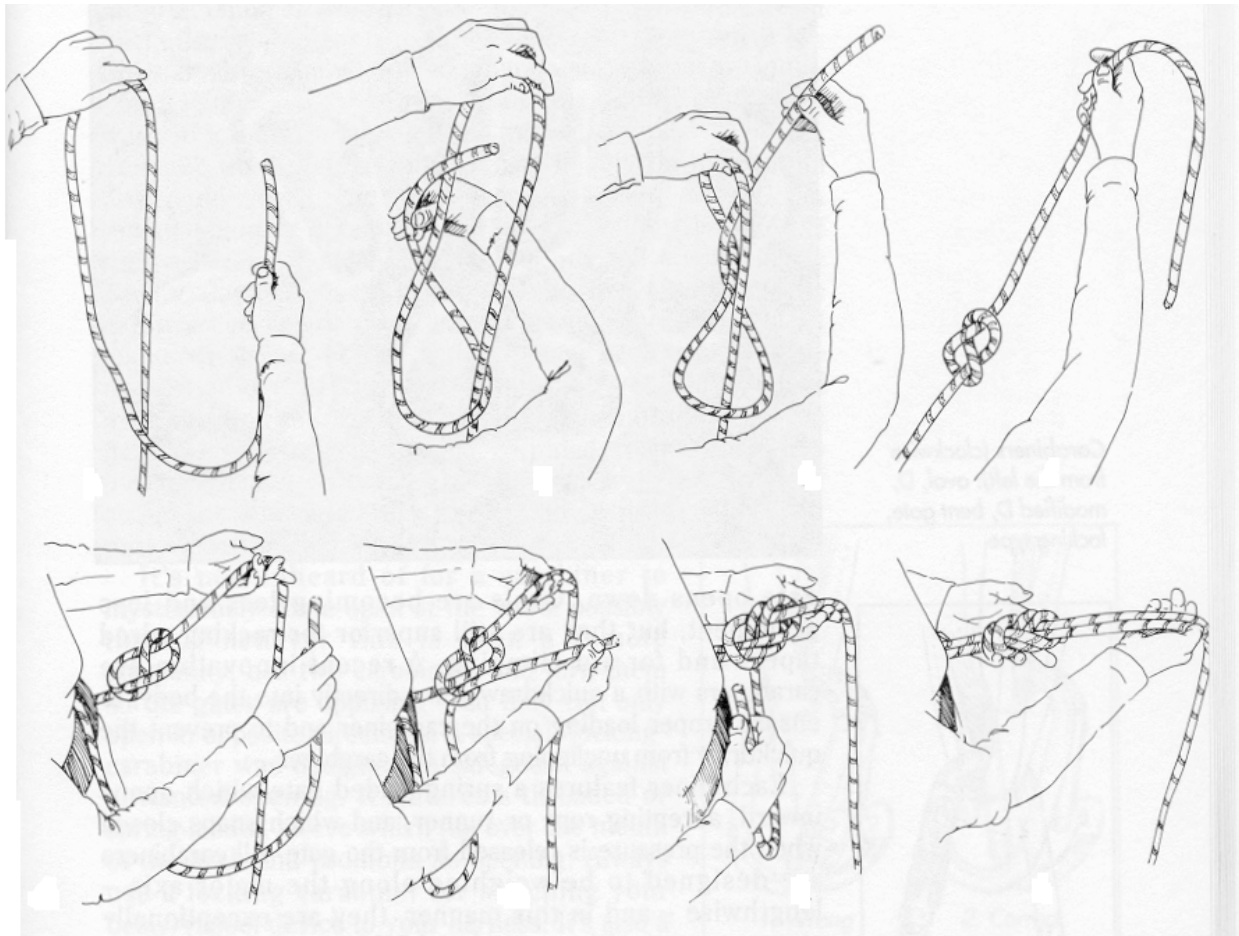

**RETRACED FIGURE 8 IN HARNESS**

**3**) **Directional Figure-Of-Eight**. When tied and tensioned is applied to the standing and running ends of the rope, the knot will not pull apart. The loop will point toward the direction of pull.

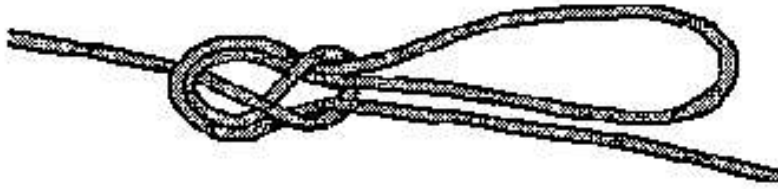

**DIRECTIONAL FIGURE 8**

- 4 ) Slip Figure 8. This knot is used for retrievable anchors and fixed rope installations for the ease of untying the knot.

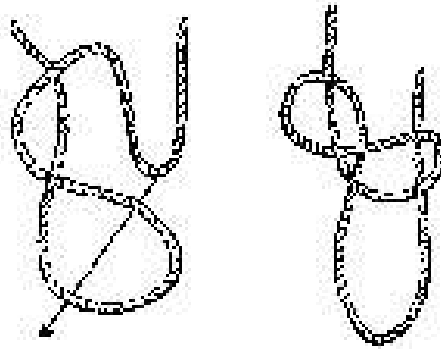

**SLIP FIGURE 8**

- 5 ) Kliemheist. This is a friction knot.

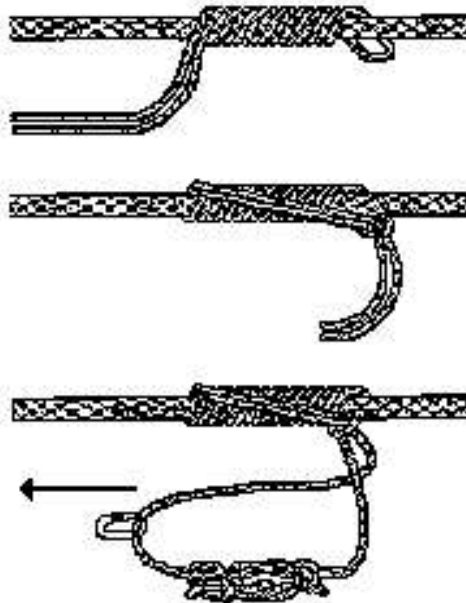

**KLEIMHEIST**

- 6 ) Overhand Knot. Can be used to secure primary knots on itself.

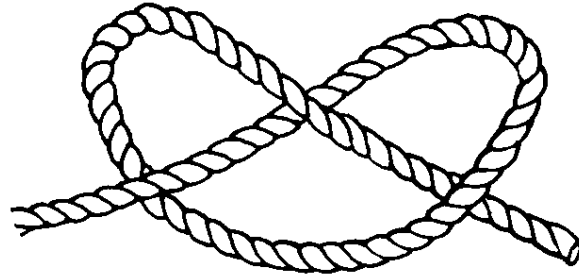

**OVERHAND**

**7**) **Münter Hitch**. This is a simple hitch in the rope that is clipped into a carabiner to put friction on the line.

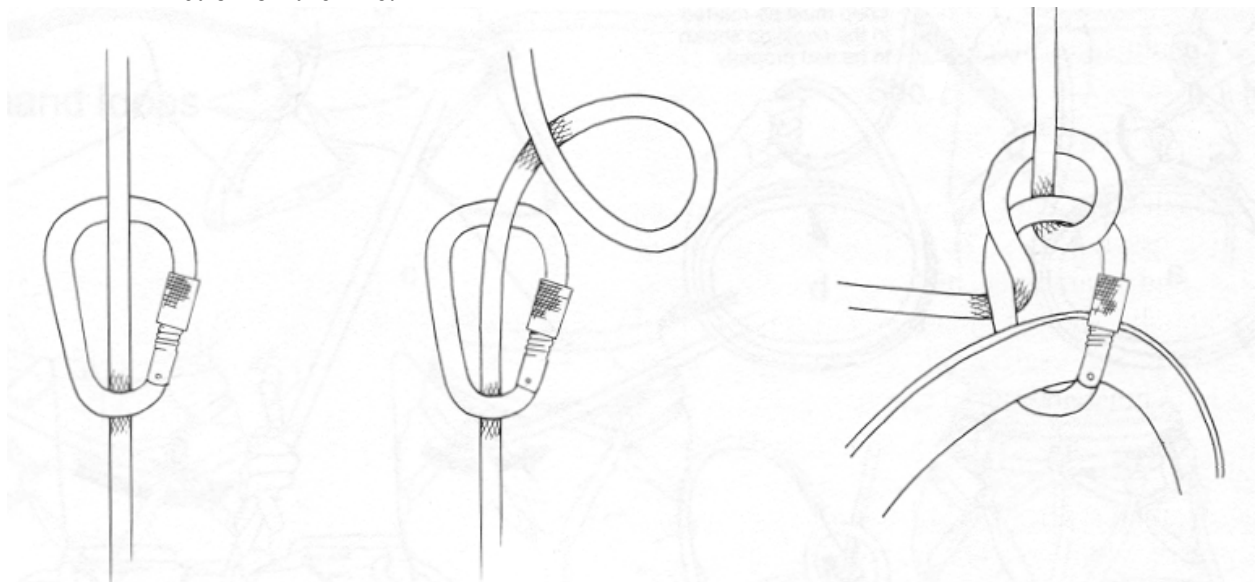

**MÜNTER HITCH**

**8**) **Timber Hitch**. A Timber Hitch is used to fix a rope to a pole or equivalent for hoisting or towing purposes. It has the capability of casting off easily.

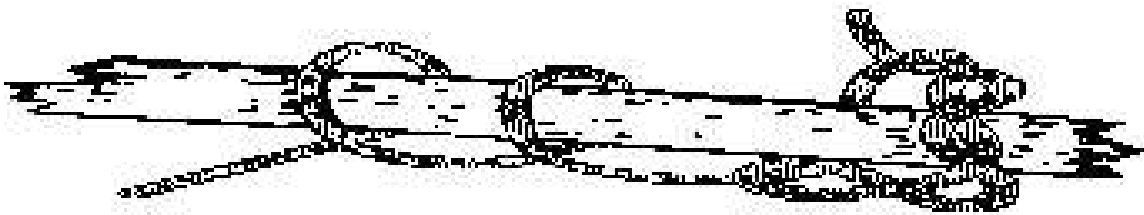

**TIMBER HITCH**

**9**) **Mariner's Hitch**. This knot's advantage over the prusik is that it can be released under load.

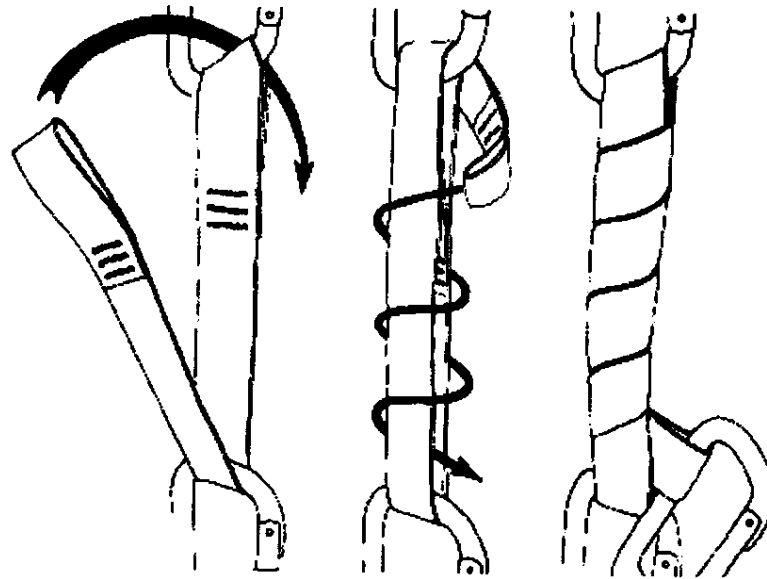

MARINER'S HITCH

10 ) Krägur Knot. This friction knot is used to prevent unnecessary slippage when tied onto a rope of the same diameter.



KRÄGUR KNOT

11 ) Rappel Seat. This is used as an expedient support harness for rappelling, crossing rope bridges, etc. It is constructed as follows:

a) Center the sling rope on the left hip.

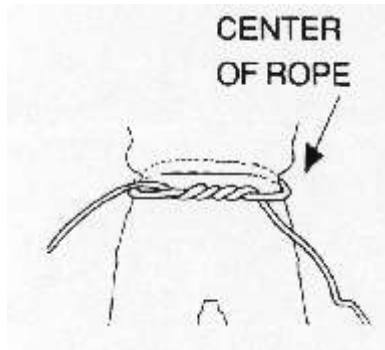

- b**) Wrap the sling rope around the waist and tie at least one half hitch around itself (preferably two) in the front.

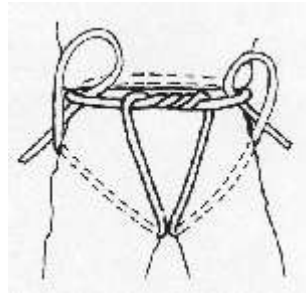

- c**) Bring the running ends down through the legs, up over the buttocks, and over the original waist wrap, down between the waist wrap and the waist, and over itself, forming a bight. Cinch this up tightly.

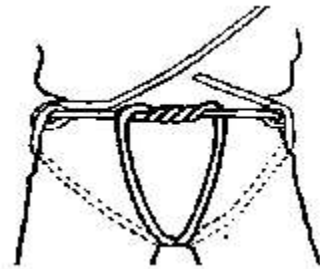

- d**) Now tie a square knot with two overhand knots on the left hip ensuring that the overhand knots encompass all the wraps.

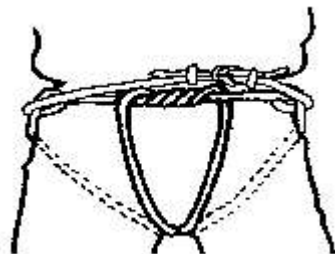

- e**) Tuck any excess rope into a pocket.

**12**) Bowline on a coil. Used by the first and last men on a climbing rope to tie into the

rope. An overhand knot is used behind the knot. It distributes the force of a fall over a larger area of a climber's waist and is preferable to a single bowline around the waist. The bowline on a coil can also be used to take up excess rope. The bowline on a coil should have 4-6 wraps around the waist.

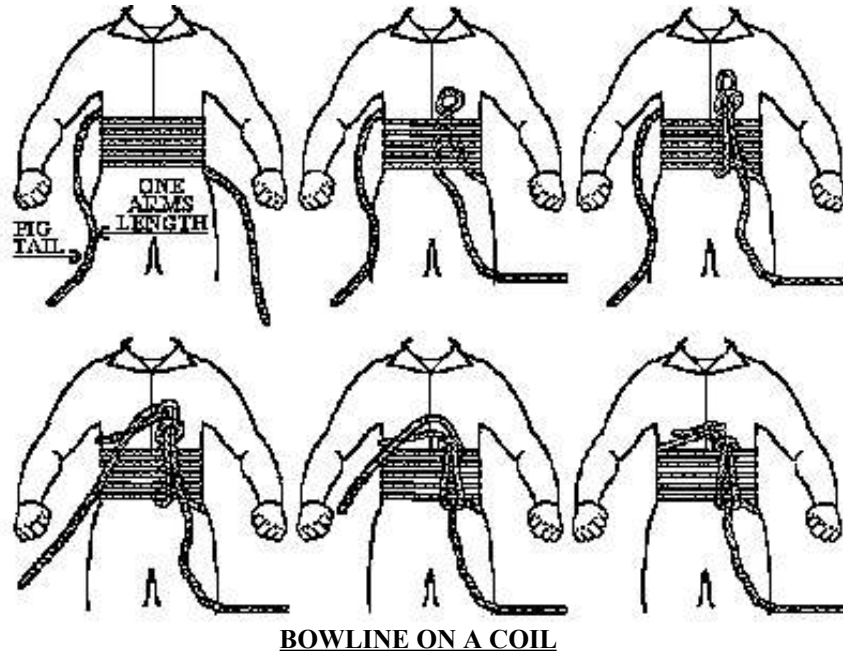

**13 )** Swami wrap (Swami belt). The swami wrap (four to six wraps of rope or nylon webbing tied around the waist) popular with rock climbers who wanted to increase the working length of their climbing ropes. It also offers some improvement over the bowline on the coil in distributing the forces sustained in a fall over a larger area of the midsection of the body, but does not eliminate the problem of suffocation when hanging. The Swami wrap is constructed as follows:

- a) Take a sling rope and find the middle.
- b) Place the middle of the sling rope in the small of your back.
- c) Bring both pigtails to the front and continue to wrap around your body until both pigtails are about 15-20 inches long.
- d) Tie the pigtails on the left side with a square knot and two overhand knots.



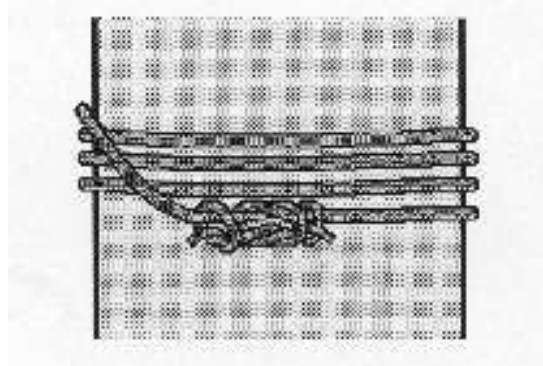

**SWAMMI WRAP**

**14 )** Three Loop Bowline. This knot will provide three bights, each of which can be adjusted against the others.

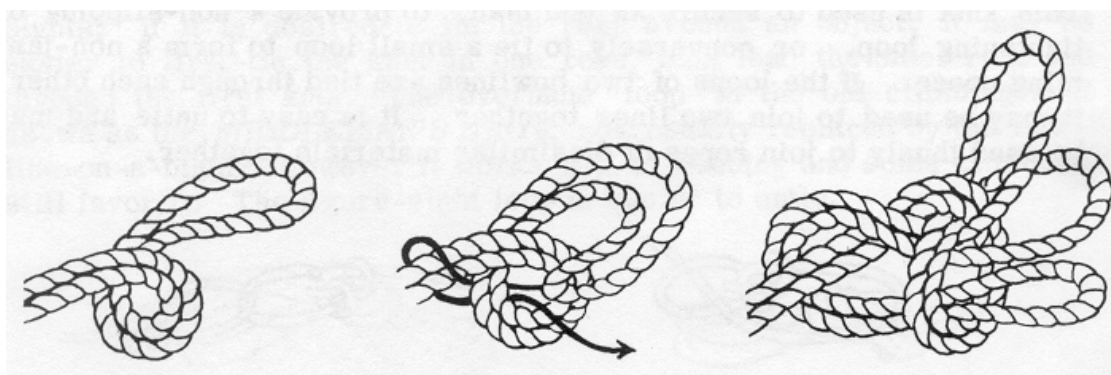

**THREE LOOP BOWLINE**

TRANSITION: Now that we have discussed the different types of knots and their classifications, let us now talk about the relative strength of the knots.

**7** (5 Min) **KNOT STRENGTH.** Rope, cordage and webbing is strongest when loaded in a straight line. When bending a rope or web to create a knot, the strength of the rope is reduced. All knots should be dressed properly for maximum effective use.

<b>KNOT</b>	<b>RELATIVE STRENGTH OF KNOT</b>
No Knot	100%
Figure 8	75-80%
Bowline	70-75%

Double Bowline	70-75%
Double Fisherman	65-70%
Water Tape Knot	60-70%
Clove Hitch	60-65%
Overhand Knot	60-65%
Square Knot	45%

TRANSITION: Now that we have discussed the relative strength of knots, let's discuss the criteria of the knot test.

**8.** (5 Min) **KNOT TESTING TIME LIMIT.** The following times must be met to pass the knot tying portion of this course.

<b><u>KNOT</u></b>	<b><u>UNIT OPERATIONS TIME LIMIT</u></b>	<b><u>SML, ACC TIME LIMIT (BLINDFOLDED)</u></b>
Square knot	60 Seconds	30 Seconds
Double Fisherman's Knot	60 Seconds	30 Seconds
Water/Tape Knot	60 Seconds	30 Seconds
Round Turn and a Bowline	60 Seconds	30 Seconds
Round Turn and Two Half Hitches	60 Seconds	30 Seconds
Clove Hitch (around the object)	60 Seconds	30 Seconds
Munter Hitch	60 Seconds	30 Seconds
Slip Figure 8	60 Seconds	30 Seconds
Figure 8 Loop	60 Seconds	30 Seconds
Directional Figure 8	60 Seconds	30 Seconds
End of the Line Prusik	90 Seconds	45 Seconds
Retrace Figure 8	90 Seconds	45 Seconds
Rappel (Swiss) Seat	2 Minutes	60 Seconds

**INSTRUCTOR NOTE:** Explain the knot, demonstrate, and then have the students tie the knot. Instruct the students not to clear the knot until they have been checked by an instructor.

TRANSITION: Now that we have discussed rope terminology, considerations for care and maintenance, coiling of the ropes, mountaineering knots and their strengths are there any questions? If you have none for me, then I have some for you.

**PRACTICE**

(CONC)

- a.** Students will practice proper rope management.

**PROVIDE HELP**

(CONC)

- a. The instructors will assist the students when necessary.

**OPPORTUNITY FOR QUESTIONS**

(3 Min)

**1. QUESTIONS FROM THE CLASS**

**2. QUESTIONS TO THE CLASS**

- Q. What are the two types of rope coils and in what situation is each used?

A. (1) Mountain Coil - used in movement from point to point when frequent use of the rope is anticipated.

2 ) Butterfly Coil - used when you have to carry the rope and require maximum freedom of movement of your arms.

**SUMMARY**

(2 Min)

- a. During this period of instruction we have discussed the various considerations of rope management, including the mountaineering knots that you will be using.
- b. Those of you with IRF's please fill them out at this time and turn them in to the instructor. We will now take a short break and then you will be guided to your next class by one of your company instructors.

**UNITED STATES MARINE CORPS**  
Mountain Warfare Training Center  
Bridgeport, California 93517-5001

SML  
SMO  
ACC  
02/11/02

**LESSON PLAN**

**MOUNTAIN CASUALTY EVACUATIONS (SUMMER)**

**INTRODUCTION**

(5 Min)

1. **GAIN ATTENTION.** Harsh terrain and adverse weather conditions are inherent to a mountainous environment. Under these conditions personnel with relatively minor injuries can become casualties which require evacuation. By using the techniques and equipment outlined here, these casualties can be evacuated safely and efficiently.
2. **OVERVIEW.** The purpose of this period of instruction is to introduce the student to the techniques used in evacuating casualties in a mountainous environment. This will be accomplished by discussing the general considerations, one and two man carries, expedient litters, regular litters, pre-rigging litters, and cliff evacuations. This lesson relates to conducting a cliff assault. (SMO & ACC)

**INSTRUCTOR NOTE:** Have students read learning objectives.

3. **INTRODUCE LEARNING OBJECTIVES**

- a. **TERMINAL LEARNING OBJECTIVES.** In a summer mountainous environment and given a simulated/actual casualty, evacuate casualties, in accordance with the references.
- b. **ENABLING LEARNING OBJECTIVES.** (SML) and (ACC)
  - (1) Without the aid of references, list in writing the general considerations for Casevac procedures, in accordance with the references.
  - (2) Without the aid of references, construct an expedient litter, in accordance with the references.
  - (3) **SQUAD:** In a summer mountainous environment, and without the aid of references, secure a simulated/actual casualty in a SKED litter, in accordance with the references.
  - (4) **SQUAD:** In a summer mountainous environment, and without the aid of references,

attach a belay line to a SKED litter for movement up/down moderate slopes, in accordance with the references.

(5) Without the aid of references, list in writing the site selection considerations for lowering a victim, in accordance with the references.

(6) SQUAD: In a summer mountainous environment, without the aid of references, and given a simulated/actual casualty, conduct a CASEVAC using the barrow-boy method, in accordance with the references.

c. ENABLING LEARNING OBJECTIVES (SMO)

(1) With the aid of references, state orally the general considerations for Casevac procedures, in accordance with the references.

(2) In a summer mountainous environment, and with the aid of references, construct an expedient litter, in accordance with the references.

(3) SQUAD: In a summer mountainous environment, and with the aid of references, secure a simulated/actual casualty in a SKED litter, in accordance with the references.

(4) SQUAD: In a summer mountainous environment, and with the aid of references, attach a belay line to a SKED litter for movement up/down moderate slopes, in accordance with the references.

(5) With the aid of references, state orally the site selection considerations for lowering a victim in accordance with the references.

(6) SQUAD: In a summer mountainous environment, with the aid of references, and given a simulated/actual casualty, conduct a CASEVAC using the barrow-boy method, in accordance with the references.

4. METHOD/MEDIA. The material in this lesson will be presented by lecture and demonstration method. You will practice what you have learned in upcoming field training exercises. Those of you with IRF's please fill them out at the end of this period of instruction.

5. EVALUATION

a. SML - You will be tested later in the course by written and performance evaluations on this period of instruction.

b. SMO - You will be evaluated by an oral exam and a performance exam on T- 11.

TRANSITION: Are there any questions over the purpose, learning objectives, how the class will be taught, or how you will be evaluated? Any disabled Marine requiring Casevac must be treated with basic first aid, along with considerations in conducting the actual evacuation properly.

## **BODY**

(60 Min)

1. (5 Min) **GENERAL CONSIDERATIONS** The general considerations are a set of guidelines that can be used no matter how serious the casualty is. They are remembered by a simple acronym, **A PASS NGG**.
  - a. **Apply Essential First Aid**. (i.e. splints, pressure bandage, etc.)
  - b. **Protect the Patient from the Elements**. Provide the casualty with proper insulation from the ground. Ensure that he is warm and dry. If there are any natural hazards (i.e. rock fall, lighting, etc.) either move the casualty as quickly as possible or ensure that he is well protected.
  - c. **Avoid Unnecessary Handling of Patient**.
  - d. **Select Easiest Route**. Send scouts ahead if possible, to break trails.
  - e. **Set Up Relay Points and Warming Station**. If the route is long and arduous, set up relay points and warming stations with minimum amount of medical personnel at warming stations to:
    - (1) Permit emergency treatment. Treat for shock, hemorrhage, or other conditions that may arise.
    - (2) Reevaluate the patient constantly. If patient develops increased signs of shock or other symptoms during the evacuation, he may be retained at an emergency station until stable.
  - f. **Normal Litter Teams Must Be Augmented in Arduous Terrain**.
  - g. **Give Litter Teams Specific Goals**. This litter teams job is extremely tiring, both physically and mentally. The litter teams must be given realistic goals to work towards.
  - h. **Gear**. Ensure all of the patient's gear is kept with him throughout the evacuation.

**TRANSITION**: Now that we have covered the considerations, are there any questions? The basic carries that are taught in the EST manual (fireman's carry, two-hand, four-hand, and the poncho litters) are still viable of transporting an injured man; however, we need to know a few more that can aid us during a medevac.

2. (10 Min) **EXPEDIENT LITTERS**. There are five types of expedient litters that we will talk about. They are the sling rope carry, rope coil carry, pole carry, the alpine basket and the poncho litter.
  - a. **Sling Rope Carry**. The sling rope carry requires two men and a 15-foot sling rope. One as the bearer, and an assistant to help in securing the casualty to the bearer. Conscious or

unconscious casualties may be transported in this manner:

(1) Bearer kneels on all fours and the assistant places casualty face down on bearer's back ensuring the casualty's armpits are even with the bearer's shoulders.

(2) He then finds the middle of the sling rope and places it between the casualty's shoulders and the ends of the sling rope are run under the casualty's armpits, crossed and over the bearer's shoulders and under his arms.

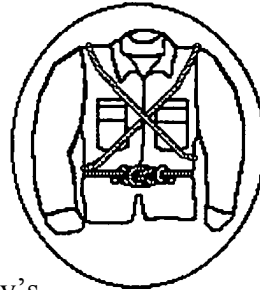

(3) Then the ropes are run between the casualty's legs, around his thighs, and tied with a square knot with two overhands just above the bearer's belt buckle.

(4) Ensure the rope is tight. Padding, when available, should be placed where the rope passes over the bearer's shoulders and under the casualty's thighs.

**SLING ROPE CARRY**

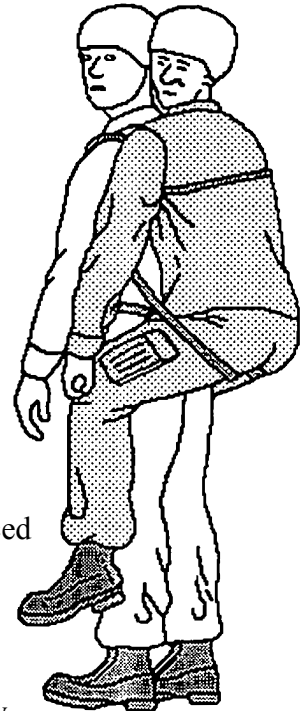

b. The Rope Coil Carry. This requires a bearer and a rope coil. It can be used to carry a conscious or unconscious casualty.

(1) Position the casualty on his back.

(2) Separate the loops of the mountain coil into two approximately equal groups.

(3) Slip  $\frac{1}{2}$  of the coil over the casualty's left leg and  $\frac{1}{2}$  over his right leg so that the wraps holding the coil are in the casualty's crotch, the loops extending upward the armpits.

(4) The bearer lies on his back between the casualty's leg and slips his arms through the loops. He then moves forward until the coil is extended. When using the rope coil the bearer ties the coil to himself vice slipping his arms through the loops.

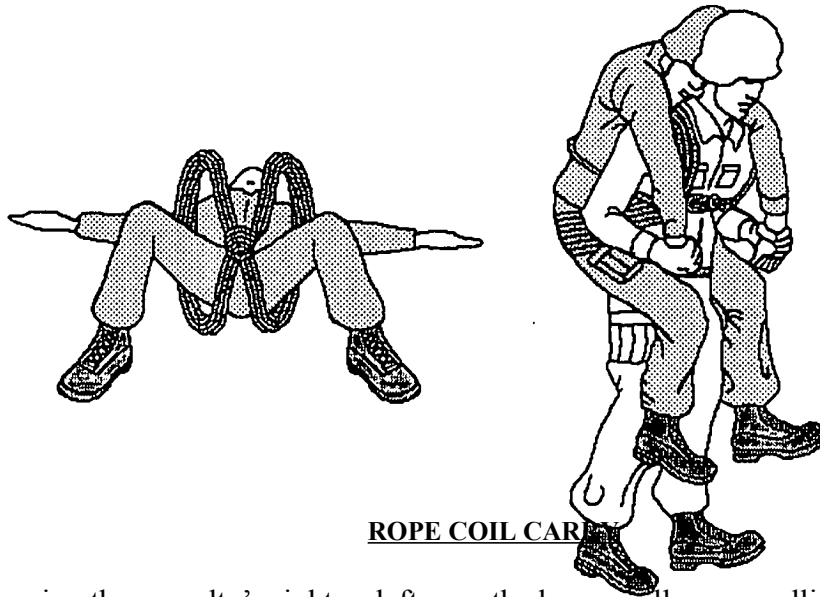

ROPE COIL CARRY

- (5) Grasping the casualty's right or left arm, the bearer rolls over, rolling to the casualty's uninjured side, pulling casualty onto the bearer's back.
- (6) Holding the casualty's wrists, the bearer carefully stands, using his legs to lift up and keeping his back as straight as possible.

**NOTE:** The length of the coils on the rope coil and the height of the bearer are to be considered. If the coils are too long and the bearer happens to be a shorter person, it will require the coils to be uncoiled and shortened. If this is not done, then the casualty will hang too low on the bearer's back and make it a very cumbersome evacuation. A sling rope harness can be used around the victim's back and the bearer's chest, which will free the bearer's hands.

- c. Pole Carry. The pole carry method is a field expedient method and should be considered as a last resort only, when narrow ledges must be traversed; vegetation limits the bearers to a narrow trail. This method is difficult for the bearers and uncomfortable for the casualty. Two bearers, four sling ropes and a 12 foot pole - 3 inches in diameter, are required for this carry.
  - (1) The casualty is placed on his back in a sleeping bag or wrapped in a poncho or blanket, then placed on an insulated pad.
  - (2) One sling rope is placed under the casualty below the armpits and tied with a square knot across the casualty's chest.
  - (3) The second sling rope is tied in the same manner at the casualty's waist.
  - (4) The third sling rope is placed at the casualty's legs below the knee.
  - (5) The fourth sling rope is tied around the ankles.



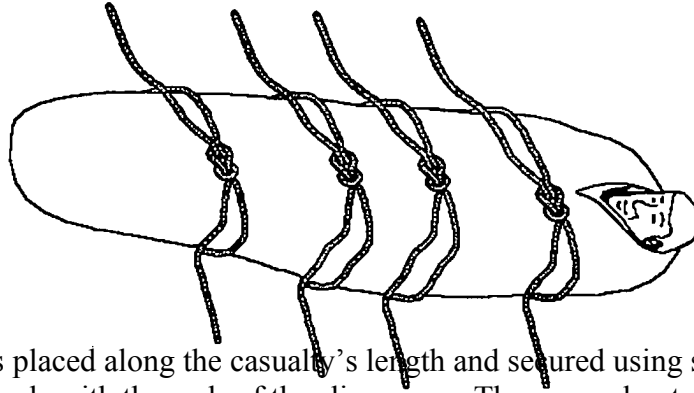

- (6) The pole is placed along the casualty's length and secured using square knots with two overhands with the ends of the sling ropes. The square knots should be so tight that the overhands are tied onto themselves

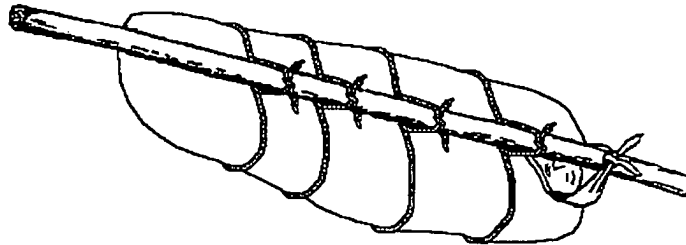

- (7) The casualty should hang below the pole, as close to the pole as possible, to prevent swinging during movement.
- (8) The casualty's head may be supported using a triangular bandage or a cartridge belt passed around the pole.
- (9) For additional support and of movement, two additional bearers may be required, as well as a mountain coil.
- (a) Mountain coil is split into two equal coils.
  - (b) Place knot of mountain coil under casualty's lower back.
  - (c) Additional bearers slip into each half of the hasty coil one on each side of casualty, aiding in support and movement of the casualty.
- d. Alpine Basket. To belay the alpine basket, the pre-rigs are attached to the bights formed coming through the loops.
- (1) If barrow boy is to be used, the procedure previously discussed will be adhered to.
  - (2) If barrow boy is not used, then a tag line from the bottom must be implemented to keep the casualty away from the cliff face on the decent.
  - (3) Construction of the Alpine Basket:

(a) Start by making the same amount of bights as in the rope litter, but start from one end and tie a figure-of-eight loop to run the first bight through.

(b) Place padding i.e., isopor mat, on top of the bights and then lay the casualty on the padding and bights.

(c) Start at the casualty's feet and pull the first bight up around the casualty's ankles and through the figure-of-eight loop tied into the starting end of the rope.

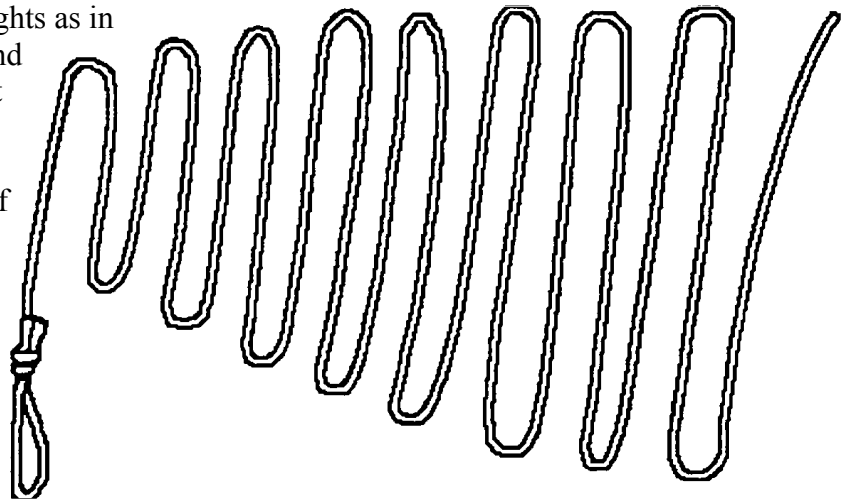

(d) Go to the opposite side of the casualty and pull up the second bight and pull it through the loop formed by the bight that was pulled through the figure-of-eight.

(e) Continue until you get to the casualty's armpits, bring the second to the last bight up over the casualty's shoulder and into the bight and then bring the last bight up over the casualty's other shoulder and into the last bight formed.

(f) Secure the last bight with a round turn and two half hitches leaving a big enough bight to tie a figure eight at the end.

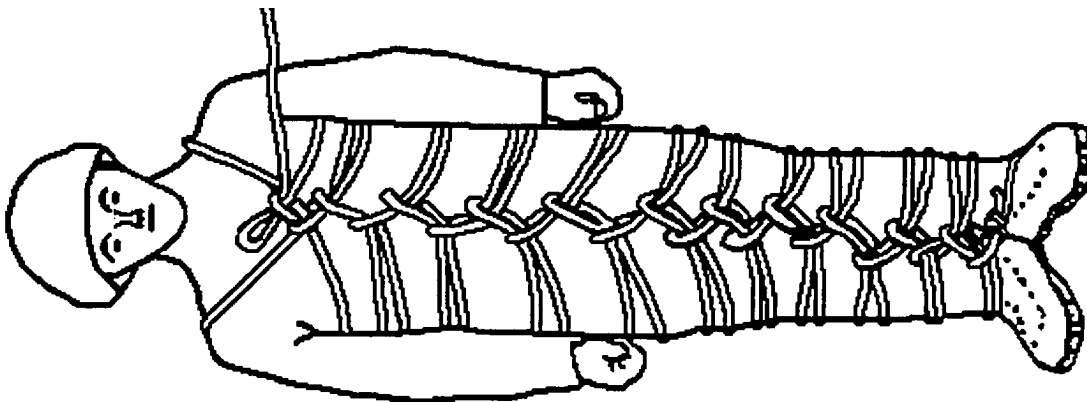

#### THE ALPINE BASKET

e. Poncho Litter. A poncho, poncho liner, bivy bag or similar piece of material may be used. In addition you will need six individuals with sling ropes.

- (1) Lay poncho litter flat on the ground.
- (2) Select six rocks about the size of a golf ball. Place one rock in each of the corners and one in the middle on each side in the middle of the litter. The rocks are placed on the under side of the poncho or like material. If a bivy bag is used the casualty should be zipped inside the bivy bag. The rocks should then be arranged in the same manner only on the inside below the zipper.
- (3) Tie the sling rope together with an overhand knot. Take the middle of the rope and secure it around the rock with a clove hitch.
- (4) An isomat may be laid on the poncho to help make the litter firmer.
- (5) The casualty is then placed in the litter. The sling ropes are adjusted by feeding the pigtails of the over hand knot through itself to adjust for length. The loop is then put over the inboard shoulder of the carriers. Insure that the casualty is carried level.

TRANSITION: Are there any questions over the expedient litters? For casualties with more serious injuries, or casualties that may occur in moderate to vertical terrain a more ridged litter may need to be employed.

3. (10 Min) **LITTERS.** There are two kinds of litters that are used for casualty evacuations in moderate to vertical terrain. The SKED litter and the Stokes litter. Each has a variation of procedures for securing a casualty and rigging the litters for either raising or lowering. Let's first look at the SKED litter.

a. SKED Litter. The SKED litter is constructed of thin foam padding, straps and grommets.

(1) Securing a Casualty to the SKED

- (a) First unroll the litter. The litter must be re-rolled the opposite way to allow the litter to lay flat. Then lay the litter next to the casualty.
- (b) If the casualty has any possibility of a spinal injury the Oregon Spine Splint must be used. Secure the splint to the casualty by use of the color-coded buckles. Experienced medical personal are recommended if spinal immobilization is necessary.
- (c) Once the casualty is on the SKED use the four body straps to secure the casualty to the litter. Unless injuries prevent, the casualty's arms should be at his sides to prevent further injuries to himself or the rescuers.
- (d) Once the casualty is secured with the body straps the feet straps must be secured. The feet straps are secured last to ensure the casualty is in the proper position on the SKED. The feet can be positioned in three ways. The first position is feet together with the straps running on the outside of the feet. The second position is feet apart with the straps running on the inside of the feet. The last position is the feet stacked. This is the most uncomfortable position and not recommended for

casualties with possible spinal cord injuries. This position is formed by placing the heel of one foot on top of the toes of the other. This position will only be used for a casualty in confined spaces. Once the feet are positioned the feet straps must be secured. Start by bending the feet end of the SKED to form a platform for the feet. Then loop the feet straps through the second grommets on each side.

- (e) The last thing to do is to form the head end to protect the casualty's head. If possible the casualty should wear a helmet. Form the head end tying the pull strap up and secure it to the first body straps.
- (2) Casevacating a Casualty. There are many ways to move a casualty once in the SKED. However the medevac team must keep the general considerations in mind. The two methods that we will talk about next are the simplest and require the least amount of additional rigging
- (a) The first way is to drag the casualty by the drag strap located at the head end of the SKED. You can also use the SKED's carrying bag as a harness in conjunction with the pull strap and towing harness. If additional people are required, cordage can be added to the pull strap or the front carrying handles.
  - (b) The second way is to carry the casualty using the carrying handles. By using the set of four removable webbing the litter team can be augmented. To do this each piece of webbing is tied to make an endless loop. Then pass a bight of the loop through one of the grommets to create additional handles.
- (3) Rigging the SKED for Vertical Terrain and Helicopter Lift. In this type of terrain special requirements must be taken to raise or lower a casualty in the SKED.
- (a) Rigging the SKED for a Vertical Employment. A vertical raise or lower is used when moving a casualty on steep earth to avoid any further injury to the casualty. On vertical terrain the vertical raise or lower can be used if the terrain is not uniform or there is a chance of rock fall. Ensure that the casualty's head is always above his feet.
    1. Identify the 30-foot piece of cordage that comes with the SKED. Then tie a figure eight in the middle of the rope. If the rope is worn or missing, the same process can be done with two sling ropes.
    2. Next pass each end of the rope through the grommets at the head of the SKED. Leaving approximately 1-2 feet of rope between the stretcher and the knot.
    3. Continue to feed each end through the grommets and the carrying handles towards the foot end of the SKED. Pass the ends of the rope through the last grommets at the foot end and secure the two ends with a square knot without over hands.

4. Bring the pigtails up and over the casualty's feet and pass the ends through the
  - a carrying handles towards the middle of the casualty. Then tie a square knot
  - b with two over hands.

c

- (4) Rigging the SKED for a Horizontal Employment. A horizontal raise or lower is preferred on uniformed vertical terrain. The horizontal employment allows the rescuer to assist the casualty on either a raise or lower. It also allows the rescuer the ability to monitor the casualty's condition and can easily treat the casualty if the need arises.

- (a) Identify the two 4 inch nylon straps. They should be two lengths; one four inches shorter than the other. The shorter strap should be marked HEAD STRAPS.
- (b) Insert one end of the head strap into a slot near the head of the litter. Then wrap the rest of the straps under the SKED and pass the other end through the opposing slot. Do the same at the foot end of the SKED with the other strap. Ensure that the strap runs smoothly under the SKED.
- (c) Connect the strap ends with the large locking carabiner that comes with the SKED. If the carabiner is worn or missing, opposing stubai 85 locking carabiners will suffice.

- b. Stokes Litter. The stokes litter is a litter that is constructed of metal tubing with a plastic covering. The litter is formed in a rectangular basket shape with mesh attached to the frame. Using the stokes for an evacuation (as with any evacuation) it should be padded for the casualty.

- (1) Securing the casualty to the stokes litter. In the event that the "seat belts" are missing from the stokes litter, sling ropes can be used to the lash the casualty. The steps involved are:

- (a) Tie two sling ropes together using square knots and two overhands.
- (b) Tie a stirrup hitch around ankles and feet, feed the two pigtails through the right angles of the stokes. Do not cross the ropes at the ankles.
- (c) Lace the sling rope towards the casualty's head by passing the rope through the right angles (not over the top of the rails of the stokes).
- (d) Secure the ends of the sling ropes by tying a clove hitch with two half hitches on the thick vertical bar located by the victim's shoulder.

TRANSITION: Know that we have talked about the two different litters, let us now discuss how to attach a belay line to the litter.

6. (5 Min) **YOSEMITE PRE-RIG.** The title of this method, pre-rig implies the meaning ready to use, but in this case the rig must be constructed. Its purpose is for attaching a belay

line to a litter and to make the litter easily adjusted. This is the one method that is used to secure a litter to a belay line.

- a. Construction. This method normally requires four sling ropes. The steps are: (1) Using one sling rope, tie a figure-of-eight loop with one tail.
  - (1) Take the remaining tail and run it through the window of the stokes litter or in the stirrups of the collapsible litter.
  - (2) Tie a kragur knot onto the same sling rope.
  - (3) Repeat steps (1), (2), and (3) with the three remaining sling ropes.
  - (4) Suspend the litter to ensure that the comers are balanced.

TRANSITION: Now, let's cover the ways to make descents and the belaying methods.

7. (10 Min) **ASCENTS OR DESCENT OVER STEEP TO MODERATE SLOPES**. When the litter team is ascending or descending a slope they must consider the potential for further injury to the casualty or to themselves. If the risk of injury is high a belay line may be used to prevent injury to the casualty and the rescuers.
  - a. Preparing Casualty for Ascents or Decent over Steep to Moderate Terrain. This procedure will be depending on several things. Initially, site selection should contain the following features.
    - (1) Suitable anchor points.
    - (2) Clearance for casualty along the route
    - (3) Loading and unloading points.
  - b. Additional considerations.
    - (1) The casualty will always be rigged for vertical employment when on steep to moderate terrain.
    - (2) The smoothest possible route must be selected.
    - (3) Ensure that the casualty's head is above his feet.
  - c. Rescuers positions. There are two methods that can be used for the rescuers for moving a casualty in steep to moderate terrain.
    - (1) Two to four men will position themselves on each side of the litter. They can then carry the litter by the carrying handles. In steep terrain a second belay line may be used to assist the rescuers. We will discuss the belay line later in the chapter.

- (2) The Caterpillar method will require as many personnel as possible. The personnel will split in half and position themselves on each side of the litter forming a tunnel. As the litter is raised or lowered each member will hand the litter to the next member in the tunnel. As the litter passes each person in the tunnel he will peel off and assume the lead either at the top or bottom of the tunnel. This will continue until the litter reaches its desired destination.
- d. Belay Line. For belaying of a casualty, one rope will be used and from the top using one of two methods depending on the application.
- (1) Body Belay. This method should only be used over moderate terrain. The belay man will establish a sitting position behind a suitable anchor (i.e., rock, tree, etc.) and pass the standing end of the rope behind his back. The running end of the rope will feed out from the belay man's right side. A figure of eight loop is tied to the end of the running end of the rope. It is then attached to the litter's figure eight loop with a locking carabiner. The belay man will then remove all of the slack between himself and the litter. The standing end of the rope should be stacked on the belay man's left side and run through his left side. As the casualty is lowered, the belay man will feed the rope from behind his back allowing it to run through his right hand. If the belay man needs to stop the casualty, he will clench the rope in his left hand, and bring the rope to the center of his chest.
- (2) Direct Belay. This method is the safest for either raising or lowering a casualty in either moderate to steep terrain.
- (a) To Lower a Casualty. First a swami wrap will be tied around a suitable anchor point. Two locking carabiners will be clipped into all of the wraps of the swami wraps, gates up. A figure of eight loop is tied into the end of the static rope and attached to the litter with a locking carabiner. After all the slack has been taken up between the litter and the anchor, the rope must be tied through an appropriate belay device. The belay device is attached to the anchor through one of the two locking carabiners on the anchor. A safety (French) prussic will be tied to the running end of the rope and clipped into the second locking carabiner on the anchor. While the casualty is being lowered, one person will control the rope running through the belay device. The safety prussic will be controlled by a second person. Should the primary belay man lose control, the person operating the safety prussic simply lets go and the prussic will bind onto the rope, stopping the casualty.
- (b) To Raise a Casualty. The anchors will be established in the same manner as discussed in lowering the casualty with one minor change. The one change is that instead of running the rope through a belay device, the rope will only run through a locking carabiner. The load will be raised by the use of a mule team. The mule must consist of as many people as possible. The mule team will raise the load in as straight a line from the anchor as possible. If the space does not permit a ninety-degree angle away from the anchor is also an option. The mule

team will walk backward until the last man reaches his limit of advance. Once he reaches that limit he will peel off the end and return to the front of the mule team. This process is continued until the casualty reaches the top. If the load becomes unmanageable, the safety prussic will be allowed to bind on the rope while the mule team repositions themselves. If the person operating the safety prussic can not see the casualty a Point NCO will be in charge of communicating with the mule team.

- (c) To Belay the Rescuers. If the route is too steep or the footing is poor the rescuers may need some assistance either on the raising or lowering of a casualty. If this is the case a separate belay line will be established for the rescuers. The anchor and the belay line are established in the same manner. The same anchor can be used if it is suitable for the load. The rescuers will then tie either around the chest bowlines or swami wraps. A figure eight loop will be tied into the end of the static rope and connected to the bottom rescuer with a locking carabiner. The other rescuers will connect themselves to the same rope with middle of the line prussic. They will be connected in this manner so that they can adjust their position to the casualty.

- 8. (7 Min) **BARROW BOY.** A barrow boy is no more than an assistant to the litter on vertical to near vertical cliff faces. The barrow boy can be used for either the Stokes or the SKED litters. For this situation the Stokes litter should only be used in the horizontal position. However the SKED can be employed in either the horizontal or the vertical positions.

**NOTE:** For safety purpose at MWTC, two ropes will be utilized.

- a. Rigging the Barrow Boy.

- (1) First the rescuer must ensure that a suitable anchor has been established, a proper belay has been constructed, and that a safety prussic has been constructed.
- (2) Then the rescuer must ensure that if an A-frame is used that it has been constructed and anchored properly.
- (3) Next the rescuer will tie a rappel seat on. ( a sit harness can also be used ) Then he will ensure that an around the body bowline is tied onto the casualty. A figure eight will be tied on to the end to act as the casualty's safety.
- (4) Then after running the running end of the rope through the carabiners or pulley of the A-frame he will tie a figure eight loop at the end of the static rope. He will then attach the figure eight loop to his hard point with a locking carabiner. Then he will tie a middle of the line prussic above the figure eight and attach it to the same locking carabiner in his hard point. This is called the adjustment prussic. It is used to adjust the position of the Barrow Boy in relation to the litter. Next he will take six to eight feet of slack from the end of the line figure eight and tie a directional figure of eight with direction of pull down. (Note: the prussic should be between the end of the line figure of eight and the directional figure of eight.) The directional figure of eight is



the attaching point for the litter and the casualty's safety.

- (5) Once the rescuer and the litter are secured, the belay man must take all the slack out of the system. The rescuers will maneuver the litter through the apex of the A-frame with the help of the point NCO.
  - (6) Once onto the cliff face the rescuer will then position himself with his adjustment prussic so that he can be of most assistance to the litter on the raise or lower. The rescuer will pull the litter out away from the cliff face so that the casualty rides smoothly up or down the cliff face.
  - (7) The Point NCO will be in charge of the belay men or the mule team. He will also communicate with the rescuer about the rate of speed, if the rescuer needs to be stopped along the route, and when he reaches the top or bottom of the cliff.
9. (5 Min) **TANDEM LOWERING.** The tandem lowering system can be used for the walking wounded, POW's, or more serious casualties when situation would not permit using the barrow boy.

**NOTE:** For safety purposes at MWTC, two ropes will be utilized.

- a. The assistant to the casualty should first tie a rappel seat on himself and then assist the casualty with his.
  - b. The assistant will take two belay lines and tie a end of the line figure 8 loop, and clip this into his rappel seat.
  - c. A directional figure 8 will be tied approximately 12 inches up the rope from the figure 8 loop (with the loop pointed down) and this will be clipped to the casualty's rappel seat.
  - d. If needed, adjustment prussic cords should be tied above the casualty's directional figure 8. These adjustment cords should be attached in the same manner as the first man down a rappel.
  - e. The casualty and the assistant will lower as one, with the assistant helping on the way down the cliff.
10. (3 Min) **OTHER CONSIDERATIONS.** All of the techniques we have discussed for the evacuation of a casualty from top to bottom can also be used on a suspension traverse or rope bridge, with a slight variation in the belay line. Two belay lines may be used for rope bridges and the suspension traverse, if they are available. No matter what type of litter is used, the individuals involved in the evacuation must ensure that the head is always uphill or not lower than the feet.

**TRANSITION:** What we have just covered are other considerations for Casevac, are there any questions.

**PRACTICE** (CONC)

- a. Students will evacuate a simulated/actual casualty.

**PROVIDE HELP** (CONC)

- a. The instructors will assist the students when necessary.

**OPPORTUNITY FOR QUESTIONS** (3 Min)

1. QUESTIONS FROM THE CLASS

2. QUESTIONS TO THE CLASS

Q. What are the eight considerations when conducting a mountain casualty evacuation?

- A. (1) Apply essential first aid.
- (2) Protect the patient from the elements.
- (3) Avoid unnecessary handling of patient.
- (4) Select easiest route.
- (5) Set up relay points and warming stations.
- (6) Normal litter teams specific goals to work towards.
- (7) Give litter teams specific goals to work towards.
- (8) Keep gear with casualty.

Q. What are the four site selections for lowering a CASEVAC victim?

- A. (1) Suitable anchor points.
- (2) Suitable Loading and unloading platforms.
- (3) Clearance for casualty along the route.
- (4) Anchor points for A-Frame, if used.

**SUMMARY** (2 Min)

- a. During this period of instruction we have covered some of the general considerations to include expedient litters, collapsible litters, stokes litter and the barrow-boy.
- b. Those of you with IRF's please fill them out at this time and turn them in to the instructor. We will now take a short break.

UNITED STATES MARINE CORPS  
Mountain Warfare Training Center  
Bridgeport, California 93517-5001

SML  
SMO  
ACC  
03/31/01

**LESSON PLAN**

**NATURAL AND ARTIFICIAL ANCHORS**

**INTRODUCTION**

(5 Min)

- 1. GAIN ATTENTION.** All military mountaineering activities that utilize ropes require that the ropes be anchored (secured) to something. If you wish to utilize a rope installation safely and in the correct manner, you must know what type of anchors are available for your use. At the conclusion of this period of instruction you will be able to identify and construct a suitable anchor.
- 2. OVERVIEW.** The purpose of this period of instruction is to introduce the students to the various methods used to anchor a rope to both natural and artificial devices. This lesson relates to all other lessons utilizing anchors.

**INSTRUCTOR NOTE:** Have the students read learning objectives.

**3. INTRODUCE LEARNING OBJECTIVES.**

**a. TERMINAL LEARNING OBJECTIVE.** In a summer mountainous environment, establish an anchor system in accordance with the references.

**b. ENABLING LEARNING OBJECTIVES.** (SML) and (ACC)

**1 )** Without the aid of references, list in writing the types of anchors, in accordance with the references.

**2 )** Without the aid of references, describe in writing how many pieces of protection are used for an artificial anchor when installing a two rope, high-tension system, in accordance with the references.

**3 )** Without the aid of references, describe in writing how many pieces of artificial protection are used in constructing a two-rope high-tension installation, in accordance with the references.

4 ) In a summer mountainous environment, establish a natural anchor point, in accordance with the references.

5 ) In a summer mountainous environment, establish an artificial anchor system, in accordance with references.

c. ENABLING LEARNING OBJECTIVES. (SMO).

1 ) With the aid of references, list orally the types of anchors, in accordance with the references.

2 ) With the aid of references, list orally how many pieces of protection are used for an artificial anchor when installing a two rope, high tension system, in accordance with the references.

3 ) With the aid of references, list orally how many pieces of protection are used for artificial anchors when installing a one rope, non-high tension system, in accordance with the references.

4 ) In a summer mountainous environment, establish a natural anchor point, in accordance with the references.

5 ) In a summer mountainous environment, establish an artificial anchor system, in accordance with references.

4. **METHOD/MEDIA.** The material in this lesson will be presented by lecture and demonstration. Those of you with IRF's please fill them out at the end of this period of instruction.

5. **EVALUATION.**

a. MLC - You will be tested later in the course by written and performance evaluations on this period of instruction.

b. ACC - You will be tested later in the course by written and performance evaluations on this period of instruction.

c. SMO - You will be evaluated by an oral and performance evaluation later on.

TRANSITION: Are there any questions on the learning objectives, how I will be presenting this period of instruction, or how and when you will be evaluated. Let's now discuss the two types of anchors.

## **BODY**

(45 Min)

1. (5 Min) **TYPES OF ANCHORS**. There are two types of anchors that we use. These two types are:

- a. Natural
- b. Artificial

**TRANSITION:** We will now take a look at considerations for anchors.

2. (5 Min) **GENERAL CONSIDERATIONS FOR ANCHORS**. Anytime you employ natural or artificial anchors; there are special considerations that you must apply. These considerations apply both to the anchor itself and to the material being used to build the anchor. Some examples of these considerations are:

- a. Whether using natural or artificial anchors, the installing unit must insure that the anchor is suitable for the load.
- b. The anchor position must be relative to the direction of pull on the anchor.
- c. The angle between the anchor points should not exceed 90 degrees. This is to ensure that no added stress is put upon the anchors, as well as the equipment being used to construct the anchor.

1 ) To decrease the angle between anchor points, materials (i.e. sling ropes, web runners, prusik cord, etc.) could be used to extend the anchor which will decrease the angle between anchor points.

**TRANSITION:** We have just talk about considerations for anchors. Are there any questions? Now we will talk about Natural Anchors.

3. (15 Min) **NATURAL ANCHORS**. A natural feature is the preferred type of anchor point. Some examples and considerations are as followed:

a. Types of natural anchors.

1 ) Trees.

- a) Select a tree that has not been chopped, burned or is rotten.
- b) The tree should be at least 6" in diameter and strong enough to support the intended load.
- c) Trees growing on rocky terrain should be treated with suspicion, since the roots normally are shallow and spread out along a relatively flat surface.

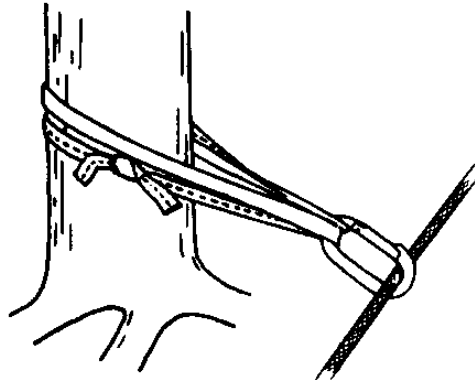

**RUNNER USED AROUND A TREE**

**2 )** Shrubs and Bushes.

- a)** Select a shrub or bush that is alive and is not brittle, charred or loose.
- b)** To avoid leverage, locate the central root and construct the anchor as near to the base as possible.

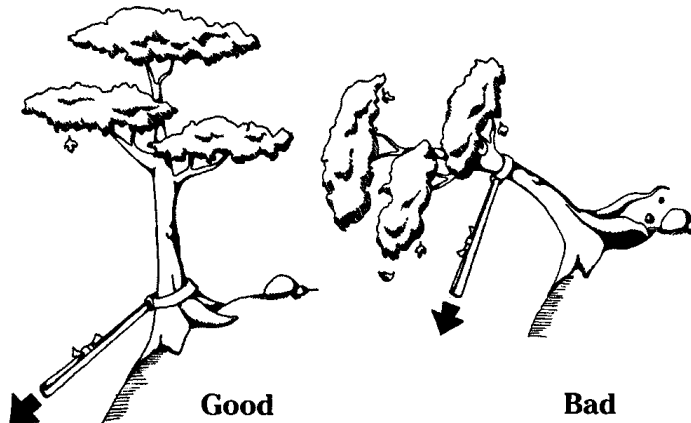

**PROPER AND IMPROPER PLACEMENT ON NATURAL ANCHORS**

**3 )** Rocks and Boulders.

- a)** Stability is of prime importance when considering a rock or boulder for an anchor. It must be strong enough and secure enough for the intended load.
- b)** All surfaces of the rock or boulder should be inspected for any rough or sharp points. These areas must be padded to protect the rope from being abraded or cut.

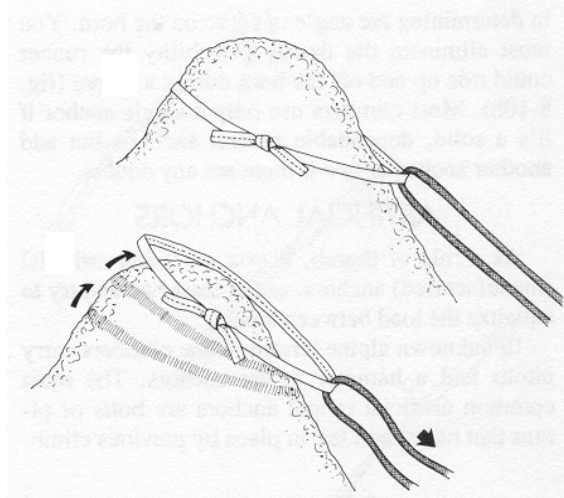

**PROPER AND IMPROPER PLACEMENT OF A RUNNER OVER A BOULDER**

**4 ) Spikes and Flakes.**

- a)** To check stability of a spike or flake, thump it with the heel of your hand. Anything that sounds hallow is suspicious.
- b )** They should be checked for cracks or other signs of weathering that may impair their firmness.
- c)** Sharp edges must be padded to protect the rope against cuts and abrasion.

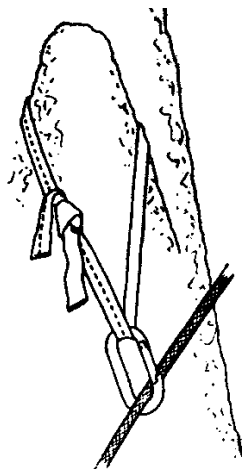

**RUNNER OVER A FLAKE**

**5 ) Threads and Chockstones.**

- a)** A thread is when the rock weathers or cracks to form a hole in the main wall. A chockstone is a rock wedged in a crack.
- b )** Check a thread by thumping it with the heel of your hand. Make a visual inspection for cracks and weather. Common sense will prevail for choosing this

type of anchor.

- c)** When choosing a chockstone, ensure that it has substantial contact with the crack and that the stone's symmetry corresponds with the intended direction of pull.

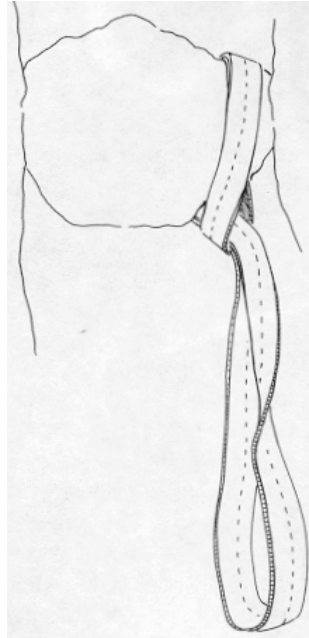

**RUNNER IN A GIRTH HITCH OVER A CHOCKSTONE**

- b.** Types of Natural High Tension Anchors. The following are types of Natural High Tension Anchor Systems used to construct installations. These can be tied on any suitable natural anchor point:

- 1.)** Tree Wrap Anchor. The tree wrap is an anchor used to relieve tension on the actual knot itself. This system requires more rope when tied around a large anchor point.

- a)** Tie a Figure 8 Loop on the standing end of the rope and wrap the 4-6 times around an anchor point.
- b )** Attach a locking carabiner through the knot's loop and clip it onto the running end of the rope.



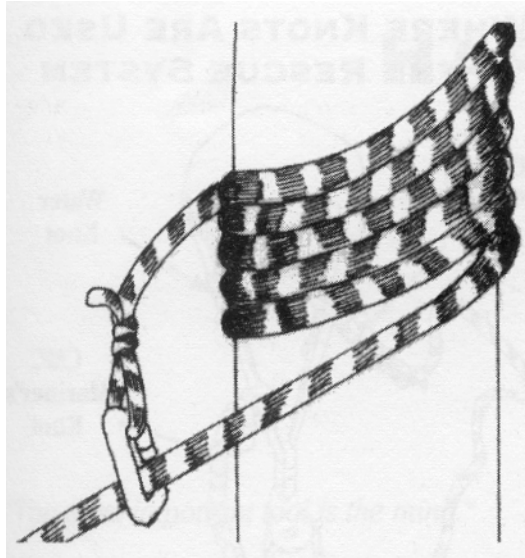

**TREE WRAP**

**NOTE:** If the anchor point to be wrapped is larger than 18' around, then three wraps will suffice.

**2**) **Swammi Wrap Anchor.** When tying the Swammi Wrap, ensure that the joining knot is kept on the side of the anchor point. The Swammi Wrap can be loosened under load if need be. This system can be substituted for a tree wrap when the installation's rope length is an issue.

**a)** Select a suitable anchor point and tie a Swammi Wrap around it.

**b)** Clip a locking carabiner into as many wraps as possible. This will serve as the attachment point for the anchor system.

**3**) **Figure of 8 Anchor.** The Figure of 8 Anchor is a quick and efficient system. This system cannot be loosened under load. It is tied in the following manner:

**a)** Tie a Figure of 8 Loop on the standing end of the rope and wrap the knot around a suitable anchor point. Attach a locking carabiner through the knot's loop and clip it onto the running end of the rope.

**(b)** Before tensioning the anchor system, adjust the tree wrap so that the running end of the rope runs smoothly through the carabiner towards the direction of pull. This will prevent any lateral tension.

**c)** If two ropes are used, the upper rope's carabiner has its gate upwards, and the lower rope's carabiner has its gate downward.

**c.** Primary and Secondary Natural Anchor Point System. The two anchor points should be

in line with the direction of pull. The primary anchor is the point nearest the running end while the secondary anchor point is directly behind the primary. It is constructed in the following manner:

- 1 ) The primary anchor knot should be an around the object clove hitch. This is chosen for ease of untying the system after tension has been placed on the rope.
- 2 ) The secondary knot is tied around a suitable anchor point ensuring that the rope is taunt between the two anchor points.
- 3 ) Only one anchor point is required when:
  - a) Using a tree with a diameter of 12" or more, and it can handle the intended load safely.
  - b ) When constructing a retrievable system.

**NOTE:** If constructing an anchor system in which only one natural anchor of less than 12" diameter exists, it must be backed up by two pieces of artificial protection.

**TRANSITION:** Now that we have discussed natural anchors, are there any questions? Let's move on to artificial anchors.

**4.** (10 Min) **ARTIFICIAL ANCHOR SYSTEMS.** Any time we use anything other than a natural feature, we are using an artificial anchor point. Artificial anchors can be constructed in the ground, or on the rock itself. The following are artificial anchor systems:

**a.** Single Timber Deadman. This system is constructed in the ground and it requires considerable time and effort. The steps of its construction are as follows:

- 1 ) Dig a trench 6 feet long and 3 feet deep and wide enough to work in at a 90 degree angle to the direction of the pull.

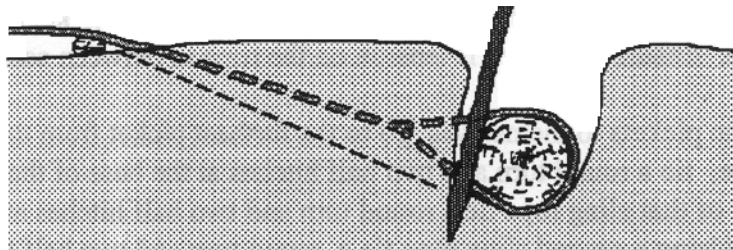

**SINGLE TIMBER DEADMAN**

- 2 ) Dig another trench about 12 inches wide. This trench is dug so that it intersects the main trench at a right angle in the middle. The bottom of this trench should be parallel to the direction of pull and should join the bottom of the main trench.

**3 )** Take an anchoring device (i.e. log, engineer stakes, bundled up branches etc.) that is strong enough to support the intended load. The anchor is placed into the main trench and covered with dirt with the exception of that part of the anchor that joins the second trench. Stakes approximately 3 feet long should be driven approximately 1-1/2 feet into the ground between the dead-man and the slanted side of the trench to assist in holding the dead-man in place if the soil is soft.

**b.** Picket Hold Fast. The picket hold fast is an easier anchor to construct than the deadman, and can be used almost anywhere. The strength of the picket system depends on the pickets and the soil or snow conditions. The picket system can be used for both high and non-tension systems. Construction is as follows:

#### **PICKET HOLD FAST**

**1 )** Three stakes (i.e. logs, engineer stakes, etc.) are driven into the ground at a 30 degree angle against the direction of pull.

**2 )** The line of pickets should be driven in line with the direction of pull. The distance between the pickets can be anywhere from 3-12 feet apart depending on the terrain and soil conditions.

**3 )** Before tying any rope to the picket anchors, the base of the pickets must be buffed or padded.

**4 )** To tie a rope to the pickets, go to the furthest picket away from the cliff edge. Tie a round turn and two half hitches at the base of the picket. Take the running end of the rope and tie an over the object clove hitch to the base of the middle picket. Then with the running end of the rope tie an over the object clove hitch to the picket closest to the edge of the cliff face. Ensure that there is tension on the rope in between each picket.

**5 )** To tie off the pickets to themselves, go to the furthest picket from the cliff edge. And with a sling rope, tie a round turn and two half hitches at the base of that picket. With the running end of that sling rope tie a round turn and two half hitches at the top of the middle picket. Using a second sling rope tie a round turn and two half hitches to the base of the middle picket. Then with the running end of that sling rope tie a round turn and two half hitches to the top of the picket closest to the cliff edge.

**c.** Equalized Anchor. This system is built with a minimum of three pieces of protection. It can be tied with the standing end of a rope or by utilizing a practice coil.

**1 )** Construction with the Standing End of the Rope:

- a) Tie a Figure of 8 Loop in the standing end of the rope.
- b) Place a carabiner in each artificial anchor point and attach the knot in either of the outside carabiners.
- c) Clip the rope into the remaining carabiners.
- d) A bight of rope is then pulled down after each carabiner into the anticipated direction of pull. With all three bights, tie an overhand knot around itself to include the running end of the rope.
- e) With the running end of the rope coming from the overhand knot, tie a Figure of 8 Loop and attach it to the overhand knot's loop with a locking carabiner.
- f) Ensure that there is sufficient slack in the dead rope to prevent a possible shock loading of the system.

2 ) Construction with the Cordalette Method:

- a) Create an endless loop with a practice coil and clip it into each of the artificial anchor points.

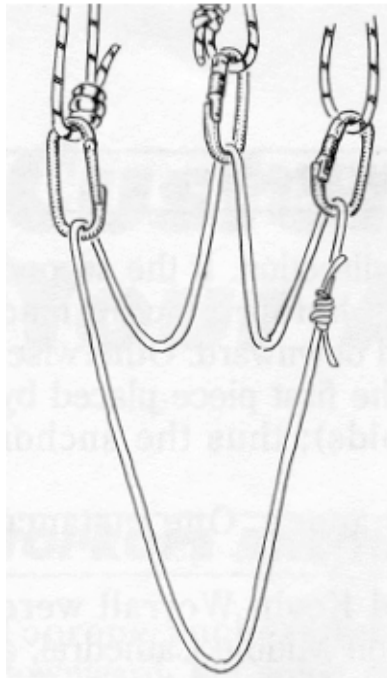

- b) A bight of rope is then pulled down between each carabiner into the intended direction of pull.

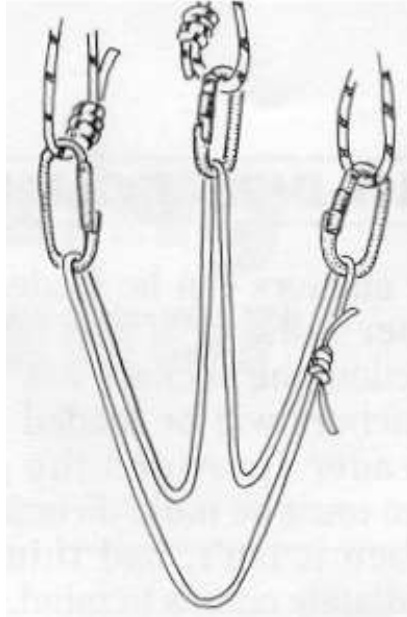

- c) With all three bights, tie an overhand knot on itself.
- d) Place a locking carabiner into the overhand knot's loop. This will serve as the attachment point for the anchor system.

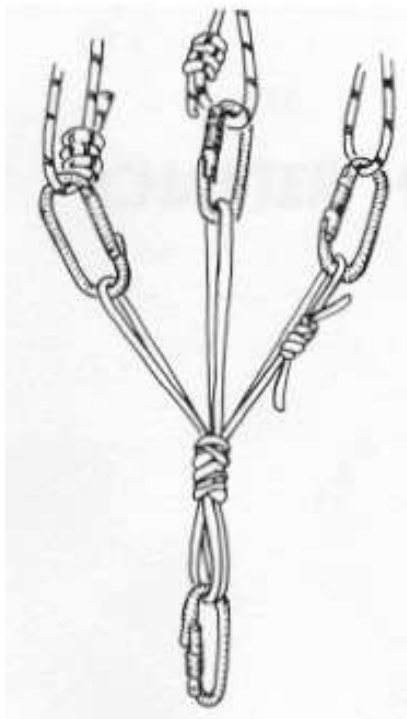

**NOTE:** If constructing a two-rope high-tension installation, a minimum of three artificial anchors per rope will be used.

TRANSITION: During this period of instruction we have discussed natural and artificial anchors, are there any questions? If you have none for me then I have some for you.

**PRACTICE**

(CONC)

- a. Students will establish natural and artificial anchor systems.

**PROVIDE HELP**

(CONC)

- a. The instructors will assist the students when necessary.

**OPPORTUNITY FOR QUESTIONS**

(3 Min)

**1. QUESTIONS FROM THE CLASS**

**2. QUESTIONS TO THE CLASS**

What are the two types of anchors?

- A. (1) Natural.
- (2) Artificial.

**Q.** How many pieces of protection are needed for an artificial anchor in a high tension installation, that requires two ropes?

**R.** A minimum of six pieces of protection.

**S.** What are the different types of artificial anchors?

**T.** (1) Single Timber Dead-man

- 2 ) Picket Hold fast
- 3 ) Chock Anchor System

**SUMMARY**

(2 Min)

- a. During this class we have looked at the two types of anchors, to include natural and the artificial anchors. We have discussed the methods of tying these anchors as well as criteria for anchor points.
- b. Those of you with IRF's please fill them out at this time and turn them into the instructor. We will now take a short break.

UNITES STATES MARINE CORPS  
Mountain Warfare Training Center  
Bridgeport, California 93517-5001

SML

SMO  
ACC  
02/11/02

**LESSON PLAN**

**MECHANICAL ADVANTAGE SYSTEMS  
FOR LIFTING AND TIGHTENING**

**INTRODUCTION**

(5 Min)

1. **GAIN ATTENTION.** Image yourself as a patrol leader conducting a patrol in a mountainous environment. You have a thirteen man patrol, who all have sling ropes, carabiners, and the squad has two 165' static ropes. Your patrol comes up to a swift moving stream, which cannot be crossed by foot and is 100' wide. The rope will reach across, but sags in the water endangering Marines by drowning. The rope must be tightened to keep the Marines out of the water and aid in the crossing. This class will demonstrate and apply the physics of tightening a rope through mechanical advantage.
2. **OVERVIEW.** The purpose of this period of instruction is to introduce the student to the basics of mechanical advantage and the different types of pulley systems used. This period of instruction relates to all high tension systems.
3. **METHOD/MEDIA.** The material in this lesson will be presented by the lecture and demonstration method. You will practice what you have learned in the one rope bridge class practical application. Those of you with IRF's please fill them out at the end of this period of instruction.
4. **EVALUATION.** This period of instruction has no learning objectives and students will be evaluated throughout their training. The procedure of mechanical advantage will be tested on the one Rope Bridge.

**TRANSITION:** Are there any questions over the purpose, learning objectives, how the class will be taught, or how you will be evaluated? Let's discuss the theory behind the mechanical advantage system.

## **BODY**

(50 min)

1. (10 Min) **BASIC THEORY OF THE MECHANICAL ADVANTAGE SYSTEM.** How can a man weighing 200 pounds lift a load three times above his weight with ease?

- a. Consider first the heavy block in the diagram below suspended from two ropes. The upward force on the block is the tension in the ropes, and the sum of the two tensions must equal the weight of the block. If the whole system is symmetrical, each rope is under tension equal to half the weight of the block.

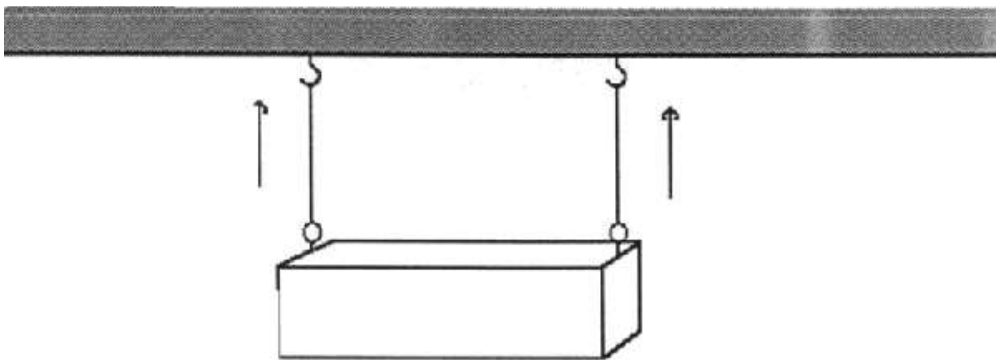

- b. Now look at the diagram below where the block has been attached to a pulley. There is now only one rope, which passes through the pulley. The tension in the rope is the same throughout; if it were different on one side than on the other, the pulley would turn until the tension on the two sides equalized. The tension in the rope is still only half the weight of the block.

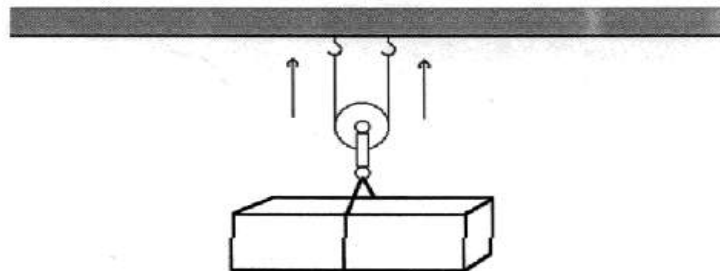

- c. The Work Principle



- (1) Webster's definition of work states that; work is an activity in which one exerts strength or faculties to do or perform something. It is a sustained physical or mental effort to overcome obstacles and achieve an objective or result. What kind of advantage can we achieve using Pulley systems to reduce the amount of work we do?
- (2) While pulleys are useful, they do not give something for nothing. Ignoring the problem of friction (force which opposes the movement of one surface sliding or rolling over another with which it is in contact), the input and output forces are in inverse ratio to the respective distance. To solve this we use this formula:

$$\frac{\text{EFFORT}}{\text{LOAD}} = \frac{\text{LOAD DISTANCE}}{\text{EFFORT DISTANCE}}$$

**EXAMPLE:** If you have a log that weighs 100 lbs. And you need to lift it two feet, using a 2:1 ratio system, the formula is:

$$\frac{50}{100} = \frac{2 \text{ feet}}{4 \text{ feet}}$$

- (3) The frictionless pulley does not alter the product of force and distance. There is another limitation on the definition of work. Only the force in the direction of motion counts. What does this mean? The angle on which you direct the pull of your system will determine the actual advantage that it will receive. *REFER TO NATURAL AND ARTIFICIAL ANCHORS*

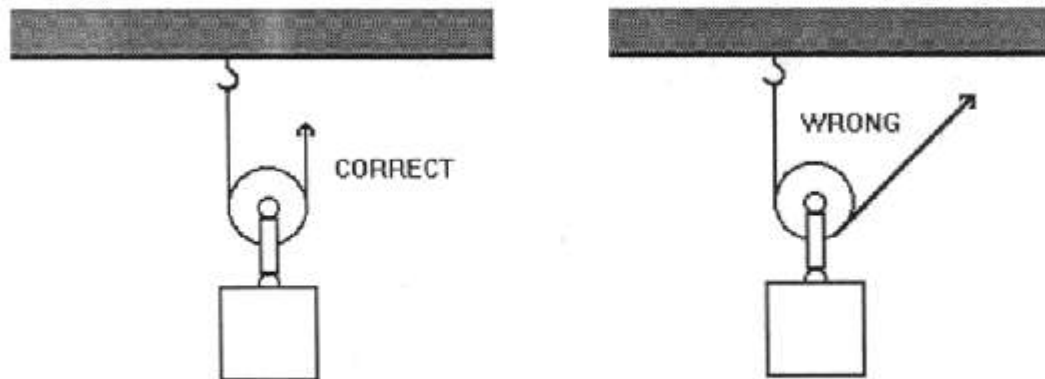

**TRANSITION:** Are there any questions over the basic theory? Let's now discuss the construction of various ratio systems.

2. (30 Min) **CONSTRUCTION OF THE RATIO SYSTEMS.**

- a. Construction of a 1: 1 ratio system

- (1) Attach the pulley to a suitable anchor point.
- (2) Anchor one end of the rope to the load.
- (3) Run the other end of the rope through the pulley.
- (4) To equalize the load, pull the rope until there is tension on the system. If the load weighs 100 lbs., theoretically it should only take 100 lbs. of force to lift the load, but due to friction it may require 110 lbs. of force to equalize the load. To lift the load one foot, you will have to pull the rope one foot.
- (5) This is referred to as a directional pulley or redirect, and gives no mechanical advantage at all.

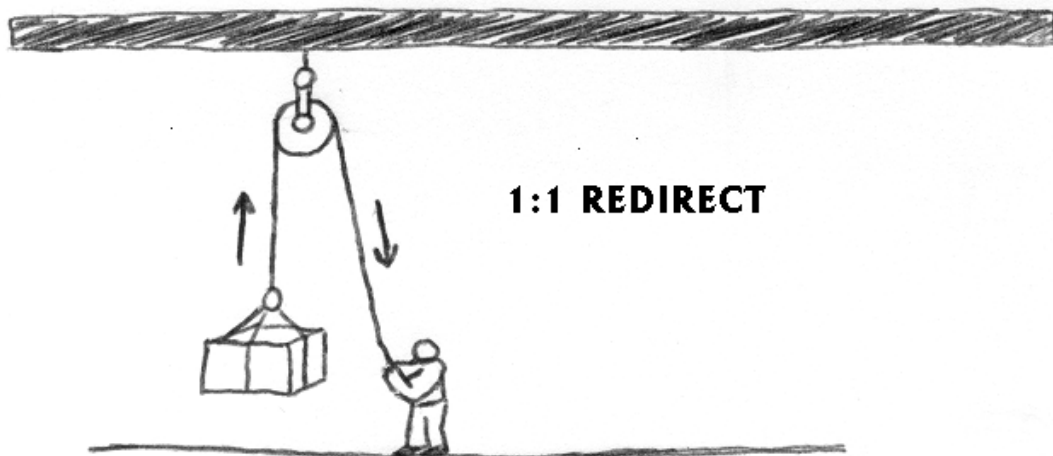

- b. Construction of the 2:1 ratio system (C-pulley).
- (1) Attach one end of the rope to a suitable anchor.
  - (2) Attach a pulley to the load.
  - (3) Run the other end of the rope through the pulley.
  - (4) Now you can raise the load with the amount of force that is equal to half of its weight.

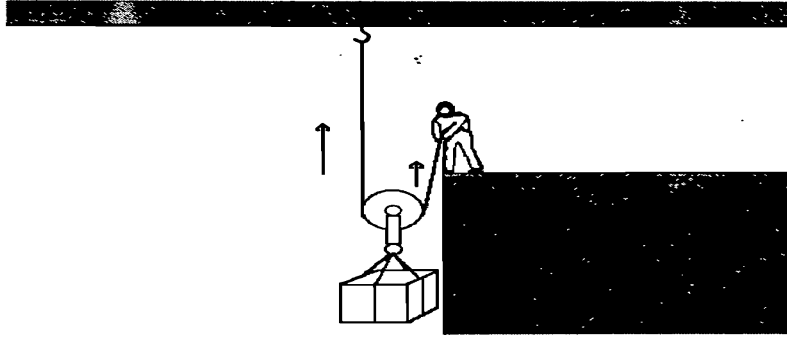

### 2:1 RATIO SYSTEM

- (5) To lift the load two feet with this system, you must pull four feet of rope through the pulley.
- (6) When each rope is equalized, divide by two. So if the load weighs 100 lbs., each line has 50 lbs. of supported weight.

#### c. Construction of the 3:1 ratio system (Z-Pulley)

(1) For tightening a rope installation:

- (a) Anchor one end of the rope to a suitable far anchor using the tree wrap method.
- (b) Tie a swami wrap around the near anchor and clip a steel-locking carabiner with the gate up and large axis facing the far anchor. This carabiner is referred to as the Main Anchor Carabiner (MAC).
- (c) Take the running end of the rope from the far anchor and clip it into the MAC. Tie a stopper knot (Auto block), with a short prusik on the rope and attach it back into the MAC and lock it down.

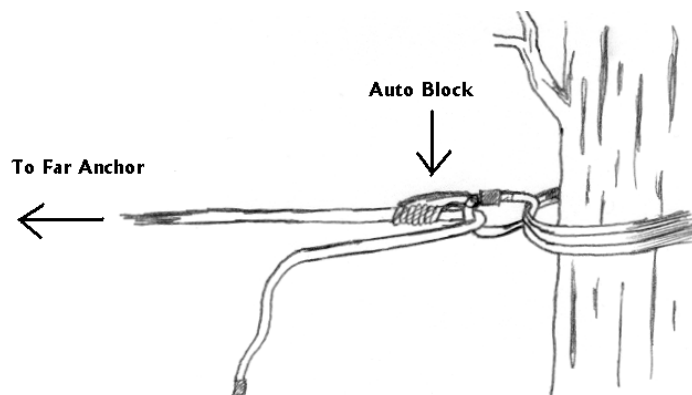

### AUTO BLOCK

- (d) Using another short prusik, come out from the swami wrap a few feet and tie a stopper knot (French prusik) on the rope and clip a steel locking carabiner into it

with the direction of pull towards the near anchor. Clip the running end of the rope from the Auto block into the carabiner and lock it down.

- (e) Now pull the running end of the rope to tighten the rope installation.

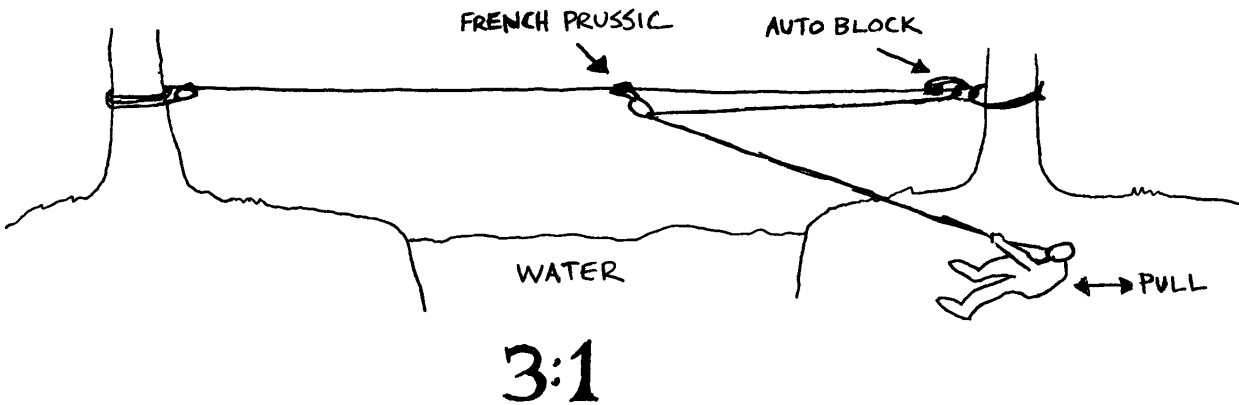

#### TIGHTENING A 3:1 MECH ADVANTAGE

- d. Construction of the 9:1 ratio system (Z-Z Pulley)

(1) For tightening a rope installation:

- (a) Anchor one end of the rope to a suitable far anchor using the tree wrap method.
- (b) Tie a swami wrap around the near anchor and clip a steel locking carabiner through all the wraps with the gate up and large axis facing the far anchor. This carabiner is referred to as the Main Anchor Carabiner (MAC).
- (c) Take the running end of the rope from the far anchor and clip it into the MAC. Tie a stopper knot (Auto block), with a short prusik, on the rope and attach it back into the MAC and lock it down.
- (d) Using another short prusik, come out from the swami wrap a few feet and tie a stopper knot (French prusik) on the rope and clip a steel locking carabiner into it with the direction of pull towards the near anchor. Clip the running end of the rope from the Auto block into the carabiner and lock it down.
- (e) Take the running end of the rope back to the swami wrap; attach another steel locking carabiner into the MAC with the large axis facing down and out to the far anchor. Clip the rope into this carabiner and lock it down.

#### CARABINER INTO THE MAC

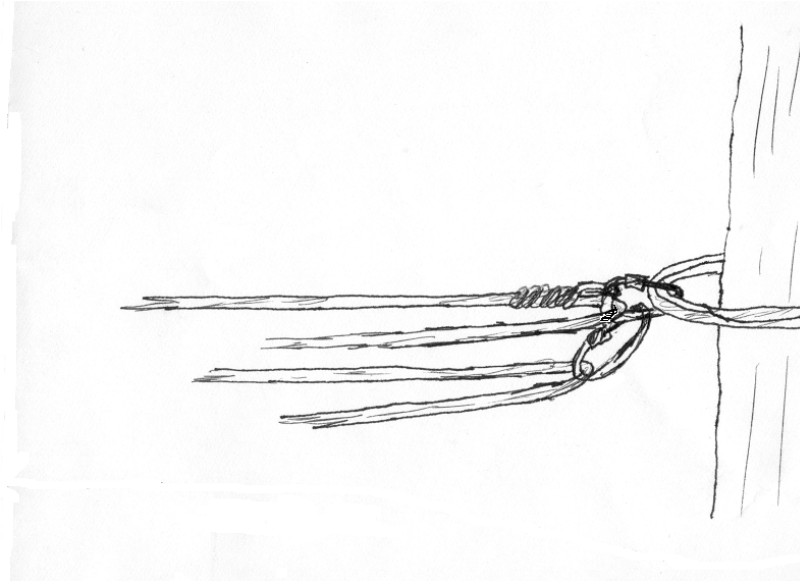

- (f) Holding the rope that runs between the 2<sup>nd</sup> stopper knot and the carabiner hanging from the MAC, go back to a few inches before the French prusik and tie a 3<sup>rd</sup> stopper knot (French prusik) on that line of rope with a steel locking carabiner attached to it. Take the running end of the rope and clip it into the carabiner and lock it down.

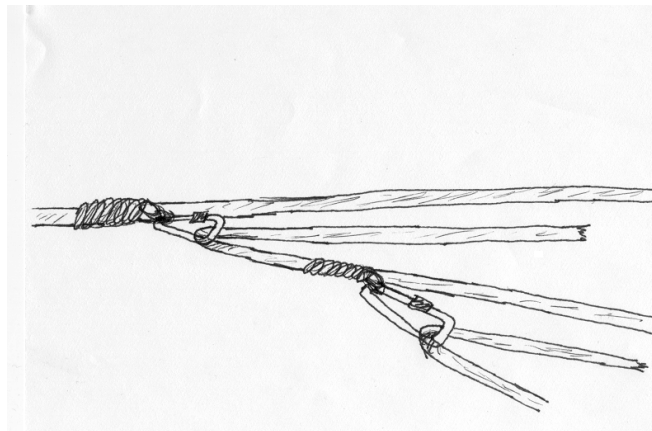

**CLIPPING INTO THE PRUSIKS**

- (g) Now pull the running end of the rope to tighten the rope installation.

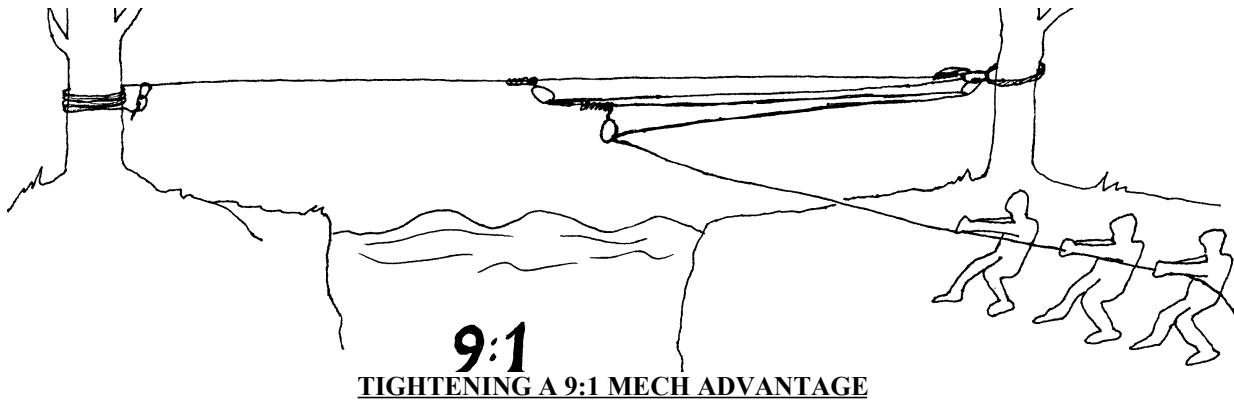

**NOTE:** Care must be taken when increasing the ratio system. Breakage and damage of the ropes, carabiners and pulleys is very possible if the force end of the rope is greater than the load end of the rope. **No more than two men will tension the installation at any time if using pulleys.**

**TRANSITION:** Are there any questions over the construction of the systems? Because we are Marines, we are used to carrying a great deal of weight. But when we are in the mountains we should take every opportunity to lighten our loads and reduce the amount of work we need to do. If you have no questions for me, then I have some for you.

**PRACTICE** (CONC)

- a. Students will use a mechanical advantage system to tighten a rope installation. Practical application of this will be on the one Rope Bridge.

**PROVIDE HELP** (CONC)

- a. The instructors will assist the students when constructing the one Rope Bridge.

**OPPORTUNITY FOR QUESTIONS** (3 Min)

**1. QUESTIONS FROM THE CLASS**

**2. QUESTIONS TO THE CLASS**

Q. What are the two practical uses for the mechanical advantage system?

- A. (1) As a tightening system.
- (2) As a device to raise personnel or equipment up steep or vertical terrain.

**SUMMARY** (2 Min)

- a. During this period of instruction we have discussed the terms and definitions, the practical uses, the equipment required for the construction of the 2:1 (C-Pulley), the 3:1 (Z-Pulley) and the 9:1 (Z-Z Pulley) ratio systems.
- b. Those of you with IRF's please fill them out at this time and turn them in to the instructor. We will now take a short break.

UNITED STATES MARINE CORPS  
Mountain Warfare Training Center  
Bridgeport, California 93517-5001

SML  
SMO  
ACC  
02/11/02

**LESSON PLAN**

**ONE-ROPE BRIDGE**

**INTRODUCTION**

(5 Min)

- 1. GAIN ATTENTION.** At times in mountainous terrain, it will become necessary to cross-rivers or streams. If the obstacle is a river, it can normally be crossed by utilizing various fording techniques. If it is a ravine, you may have to rappel down one side and scramble up the other. The most expeditious technique that can be used for crossing such an obstacle, particularly where a large body of men are involved, is by the use of a man portable easily erected and dismantled rope bridge.
- 2. OVERVIEW.** The purpose of this period of instruction is to provide the students with the necessary skills required to cross-streams using a one-rope bridge. This material will be covered by discussing site selection, how to estimate the distance to be crossed, construction, crossing techniques, rescue techniques, and retrieving the bridge. This lesson relates to mountain movement.

**INSTRUCTOR NOTE:** Have students read learning objectives.

**3. INTRODUCE LEARNING OBJECTIVES**

**1. TERMINAL LEARNING OBJECTIVES.** In a summer mountainous environment, conduct bridging, in accordance with the references.

**2. ENABLING LEARNING OBJECTIVES** (SML) and (ACC)

**1 )** Without the aid of references, list in writing the criteria for site selection for a one-rope bridge, in accordance with the reference(s).

**2 )** Without the aid of references, given a MAC Kit, and a simulated or actual obstacle, construct a one rope bridge, in a specified time limit and in accordance with the references.

**3 )** In a summer mountainous environment, cross a one-rope bridge using the rappel seat



method, in accordance with the reference(s).

4 ) In a summer mountainous environment, execute a rescue on a one-rope bridge, in accordance with the reference(s).

5 ) In a summer mountainous environment, retrieve a one-rope bridge, in accordance with the reference(s).

6 ) Without the aid of references, list in writing the rescue techniques, in accordance with the reference(s).

### 3. ENABLING LEARNING OBJECTIVES (SMO)

1 ) With the aid of references, list orally the criteria for site selection for a one-rope bridge, in accordance with the reference(s).

2 ) With the aid of references, given a MAC Kit, and a simulated or actual obstacle, construct a one rope bridge, in a specified time limit and in accordance with the references.

3 ) In a summer mountainous environment, cross a one-rope bridge using the rappel seat method, in accordance with the reference(s).

4 ) In a summer mountainous environment, execute a rescue on a one-rope bridge, in accordance with the reference(s).

5 ) In a summer mountainous environment, retrieve a one-rope bridge, in accordance with the reference(s).

4. METHOD/MEDIA. The material in this lesson will be presented by lecture and demonstration. You will practice what you have learned in upcoming field training exercises. Those of you with IRF's please fill them out at the end of this period of instruction.

### 5. EVALUATION

a. MLC- You will be tested later in the course by written and performance evaluations on this period of instruction.

b. SMO - You will be tested by a verbal exam and by a performance examination.

TRANSITION: Are there any questions over the purpose, learning objectives, how the class will be taught, or how you will be evaluated? During this period of instruction we will discuss site selection, construction, retrieving, and crossing the one rope bridge. Let's move on to the first objective, site selection.

**BODY**

(65 min)

**1.** (5 Min) **SITE SELECTION**

**a.** The two criteria for site selection for a one-rope bridge are:

**1** ) There must be suitable anchors on both sides of the stream.

**2** ) The anchors must offer good loading and unloading platforms.

**b.** Other considerations involved are:

**1** ) The site chosen for the initial crossing does not have to be at the location for the construction of the bridge, just as long as the rope can be taken to the selected site the crossing.

**2** ) The site chosen for the lead swimmer to cross should be as free as possible from obstacles in the water, such as large boulders, stumps or logs as discussed in *STREAM CROSSING*.

**3** ) The anchors must be close enough for the 150 foot coil to reach both near side and far side anchors. Keep in mind that it will take approximately 1/3 of the 150 foot rope for tightening and anchoring of the bridge.

**2.** (5 Min) **DISTANCE ESTIMATION**. The follow methods can be used to determine the distance between anchor points:

**a.** Azimuth Method. Shoot an azimuth to a point on the far side of the intended obstacle to cross. Then move LEFT or RIGHT (perpendicular to the azimuth) until you get a 15 degree offset of your previous azimuth. Next, measure the distance that you paced in feet from your first azimuth to your second azimuth, and multiply that distance by three. This total will give you the approximate distance across the obstacle in feet.

**b.** Unit Average Method. Get three Marines to judge (best guess) the distance across the intended obstacle. Add up the total accumulated distance, then divide by three. This will give an estimation of the distance across the obstacle.

Example:      Marine 1      240 ft  
                         Marine 2      230 ft  
                         Marine 3      250 ft  
   720 ft

Divided by 3 = 240 ft

**3.** (2 Min) **ORGANIZATION**. The organization of construction is broken down into four groups. They are as follow:

- a. The Bridging Team - consisting of the bridge NCO and another Marine.
  - b. The Safety Line Team - consisting of the lead swimmer and his belay man.
  - c. The Mule Team - consisting 3 Marines for a 9:1, and 6 Marines for a 3:1.
  - d. The Security Team – consisting of the rest of the party.
4. (15 Min) **CONSTRUCTION**. This bridge is ideal for squad and platoon sized units, for its quick construction and minimal amount of equipment required.
- a. Once the site for the bridge has been designated by the bridge NCO, the Safety Line Team will move up stream from this site to enter the water. Their first step is to flake out the rope. Once this is accomplished, the lead swimmer's will take a bight of the rope and tie a figure 8 loop at the end that will be going to the far side, ensuring the knot has a 18"-24" loop. The lead swimmer's upstream arm will go in it, with the belay man tending his rope the lead swimmer will cross the never using the flow to assist him. (Ferry angle as taught in STREAM CROSSING)
  - b. At the same time as the lead swimmer is crossing, the bridging team will be preparing the near side anchor. The bridging team will tie a swammi wrap around the anchor, using a sling rope or practice coil, and ensuring the square knot is behind or on the side of the anchor. Once the anchor is secure, flake out the bridging line in order to send it across.
  - c. Once the lead swimmer is across he will move to the site where the far side anchor will be established and secure his rope. The belay man will then move down to the near side anchor, and as close to the waters edge as possible. He will attach the bridging line to the safety by tying a middle of the rope in a figure 8 knot to the safety line and an end of the rope figure 8 knot to the bridging line connecting the two ropes with an 85 carabiner. The lead swimmer will then pull the rope across. The belay man with the help of another Marine will belay the bridging line across keeping tension on the rope to keep the rope out of the water.
  - d. After the bridging line is across the lead swimmer will detach the bridging line from the safety line and secure it to the far side anchor using a tree wrap, wrapping from right to left, ensuring there are 3-5 wraps.
  - e. Once the bridging line is secure. The lead swimmer and the belay man will secure the safety line on both banks, ensuring the rope is creating a ferry angle (minimum 45 degrees). This will be the safety line for the Marines crossing the bridge.

**NOTE:** If a fall from a rope bridge would result in death or serious injury, then utilize a safety line that will be anchored parallel with the bridge and hand tightened. The Marine crossing will clip into both ropes prior crossing.

**f.** On the near side bank:

**1.** The bridging team will need the following gear to build the mechanical advantage:

(a) Four steel locking carabiners & 3 -Three foot prusiks

**2.** Once the bridging line is secured on the far side, the bridging team will take one 85 and clip it into the near side anchor (swammi wrap). Then they will take the bridging line and clip into that 85, then using one three foot long prusik (16" loop) the bridging line will be secured to the 85 by tying a French Prusik, which will act as a braking knot. The bridging team will now pull the rope taut, and begin construction of the mechanical advantage.

**3.** The first step is to take one three foot prusik (16" loop) and tie a French prusik on the bridging line as far away from the anchor as possible. Then take one 85 and clip it to the loops of the French prusik.

**4.** Taking a bight from the running end of the rope clip it into the 85 hanging from the tails of the French prusik.

**5.** Then bring a bight back from the clipped in rope to the anchor, and taking one 85 clip it into the 85 created in step (2), take the bight of rope and clip into this 85.

**6.** Take one three foot prusik and tie a French prusik onto the bottom end of the bight clipped into the 85 created in step (3), take one 85 and clip it into the tail loops of the

French prusik.

- 7.** From the anchor, take a bight of rope from the 85 created in step (6) and clip it into the 85 created in step (6).
- 8.** You have made approximately a 9:1 mechanical advantage.

**NOTE:** If the manpower is available the squad/platoon has the option of building a 3:1 mechanical advantage vise a 9: 1, the mule team will just have to add another body having no more then 3 bodies on a 9:1 and 6 bodies on a 3:1

**g.** Tensioning of the Bridge

- 1.** Now that the bridge is built, the bridge NCO can call up the mule team to tension the bridge.
- 2.** This procedure is facilitated by the mechanical advantage system that was just put into place. The braking knot (French prusik) is used to hold tension on the bridging line while the bridge is being tensioned.
- 3.** The mule team will begin to pull on the running end of the rope coming out of the mechanical advantage. They will pull the rope straight back, trying to keep it in line with the bridge as best as possible.
- 4.** The mule team will tension the rope as much as possible, the bridge NCO will monitor the system. Once the mule team cannot pull anymore tension, the bridge NCO will then have them hold the rope in place, and will reset the braking knot. Once the braking knot is set the bridge NCO will ask for slack from the mule team and cycle the system out. This process will continue until the bridge is tight.
- 5.** On the last cycle the bridge NCO will set the brake knot and with the help of another Marine they will make a bight out of the running end and bring it around the tree while keeping tension.
- 6.** Take a bight and make a complete round turn on the body of the 85 created in step (2). Last, the bridge NCO will tie two half hitches encompassing all the ropes just behind the anchor.
- 7.** At this stage the bridge is tight and secured, the bridge NCO will now call up the remainder of the squad/platoon to cross. The bridge NCO will monitor the crossing of all Marines, and will be the last one to cross.

**TRANSITION:** Now that we have discussed the construction of the bridge, are there any questions over the material? Next we will discuss the crossing of the bridge.

**5.** (10 Min) **CROSSING.** The method used to cross is known as a horizontal traverse. This traverse can be accomplished in the following ways.

**a.** Rappel Seat Method

- 1**) The Marine ties himself into a rappel seat and inserts a large steel locking carabiner with the gate facing down and away.
- 2**) The Marine faces the bridge with his right hand towards the near anchor to snap into the bridge, once the 85 is locked onto the bridge rope, a helper flips the 85 over so that the locking nut screws down. A carrier rope with a girth hitch may be added to assist the Marine in mounting the rope.
- 3**) The Marine hangs below the bridge from his rappel seat with his head pointing in the direction of the far anchor and allows his legs to hang free.
- 4**) Pulling with his arms makes progress.
- 5**) This method is the safest and therefore the preferred method.
- 6**) If the Marine must take a pack across, he may wear it with the waistband secured: However, the preferred method is to have another carabiner (aluminum non-locking is sufficient) attached to the pack frame at the top and attach this to the bridge behind the Marine putting his legs through the shoulder straps and pulling the pack across with him.
- 7**) One man at a time will cross, although one can load and another can unload concurrently.
- 8**) Weapons will be worn across the shoulder; muzzle down with a tight sling securely attached to the weapon.

**b.** Pulley Method. This method is used when the one rope bridge is long, uphill, or speed is vital and the Marines crossing it have a lot of heavy personal equipment; M24OG's, radios, etc.

- 1**) Equipment required. One pulley, four steel locking carabiners, and a hauling line twice the length of the obstacle.
- 2**) Setting up the system. Construction of the first suspension point is done by attaching a pulley to the one rope bridge, one 85 carabiner is attached to the pulley, gate down, and a second 85 is attached to the first 85 with the gate facing the near side bank. Into this second 85, attach the hauling rope with a figure-8 loop. The figure-8 is placed halfway along the hauling rope and attached to the 85, which is then locked. Four feet down the line another figure-8 on a bight is placed into the second suspension point.

**3**) Connection. The Marine clips his 85 into the lower 85, his equipment is clipped into the second 85. The mule team starts to pull.

**c.** Helmets will be worn for all methods of crossing the bridge. Gloves are optional.

**NOTE:** There are additional methods of crossing a one rope bridge such as the Commando crawl, Monkey crawl and hand over hand techniques, however, they are not taught at MWTC due to safety reasons.

**TRANSITION:** Are there any questions over crossing? Now we will cover rescue techniques.

**6.** (8 Min) **RESCUE TECHNIQUES.** If an individual is unable to complete the crossing on the one rope bridge using the rappel seat method of crossing (i.e. from a fall or exhaustion), a rescue will have to be made in the following manner:

**a.** Reach. First try to reach the victim by using an object such as a pole, your hand, if the victim is close enough, etc ...

**b.** Throw. If reaching the victim is impossible, try throwing a rope to the victim and have him attach the rope to himself, preferably his seat, and pull him back to the desired side of the installation.

**c.** Tow. If the victim is unable to catch or reach a rope being thrown to him or the victim is unconscious, tie a figure-of-eight loop into the middle of the safety line and then connect the rope to the rope bridge with a steel locking carabiner. The mule team will pull the carabiner up against the victim's seat and begin towing the victim to the desired side of the installation. The rope used to tow the victim should be twice the length of the span of the rope bridge (If necessary, ropes can be tied together to accommodate the span). This will allow towing from either side without having to throw or have a Marine carry the safety line back across the bridge each time a towing rescue is performed.

**d.** Go. If all else fails, the last option will be to go after the victim. The rescuer will move out onto the rope bridge with a safety line attached to himself at approximately eight feet from the end of the safety line. In the end of the safety line tie a figure-of-eight loop and insert a steel locking carabiner in the end of it. Once the rescuer has made contact with the victim. He will attach the steel locking carabiner to either the victim's seat (preferably the victim's carabiner that is attached to the rope bridge), or to the bridge itself. To ensuring that the carabiner is placed so that it pulls against the victim's carabiner. The mule team now starts to pull both the victim and the rescuer to the desired side of the installation.

**e.** Cut. If while crossing the rope over water the individual goes underwater and no other rescue technique can be employed, the rope will be cut.

TRANSITION: Are there any questions over rescue techniques? Now we need to know how to retrieve our ropes.

**7.** (10 Min) **RETRIEVING THE ONE ROPE BRIDGE**

- a.** Before the bridge NCO sends the last Marine to cross, they must make the bridge retrievable.
- b.** The first step is to break down the mechanical advantage, ensuring the braking knot is set before doing so. The system will be broken down until the bridging line is attached only to the brake knot.
- c.** They will now take the rope around to the back of the anchor, and tie a slip figure 8, with the loop of the slip 8, take it and attach it to the bridging line just in back of the braking knot with a 85.
- d.** Now pull the running end coming out of the slip 8 until it tightens, and bites on the rope. Once the rope bites, tie a thumb knot behind the slip 8 as close to the slip figure 8 as possible.
- e.** The bridge NCO, with the help of another Marine, will now untie the swammi wrap, until all of the tension is on the bridging line.
- f.** The safety line will now be brought up, and attached to the end of the bridging line with an overhand knot.
- g.** The bridge NCO and the other. Marine will now cross the bridge.

**NOTE:** It is possible that the bridge may lose tension after breaking the bridge down. The packs of the last two Marines across can be sent over with other Marines, prior to the slip figure being tied.

- h.** After both Marines have crossed, the safely line will be brought up from down stream.
- i.** The tree wrap will now be taken off. Once the tree wrap is off, all knots and carabiners



will be taken out.

- j.** The safety line will now be pulled, the bridge is retrieved.

**TRANSITION:** When in mountainous terrain it is important to be aware of the fact that you may encounter a great variety of terrain in a very short time. Employing a rope bridge is a very worthwhile skill. Are there any questions over the retrieving the bridge or any thing covered in this class. If you have none for me, then I have some for you.

**PRACTICE**

(CONC)

- a.** Students will construct a rope bridge, cross it and retrieve it.

**PROVIDE HELP**

(CONC)

- a.** The instructors will assist the students when necessary.

**OPPORTUNITY FOR QUESTIONS**

(3 Min)

**1. QUESTIONS FROM THE CLASS**

**2. QUESTIONS TO THE CLASS**

**Q.** What are the two criteria for site selection for one-rope bridge?

**A.** (1) Suitable anchors on both sides of the stream.

**2.)** Good loading and unloading platforms.

**Q.** What are the two different methods used to cross a one-rope bridge?

**A.** (1) Rappel-seat method.

(2) Pulley method.

**SUMMARY**

(2 Min)

- a.** We have discussed the site selection, construction, crossing and retrieval of a one-rope bridge.
- b.** Those of you with IRF's please fill them out at this time and turn them in to the instructor. We will now take a short break.

UNITED STATES MARINE CORPS  
Mountain Warfare Training Center  
Bridgeport, California 935-17-5001

SMO  
SML  
ACC  
02/11/02

**LESSON PLAN**

**A-FRAMES**

**INTRODUCTION**

(5 Min)

- 1. GAIN ATTENTION.** In mountain operations it is often necessary to move inexperienced troops and equipment over steep, rocky terrain. A fixed rope installation is one method to move personnel up or down these obstacles. However, this method is not always sufficient for moving their equipment. So, the construction of a vertical hauling lines system may be necessary.
- 2. OVERVIEW.** The purpose of this period of instruction is to provide the student with the necessary information to establish A-frames for use with evacuating patients and moving gear up and down steep cliffs. This will be accomplished by discussing the definitions, purposes, criteria of site selection, and usage of these devices. This lesson relates to vertical hauling lines and suspension traverse.

**INSTRUCTOR NOTE:** Have students read learning objectives.

**3. INTRODUCE LEARNING OBJECTIVES**

**a. TERMINAL LEARNING OBJECTIVES.** In a summer mountainous environment and given the necessary equipment, construct an A-Frame, in accordance with the references.

**b. ENABLING LEARNING OBJECTIVES.** (SML) and (ACC)

**1 )** Without the aid of references, state in writing the definition of an A-Frame, in accordance with the reference.

**2 )** Given A-Frame poles, 6 sling ropes and an anchoring rope, construct an A-Frame, in accordance with the reference.

**c. ENABLING LEARNING OBJECTIVES (SMO).**

**1**) With the aid of references, state orally the definition of an A-frame, in accordance with the references.

(2) Given A-Frame poles, 6 sling ropes and an anchoring rope, construct an A-Frame, in accordance with the reference.

**4. METHOD/MEDIA.** The material in this lesson will be presented by lecture and demonstration. You will practice what you have learned during upcoming field training exercises. Those of you with IRF's please fill them out at the end of this period of instruction and pass them forward.

**5. EVALUATION**

**a.** MLC - You will be evaluated later in this course by written and performance examination.

**b.** ACC - You will be tested later in the course by written on this period of instruction and by performance evaluations during the cliff assault.

**c.** SMO - You will be tested by a verbal examination and also by a practical application method.

TRANSITION: Are there any questions over the purpose, learning objectives, how the class will be taught, or how you will be evaluated? We will start by discussing the A-frame.

**BODY**

(60 Min)

**1.** (15 Min) **A-FRAME.** Natural objects such as trees, bushes and boulders can be utilized to gain height in a rope installation. There are different artificial devices that can be used for the same purpose, one example being the A-Frame.

**a.** Definition. An A-Frame is an artificial device used to gain height in a rope installation. Although an A-Frame can be used with various types of rope installations its most common use is in conjunction with a vertical hauling line.

**b.** Materials. The materials required for construction of an A-Frame are:

**1**) Two-poles approximately 8 feet long and not less than 3 inches in diameter. The actual size of the poles will depend on the type of load; a very heavy item would require a stout pole and a taller item would require a longer pole to provide sufficient clearance for the load.

**2**) To construct an A-Frame, 4-6 sling ropes are required. This number may vary depending on the diameter of the poles and the length of the sling ropes being used.

**c.** Nomenclature.

**1**) Apex. The point near the top of the A-Frame where the poles cross each other.

**2**) Butt ends. The bottom ends of the poles used in construction of the A-Frame. The butt end is larger in diameter than the end at the apex.

TRANSITION: Now that we have discussed what an A-Frame is, are there any questions? Now we are ready to learn how to actually construct an A-frame.

**2.** (35 Min) CONSTRUCTING AN A-FRAME.

- a.** Place two sturdy poles of approximately the same length side by side, ensuring that the butt ends are flush together.
- b.** Take a sling rope and come down 18 inches from the top of the shortest pole leaving an 18 inch pigtail extended. Next, tie a clove hitch ensuring that the 18 inch pigtail is toward the top of the pole and the locking bars of the clove hitch are to the outside.
- c.** Wrap the sling rope 6-8 times horizontally around both poles, hitch down toward the butt ends.
  - 1**) It will be necessary to join another sling rope to the sling rope that you started with. The knot used to join the sling ropes is a square knot finished with two overhand knots.
  - 2**) The joining of the sling ropes must be done on the horizontal wraps and the square knot must be on the side of one of the poles so it will not interfere with the vertical wraps.
- d.** Wrap 4-6 times vertically between the poles and around the horizontal wraps.
- e.** Tie off the sling by using the 18 inch pigtail that extends from the clove hitch; tie it off by using a square knot. The square knot should be so tight that the overhands will be tied on the pigtails themselves.

The square knot should not be tied on the inside of the apex.

**f.** Spreader Rope (Bar)

- 1**) Tie a sling rope or ropes between the poles at the bottom of the A-Frame with a clove hitch with locking bar facing out and two half hitches on both butt ends.
- 2**) If more than one sling rope is needed, join the sling ropes with a square knot finished with two overhand knots. Make sure the ropes are joined in the middle of the A-Frame.

**NOTE:** During testing two sling ropes will be used for the spreader bar.

**3**) Adjustment can be made to either side when needed.

**g.** Anchoring the Butt Ends of the A-Frame

**1**) Place the butt ends of the A-Frame poles into natural or manmade pockets.

**2**) Use natural or artificial anchors to prevent the butt ends from moving. In order to keep the butt ends in place, additional anchors may be necessary along with anchoring the A-Frame at the middle and bottom. This is done with sling ropes in order to keep the A-Frame stationary. A clove hitch and two half hitches or a round turn and two half hitches are tied to the A-Frame and normal anchor knots are used on the anchors.

**h.** Anchoring and tying-off the A-Frame.

**1**) The top part of the A-frame (the Apex) is normally anchored off. There are a few different techniques used in anchoring off the A-frame. The installation being used will dictate how it is to be anchored. (This will be discussed later in *VERTICAL HAULING LINES and SUSPENSION AND TRAVERSE*)

**i.** Task organization for the A-Frame. To construct the A-Frame quicker and more efficiently, separate tasks can be assigned to different individuals. The following tasks should be assigned:

**1**) One individual will tie the sling ropes around the poles to form the apex.

**2**) While the apex is being tied another individual should be constructing the anchor. After the spreader bar is completed, this individual will anchor down the A-Frame.

**3**) Once the poles are spread, a third Marine should tie the spreader bar. Ensure the spreader bar is not tied over the anchor line.

TRANSITION: Are there any questions over the construction of the A-Frame? If there are no questions, we'll go over how to gain height using a tree branch.

**PRACTICE** (CONC)

- a. Students will construct an A-frame.

**PROVIDE HELP** (CONC)

- a. The instructors will assist the students when necessary.

**OPPORTUNITY FOR QUESTIONS** (3 Min)

**1. QUESTIONS FROM THE CLASS**

**2. QUESTIONS TO THE CLASS**

**Q.** What is the definition of an A-Frame?

**R.** It is an artificial device used to gain height in rope installations.

**S.** What are the materials required to construct an A-Frame?

- A.** (1) Two poles approximately 8 feet long and not less than 3 inches in diameter.  
(2) 4-6 sling ropes.

**SUMMARY** (2 Min)

- a. During this period of instruction we have discussed the materials needed to construct an A-Frame and the actual techniques involved in the construction of an A-Frame.
- b. Those of you with IRF's please fill them out at this time and turn them in to the instructor. We will now take a short break.

**UNITED STATES MARINE CORPS**  
Mountain Warfare Training Center  
Bridgeport, California 93517-5001

SML  
SMO  
ACC  
02/11/02

**LESSON PLAN**

**VERTICAL HAULING LINES**

**INTRODUCTION**

(5 Min)

- 1. GAIN ATTENTION.** In mountain operations it is often necessary to move inexperienced troops and equipment over steep, rocky terrain. A fixed installation is one method to move personnel up or down these obstacles. However, this method is not always sufficient for moving their equipment. So, the construction of a vertical hauling line system may be necessary.
- 2. OVERVIEW.** The purpose of this period of instruction is to provide the student with the necessary information to establish vertical hauling lines for use in evacuating patients and moving gear up and down steep cliffs. This will be accomplished by discussing the definitions, purposes, criteria of site, and usage of this system. This lesson relates to cliff assault.

**INSTRUCTOR NOTE:** Have students read learning objectives.

**3. INTRODUCE LEARNING OBJECTIVES**

- a. TERMINAL LEARNING OBJECTIVES.** In a mountainous environment, establish a vertical hauling line, in accordance with the references.
- b. ENABLING LEARNING OBJECTIVES.**
  - 1. )** Without the aid of references, describe in writing the purpose of a vertical hauling line, in accordance with the references.
  - 2. )** Without the aid of references, list in writing the criteria involved in site selection for a vertical hauling line system, in accordance with the references.
  - 3. )** In a summer mountainous environment, construct an endless rope for use in a vertical hauling line system, in accordance with the references.

**4. METHOD/MEDIA.** The material in this lesson will be presented by lecture and demonstration. You will practice what you have learned during upcoming field training exercises. Those of you with IRF's please fill them out at the end of this period of instruction

**5. EVALUATION.**

- a. MLC - You will be evaluated later in this course by written and performance examination.

TRANSITION: Are there any questions over the purpose, learning objectives, how the class will be taught, or how you will be evaluated? We will start by discussing the vertical hauling line.

**BODY**

(45 Min)

**1. (5 Min) VERTICAL HAULING LINE**

- a. Purpose. The purpose of a vertical hauling line is to move equipment and troops over steep, rocky terrain.
- b. Materials. The materials needed for a vertical hauling line are:
  - 1 ) Two static ropes. (An additional rope is required if using a knotted hand line)
  - 2 ) Minimum of six sling ropes.
  - 3 ) Four steel locking carabiners.
  - 4 ) An appropriate belay device. (four non-locks if using a crab brake)
  - 5 ) Two rescue pulleys. (Optional - these are preferred but locking carabiners may be used.)
  - 6 ) Two A-Frame poles, strong enough to support the load and tall enough to provide adequate clearance for the load.

TRANSITION: We have covered what the vertical hauling is, are there any questions? Without a proper site, building any installation in the mountains could be useless, as well as dangerous.

**2. (2 Min) SITE SELECTION FOR A VERTICAL HAULING LINE.** Picking the proper site is critical to the safe and efficient operation of a vertical hauling line. The site must meet the following four criteria:

- a. It must have a suitable top anchor.
- b. It must have good loading and unloading platforms.
- c. There must be sufficient clearance for the load at all points.



- d. If using an A-Frame, you must be able to anchor the butt ends of the A-Frame.

TRANSITION: Now that we have discussed what is required for site selection, are there any questions? Let's take a look at the construction of a vertical hauling line using an A-Frame.

**3. (15 Min) CONSTRUCTION OF A VERTICAL HAULING LINE USING AN A-FRAME**

- a. Construct an A-Frame that can support the load to be moved and that provides adequate clearance.
- b. To anchor the A-Frame, use the following procedures. One static rope will be used.
  - 1 ) Double the rope and find the middle.
  - 2 ) Lay the middle of the static rope over the apex of the A-Frame, leaving an 18 inch bight over the apex. This is known as the anchor bight.
  - 3 ) Tie clove hitches above the lashing on each side of the apex, ensuring that the clove hitch locking bars are facing each other and are next to the lashing. The 18 inch bight is left dangling from the top of the apex.
  - 4 ) Anchor the A-Frame, using a round turn and, two half hitches. Angle the A-Frame 30 degrees from the vertical and tie off using two half hitches. The rest of the rope is coiled neatly and placed out of the way.
  - 5 ) Construct a second 18 inch bight from the top of the apex using a sling rope. This is known as the safety bight. Attach the sling rope to each side of the apex of the A-Frame above the first clove hitches the same manner as the anchor bight with the locking bars to the outside. Adjust the spacing between the anchor bight and safety bight to 1-3 inches (2-4 fingers). Secure the pigtails of the sling rope with a square SAFETY BIGHT knot and two overhands at the rear of the apex of the A-Frame.
  - 6 ) Two steel locking carabiners with gates opposite and opposed are inserted into both bights hanging down from the apex.
- c. Hauling Line. A hauling line is constructed next. Hauling lines can be constructed in two different ways. Either by using the end of the rope or securing it to itself making an endless rope.
  - 1 ) For lowering and raising heavy loads and personnel; the end of the rope is used. (This method is less efficient but much safer than the endless rope) It is constructed by running one end of the rope through the carabiners/pulleys on the safety/anchor bight and tying a figure 8. The other end is then incorporated with an anchor (i.e. tree wrap) and an

appropriate lowering/raising system discussed later.

- 2 ) If the hauling line is to be controlled from the bottom of the cliff, it is converted into an endless rope by tying the two ends together using a square knot finished with two overhand knots. Next, two directional figure-of-eight knots are tied on opposite sides of the rope, one at each loading/unloading platform.

#### ENDLESS LOOP

- 3 ) After completing the hauling line, personnel at the base of the cliff should pull on the line to test it and the A-Frame.

#### **d.** Additional Considerations

- 1 ) Eliminate excessive friction. Use pulleys when possible.
- 2 ) To help keep the line taut and the load from banging into the cliff, tie a swami wrap on a tree with a carabiner and pulley on it. Run the endless rope through the pulley and tighten the joining knot on the endless rope. This will minimize the mule team size and make it easier to move the loads up and down.
- 3 ) Remove any obstacles and any loose objects, which could be dislodged by men or equipment.
- 4 ) Station two men at the unloading platform to operate the A-Frame during use. These operators are tied in with a safety line.
- 5 ) Use multiple anchors when establishing an A-Frame/vertical hauling line. This will prevent total system failure should one particular anchor fail.
- 6 ) A knotted handline may be used to aid individuals up a vertical hauling line and is constructed as follows: Overhand knots are placed approximately 10-12 inches apart, ensuring that there is approximately 20 feet without knots at one end to be used to anchor. To anchor the handline, tie a round turn and a bowline finished with an overhand, around the anchor and throw the knotted handline over the apex of the A-Frame. The knotted handline is used as a simple fixed rope by any personnel ascending the vertical hauling line.

#### KNOTTED HANDLINE

TRANSITION: Are there any questions over the A-frame construction? We will now discuss how to gain height using a tree.

4. (5 Min) **USING A TREE TO GAIN HEIGHT.** When using a tree to gain height in a vertical hauling line installation; there are some considerations that need to be applied. The

following factors are to be considered:

- a. Select a branch that has not been chopped, burned or is rotten.
- b. The branch must be at least 6” in diameter or of suitable thickness to support the intended load.
- c. The branch should be at a sufficient height to offer adequate clearance for the load.
- d. A loose swammi wrap will be tied around the intended branch.
- e. Two steel locking carabiners with gates opposite and opposed are inserted into the swammi wrap.

#### USING A TREE TO GAIN HEIGHT

- f. The desired rope installation will be attached through the carabiners.

TRANSITION: Are there any questions over the construction using a tree? If not, we will now learn how to operate a vertical hauling line.

#### **5.** (3 Min) OPERATION OF THE VERTICAL HAULING LINE

- a. Personnel or equipment are secured to the hauling line and raised or lowered by a team of Marines pulling on the rope, or belaying it down.
  - 1 )If equipment and personnel are only being lowered, the hauling line can be used from the top with the same belay used with the *SUSPENSION TRAVERSE*.
  - 2 )If equipment is being raised from the bottom, an endless rope is the most efficient hauling line.
  - 3 )Marines and equipment being raised or lowered will load and unload through the center of the A-Frame, not to the sides.
  - 4 )Mule Team. If equipment and personnel can be raised from the top of the cliff, a mule team can be used there. To establish a mule team, the hauling line is run through a pulley or carabiner (preferably a pulley) at the anchor point behind the system. The line is then led away at about a 90-degree angle to a cleared area. A safety line should be attached to the hauling line to prevent the load from falling if the hauling line is dropped by the mule team. This is done with an autoblock/French prusik on the carabiner or pulley on the anchor. A group of six men, (mule team) assemble on this rope on the side of the rope away from the cliff or outside the bight of the rope if on the bottom. They will haul personnel and supplies up the cliff by grasping the rope and simply walking away with it. One man monitors the auto block to ensure it does

not run through the 85 carabiner (He will not wear gloves). If the mule team loses control of the line the safety man will let go of the autoblock. The mule team responds to a single commander by using the following verbal/hand and arm signals.

**6. (5 Min) CONSTRUCTION AND OPERATION OF A BRAKING/BELAY DEVICE**

**a.** Because the A-Frame/vertical hauling line can be a very strong, sturdy system, we often put heavy loads on it. When working with heavy loads, a braking/belay device that generates a great deal of friction is required. The most commonly used device for this purpose is the Carabiner Brake or Crab. The equipment needed is as follows:

**1** ) Four steel locking 82's or aluminum non-lock carabiners.

**2** ) One steel locking carabiner (large D).

**b.** Construction.

**1** ) Insert one large steel carabiner into the anchor with the gate up.

**2** ) Insert two small carabiners with gates facing to the right into the one large steel locking carabiners.

**3** ) Pull up a bight of rope and insert it through the two small carabiners.

**4** ) Clip two more small carabiners with the gate facing down and to the right into and through the first two small carabiners.

**NOTE:** All directions apply while facing the anchor.

**c.** Operation.

**1** ) More than one rope may be fed through the double crab.

**2** ) As the rope flows through the crab brake, make sure that the direction of the rope (if coming in contact with the gates of the locking carabiners) is such that the rope is tightening the gates.

**3** ) The flow of the rope through the crab brake should be constant and smooth.

**4** ) Regardless of the type of belay device, two Marines will be required in lowering. One to operate the belay device (i.e. crab brake) and one to monitor the safety prusik.

**NOTE:** The double carabiner brake/double crab is a one way brake used for lowering only and cannot be reversed under a load.

TRANSITION: Now that we have covered the operation, are there any questions? If there are none for me, then I have some for you.

## **PRACTICE**

(CONC)

- a.** Students will construct an A-frame and vertical hauling line and operate a vertical hauling line.

## **PROVIDE HELP**

(CONC)

- a.** The instructors will assist the students when necessary.

## **OPPORTUNITY FOR QUESTIONS**

(3 Min)

### **1. QUESTIONS FROM THE CLASS**

### **2. QUESTIONS TO THE CLASS**

What is the purpose of a vertical hauling line?

A. The purpose of a vertical hauling line is to move equipment and troops over steep, rocky terrain.

**Q.** What are the four criteria for site-selection for a vertical hauling line?

- A.** (1) Suitable to anchor.
- (2) Good loading and unloading platform.
- (3) Sufficient clearance for the load.
- (4) Butt ends of the A-Frame must be anchored.

## **SUMMARY**

(2 Min)

- a.** During this period of instruction we have discussed the materials needed to construct a vertical hauling line with an A-frame and the actual techniques involved in the construction of an A-frame and a vertical hauling line.
- b.** Those of you with IRF's please fill them out at this time and turn them in to the instructor. We will now take a short break.

UNITED STATES MARINE CORPS  
Mountain Warfare Training Center  
Bridgeport, California 93517-5001

SML

SMO

ACC  
02/11/02

**LESSON PLAN**

**SUSPENSION TRAVERSE**

**INTRODUCTION**

(5 Min)

- 1. GAIN ATTENTION.** If we had to move personnel and equipment over ravines, rivers, and chasms and up or down cliffs, we would have a major difficulty with the task. One of the simplest methods of making the task easier is to use a suspension traverse. This is basically a line of non stretch rope placed from one point to another, which men and equipment can be moved up or down any obstacle, with the only limiting factors being the length of the rope. This class will provide your unit with the knowledge to build a suspension traverse.
- 2. OVERVIEW.** The purpose of this period of instruction is to introduce the students to the method of erecting, and operating a suspension traverse. This lesson relates to cliff assaults.

**INSTRUCTOR NOTE:** Have students read learning objectives.

**3. INTRODUCE LEARNING OBJECTIVES**

**a. TERMINAL LEARNING OBJECTIVE.** In a summer mountainous environment, conduct a suspension traverse as a member of a squad, in accordance with the reference.

**b. ENABLING LEARNING OBJECTIVES.** (MLC) and (ACC)

**1 )** Without the aid of references, list in writing the considerations when selecting a site to establish a suspension traverse, in accordance with the reference.

**2 )** Without the aid of references, construct a suspension traverse utilizing an A-frame, in a specified time limit and in accordance with the references.

**3 )** In a summer mountainous environment, construct a belay line, in accordance with the references.

4 ) Without the aid of references and given a list of the hand and arm signals, demonstrate the hand and arm signals for operating a suspension traverse, in accordance with the references.

**c. ENABLING LEARNING OBJECTIVES. (SMO).**

1 ) With the aid of references, state orally the considerations when selecting a site to establish a suspension traverse, in accordance with the reference.

2 ) In a summer mountainous environment, construct a belay line, in accordance with the references.

3 ) With the aid of references and given a hand and arm signal, state orally the proper commands, in accordance with the references.

4. **METHOD/MEDIA.** The material in this lesson will be presented by lecture and demonstration. You will practice what you have learned in upcoming field exercises. Those of you with IRF's please fill them out at the conclusion of this period of instruction.

**5. EVALUATION**

a. MLC - You will be tested later in the course by written and performance evaluations on this period of instruction.

b. SMO - You will be tested by a verbal and performance test.

TRANSITION: Are there any questions over the purpose, learning objectives, how the class will be taught, or how you will be evaluated? Let us now discuss the definition of a Suspension Traverse.

**BODY**

(70 Min)

1. (5 Min) **DEFINITION.** A suspension traverse is a high- tension rope installation established at a suitable angle (not less than 30 degrees and not more than 65 degrees approximately) which allows a suspended load (no more than 250 lb. is recommended) to be moved over cliffs, ravines and rivers.

**NOTE:** The limit of 250 lb. has been recommended not because the suspension traverse would fail, but it is about the limit that can be safely manhandled next to a cliff edge.

TRANSITION: Are there any questions over the definition? Let us discuss the selection of a site for a suspension traverse.

2. (5 Min) **SITE SELECTION.** The three considerations for site selection for a suspension traverse are:

- a. Suitable upper and lower anchors must be available.
- b. Good loading and unloading platforms.
- c. Sufficient clearance for the load.

TRANSITION: Now that we have covered where to establish the suspension traverse, are there any questions? Let's look at the construction.

**3. (10 Min) CONSTRUCTION OF A SUSPENSION TRAVERSE.**

**a. Top to Bottom.**

- 1 ) When constructing the suspension traverse from top to bottom, a suitable high-tension anchor system will be placed around the top anchor point.
- 2 ) The rope will be deployed and the construction/mule team will rappel down in order to construct the bottom anchor.
- 3 ) Select a sound bottom anchor point and construct a suitable high-tension anchor system.
- 4 ) The rope is pulled to the bottom anchor and clipped through the anchor system's 85.
- 5 ) With an 18" Prusik Cord, tie a French Prusik to the rope and secure it also to the anchor system's 85. This will serve as the brake.
- 6 ) On the rope running from the far anchor point, tie a friction knot and attach an 85 through its loops. Clip the running end of the rope to the 85.
- 7 ) Attach a second 85 into the anchor system and clip the running end of the rope into it.
- 8 ) Where the rope comes out from the friction knot's 85, tie a second friction knot complete with an 85 and clip the running end of the rope through it.
- 9 ) You have now made a 9:1 mechanical advantage system, with a brake attached.

**NOTE**: If pulleys are available, place them in the 85 carabiner on the friction knot.

**b. Tensioning the installation.**

- 1 ) Initially the traverse is tensioned by one man. This is accomplished by pulling on the 9:1, the French Prusik is used to hold the tensioned line when the friction knots are moved.
- 2 ) When the installation has been tensioned as much as possible, it is secured by taking the standing end around the anchor point and pulling a large bight through the anchor



system's 85.

- 3 ) Still maintaining tension on the installation, tie the bight off with a round turn and two half hitches.

**SAFETY NOTE:** NO MORE THAN TWO MEN WILL TENSION THE INSTALLATION AT ANY TIME IF USING PULLEYS.

**NOTE:** When two ropes are used, care should be taken to anchor the lines as close together as possible, in such a manner that the ropes do not cross each other.

**c.** Bottom to Top.

- 1 ) When constructing a suspension traverse from bottom to top, the lead climber will attach the traverse's ropes to the back of his harness.
- 2 ) Once the lead climber reaches the top safely, the traverse's ropes will be anchored off using a suitable high-tension anchor system. The lead climber will then bring up the number 2 climber.
- 3 ) The installation is constructed and tightened from the bottom.

**TRANSITION:** Now that we have discussed the construction, are there any questions? If you have to gain height at the top and there is no suitable tree, branch, or rock to place the static line across then you will have to construct and use an A-frame (see A-Frame outline).

**4.** (5 Min) USE OF AN A-FRAME.

- a.** Bringing up A-frame poles. If you have to gain artificial height at the top and there is no suitable tree branch/rock etc., then the A-frame logs, sling ropes and carabiners need to be moved to the top of the cliff. This can be accomplished in the following manner:

- 1 ) The A-frame logs are tied to the ropes utilizing the Timber Hitch (See ROPE MANAGEMENT). The extra sling ropes and carabiners are clipped into the rope.
- 2 ) The climbers will haul the logs to the top and construct their portion of the installation.

**NOTE:** The A-frame is constructed in the same manner as taught in A-FRAMES. The suspension traverse rope is located in the upper V (apex) of the A-frame. The A-frame can be placed under the static rope before or after the rope is tensioned. The latter way is better on a long suspension traverse as it helps tension the rope further.

**b.** Securing the A-Frame.

- 1 ) An over the object clove hitch is tied in the middle of a sling rope and placed over

one pole at the apex.

- 2 ) A prusik is tied around the suspension traverse lines with the ends of the sling rope on both sides of the A-frame. This is done before erecting the A-frame.
- 3 ) The butt ends must be anchored using a practice coil.
- 4 ) The ropes should be buffed wherever necessary.

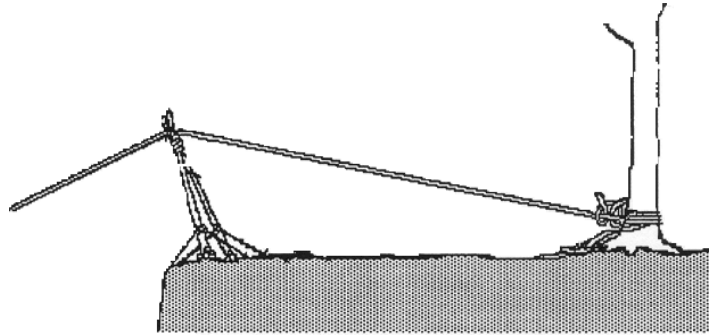

#### SECURING THE A-FRAME

**NOTE:** As you can see from the figure above, the A-frame should be inclined forward on the edge of the cliff face, this is done to offset the strain on the A-frame to stop it from collapsing forwards or backwards. The approximate angle is between 45-60 degrees.

**TRANSITION:** Now that we have discussed use of an A-Frame, are there any questions? Let us now discuss the use of a tree to gain height.

5. (5 Min) **USING A TREE TO GAIN HEIGHT.** When using a tree to gain height in a suspension traverse rope installation; there are some considerations that need to be applied. The following factors are to be considered:
  - a. Select a branch that has not been chopped, burned or is rotten.
  - b. The branch must be at least 6" in diameter or of suitable thickness to support the intended load.
  - c. The branch should be at a sufficient height to offer adequate clearance for the load.
  - d. A suitable anchor point must be located behind the intended branch and in relation to the direction of pull of the load.

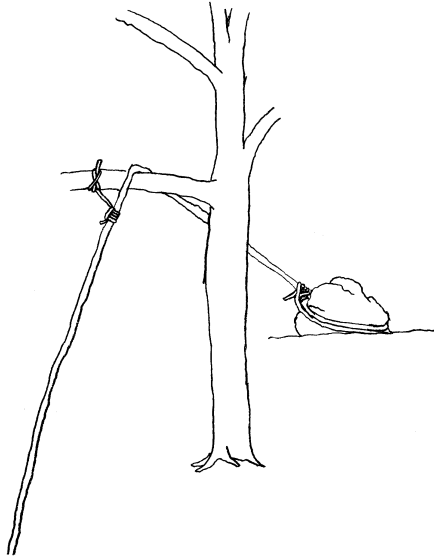

#### **USING A TREE TO GAIN HEIGHT**

- e. To secure the rope in place over the branch, use a sling rope and tie a clove hitch around the branch. Secure the pigtail of the sling rope to the rope installation by tying end of the line prusiks. This will prevent the rope from rubbing side to side and also function as the third leg.

**TRANSITION:** Are there any questions regarding the use of a tree to gain height? If not, let's talk about the use of personnel.

- 6. (5 Min) **USING PERSONNEL TO GAIN HEIGHT.** If there is no reasonable object available to gain height, personnel may have to manhandle the equipment over the edge. The following factors are to be considered:

- a. The edge of the obstacle must be buffed to prevent unnecessary abrasion to the ropes.
- b. The weight of the load must not exceed 100 lbs.
- c. The personnel handling the load must be secured to the cliff with a safety line.

**TRANSITION:** Are there any questions over the use of personnel? Let's discuss the technique used to attach loads to the static line.

- 7. (10 Min) **CONSTRUCTION OF THE BELAY LINE.** The belay rope is used to attach personnel and equipment to the bridging line and belay system. It is tied as follows:

- a. Ensure that the belay line is established at the top of the bridge with an adequate anchor, braking system, and a safety prusik.
- b. Tie a figure eight loop at the end of the belay line, and attach it with a carabiner to the load.

- c. Twelve to eighteen inches from the end of the belay line tie another figure eight loop and attach this loop to the bridging line with a carabiner.

#### SUSPENSION TRAVERSE BELAY LINE

- d. Using web runners and aluminum carabiners girth hitch the web runners to the belay line, and clip into the bridging line at intervals of approximately 15 feet. This is to ensure that the belay line doesn't sag excessively and tangle in trees or on rocks.

TRANSITION: Are there any questions over the construction of the belay line? When lowering gear, a belay system must be used. The Marine assigned as the belay man plays a very important role. Let us now discuss the operation of the suspension traverse.

- 8. (10 Min) **OPERATION OF A SUSPENSION TRAVERSE.** A suspension traverse is used for the transportation of men and equipment up and down a vertical obstacle. The operating procedure is as follows:

- a. **Point NCOIC.** The Point NCOIC has overall responsibilities for the operation of the suspension traverse. The Point NCOIC duties include:

- 1 ) Supervision of the construction of the installation.

- 2 ) Control of the load being lowered and raised.

- 3 ) Deploys web runners on the belay line.

- 4 ) Ensure that the brakes are employed properly.

- 5 ) In command of the mule team.

- b. **Lowering.** Whenever a load is lowered down a suspension traverse, a belayer and a belay line are used to control the load. Ideally the belay man should observe the load being lowered. If this isn't possible, the belay man will receive his commands from the Point NCOIC.

- 1 ) **Carabiner Brake.**

- a) To make the single carabiner brake, two small carabiners are hooked to the anchor point, opposite and opposed. Two more carabiners are locked, gates to the right, to the first set. The last sets of carabiners are placed across the body of the second set, gates down and right.

## CARABINER BRAKE

- b**) If the gates were against the ropes, the rope action would in time unlock the carabiners, with dangerous consequences (if using locking ovals).
- c**) To place tension or brake the rope, the belay man simply pulls the rope against the carabiners, towards the load, which creates more friction on the rope.
- d**) The carabiner brake is a good method for lowering a load due to lots of friction and good control, but the carabiner brake does not make for a good raising system because of the large amount of friction. This will make unnecessary work for the mule team.

**NOTE:** If the loads require more or less friction, you can add or take away the carabiners, which are placed across the body.

SMO CUE: TC 8

**2**) Figure 8. The Figure 8 rappel device is the easiest method for belaying a load.

- a**) Thread a bight of the belay line through the large "O" ring and pull it over the small "O".
- b**) Clip a locking carabiner through the small "O" ring and attach it to an anchor point.
- c**) Braking is conducted in the same fashion as in rappelling.

### OPERATION OF THE FIGURE 8

**3**) Munter Hitch. The Munter Hitch is a good brake because of the minimal gear required. Use with heavy loads.

**4**) Stitch Plate. The stitch plate is a user-friendly device that offers quick attachment and removal. Unlike some other belay techniques, the stitch plate has no rope on rope friction. This system can be used for all load sizes.

### OPERATION OF THE STITCH PLATE

**5**) Safety Brake. For added security, an end of the line friction knot is attached to the belay line in the front of the braking device. The safety brake will have its own anchor point. One man is tasked with the operation of the safety brake.

- c.** Raising the load. If a large amount of heavy weapons, ammunition, or other logistical equipment is to be moved over an obstacle, a suspension traverse is the most expedient method we can use. Because part of the weight of the supplies to be lifted will be carried by the static line. This is not true in a vertical hauling line where all the weight is suspended vertically. The main method of raising supplies is by utilizing a "Mule Team". This is a group of men 6 or more who will do the lifting.

## 1 ) Mule Team.

- a) To establish a mule team, the belay/haul line is run through a pulley or a steel locking carabiner at the top of the system, just as for lowering.

**NOTE:** This is why choosing a belay device that is suitable for the load and can be removed quickly is so important.

- b) If the cliff head does not afford an open area for the mule team to operate directly back, the haul/belay line can be re-directed. The line is then led away at an angle to a cleared area.
- c) Six or more men assemble on the rope, on the side away from the cliff. They will haul supplies and personnel up the cliff by grasping the rope and simply walking with it. This uses leg muscles and can be maintained for long periods of time. The mule team responds to a single commander by using the following verbal/hand and arm signals:

\* The rope should be held unless specifically ordered to lay it down. Also the use of the prusik braking system on the belay rope is necessary, in the event that the mule team lose control of the rope.

\* As with all installations requiring commands, some form of tactical commands need to be established. Those can be established by unit SOP.

**TRANSITION:** Now that we have discussed the commands, are there any questions? We will now discuss load considerations.

**9.** (5 Min) **GENERAL LOAD CONSIDERATIONS.** The type of equipment that needs to be lowered or raised will range from weapons to ammunition, personnel to litters, all of which need to be handled differently.

- a. **Weapons.** Normally the types of weapons that would have to be raised or lowered are the crew served weapons organic to a rifle battalion, i.e. 81mm Mortar, 50 caliber machine gun, dragon etc. The basic method of securing these weapons is accomplished by using two sling ropes and tying a clove hitch to the front and rear of the weapon. A figure of eight is then tied into the ends and attached to the suspension traverse. The belay line is now attached to the load.

**b.** Ammunition/Equipment. The articles to be moved are to be secured through bundling or banding them together. A rope is then taken and tied around the equipment in a package\_wrap fashion. The rope is wrapped one time around the bundle, then when the rope is brought back together; the ends will be crossed and wrapped around the remainder of the bundle (90 degrees to the previous wrap). This is then secured by using a square knot with two over hands and attached to the carrier rope by a steel locking carabiner.

**c.** Litters. The two standard litter types used are the collapsible and the stokes. These litters are to be rigged for a medevac as per MOUNTAIN CASUALTY EVACUATION. The litter to be used will be attached to the Suspension Traverse as follows:

**1** ) To attach the belay line to the litter you tie a figure of eight loop at the end of the belay line, then attach it to the lower body pre-rigs. Then tie a second figure of eight loop approximately four to five feet from the first figure eight loop, and attach it to the upper body pre-rigs.

**NOTE:** Make sure that when you are doing this, that you are at a safe distance from the edge of the cliff head, and the brakeman is on belay.

**2** ) At this stage it is worth checking and adjusting the length of the pre-rigs, to ensure that the casualty's head is higher than his feet. Once all that is done and checked, the belay line is taken tight and the litter is attached to the suspension traverse, the lower body carabiner is attached first, followed by the upper body carabiner. This is awkward to do. The helpers must have a safety line on while moving around at the cliff head.

**3** ) Before you start to lower, a last minute safety check is essential to ensure that carabiners are locked, knots are secure, casualty is secure, that the brake man is on the brake and the safety man is manning the prusik. Now you can commence lowering or raising the casualty.

**d.** Personnel. Personnel will wear a rappel seat clipped into the belay line.

TRANSITION: Are there any questions about load considerations? If there are none for me, then I have some questions for you.

### **PRACTICE**

(CONC)

**a.** Students will construct and operate a suspension traverse.

### **PROVIDE HELP**

(CONC)

**a.** The instructors will assist the students when necessary.

## **OPPORTUNITY FOR QUESTIONS**

(3 Min)

### **1. QUESTIONS FROM THE CLASS**

### **2. QUESTIONS TO THE CLASS**

**Q.** What are the three considerations in selecting a site for a suspension traverse?

- A. (1) Good upper and lower anchors.  
(2) Good loading and unloading platforms.  
(3) Sufficient clearance for the load.

**Q.** What are the commands given between the belay man and the individual going down a suspension traverse?

- A. (1) Last name, on suspension traverse!  
(2) Last name, on belay!  
(3) Slack.  
(4) Tension.  
(5) Last name, off suspension traverse!  
(6) Last name, off belay!

**Q.** What are the five hand and arm signals used when using a mule team?

- R.** (1) Pickup the rope.  
2 ) Take the strain.  
3 ) Walk away.  
4 ) Check.  
5 ) Walk toward.

## **SUMMARY**

(2 Min)

- a.** During this period of instruction, we have covered the correct selection of a site and the equipment needed for a suspension traverse, techniques for construction, lowering and raising loads, commands used for these operations, and general considerations.
- b.** Those of you with IRF's please fill them out at this time. We will now take a short break.



**UNITED STATES MARINE CORPS**  
Mountain Warfare Training Center  
Bridgeport, California 93517-5001

SML  
SMO  
ACC  
02/11/02

**LESSON PLAN**

**RAPPELLING**

**INTRODUCTION**

(5 Min)

**1. GAIN ATTENTION.** Rappelling is a method for descending vertical or near vertical cliffs. It will enable your unit to move quickly over rugged terrain to swiftly accomplish its mission. Learning how to establish a rappel site and then applying it is an essential skill that all Marine units should possess while operating in a mountainous environment.

**2. OVERVIEW.** The purpose of this period of instruction is to introduce the students to rappelling by discussing the dangers, site selection considerations, commands involved in rappelling, and the different types of rappels. This lesson relates to cliff assault.

**3. INTRODUCE LEARNING OBJECTIVES.**

**a. TERMINAL LEARNING OBJECTIVES.** In a summer mountainous environment and given a designated cliff face, conduct rappelling operations, in accordance with the references.

**b. ENABLING LEARNING OBJECTIVES.** (SML) and (ACC)

**1 )** Without the aid of references, list in writing the criteria involved in site selection for a rappel site, in accordance with the references.

**2 )** Without the aid of references, list in writing the duties of the rappel point NCOIC, in accordance with the references.

**3 )** Without the aid of references, describe in writing the types of rappels, in accordance with the references.

**4 )** In a summer mountainous environment, rappel down a moderate slope using a hasty rappel, in accordance with the references.

**5 )** In a summer mountainous environment, execute a seat-shoulder rappel, in accordance

with the references.

6 ) In a summer mountainous environment, rappel down a cliff face at night using a seat-hip rappel, in accordance with the references.

7 ) Without the aid of references, list in writing the duties of the first man down a rappel lane, in accordance with the references.

8 ) Without the aid of references, execute the commands used between a rappeller and his belay man when conducting a rappel, in accordance with the references.

9 ) In a summer mountainous environment, tie off on a cliff face while conducting a seat-hip rappel, in accordance with the references.

(10) In a summer mountainous environment, retrieve a rappel rope, in accordance with the references.

**c. ENABLING LEARNING OBJECTIVES. (SMO)**

1 ) With the aid of references, state orally the criteria involved in site selection for a rappel site, in accordance with the references.

2 ) With the aid of references, state orally the duties of the rappel point NCOIC, in accordance with the references.

3 ) With the aid of references, describe orally the different types of rappels, in accordance with the references.

4 ) In a summer mountainous environment, rappel down a moderate slope using a hasty rappel, in accordance with the references.

5 ) In a summer mountainous environment, execute a seat-shoulder rappel, in accordance with the references.

6 ) In a summer mountainous environment, rappel down a cliff face at night using a seat-hip rappel, in accordance with the references.

7 ) With the aid of references, state orally the duties of the first man down a rappel rope, in accordance with the references.

8 ) With the aid of references, execute the commands used between a rappeller and his belay man when conducting a rappel, in accordance with the references.

9 ) In a summer mountainous environment, tie off on a cliff face while conducting a seat-hip rappel, in accordance with the references.

(10) In a summer mountainous environment, retrieve a rappel rope, in accordance with

the references.

**4. METHOD/MEDIA.** The material in this lesson will be presented by lecture and demonstration. You will practice what you have learned in upcoming field training exercises. Those of you with IRF's please fill them out at the end of the period of instruction.

**5. EVALUATION.**

- a. MLC - You will be tested later in the course by written and performance evaluations on this period of instruction.
- b. ACC - You will be tested later in the course by written on this period of instruction and by performance evaluations during the cliff assault.
- c. SMO - You will be tested by a verbal and performance evaluation on T- 11.

**TRANSITION:** Are there any questions over the purpose, learning objectives, how the class will be taught, or how you will be evaluated? First, let's discuss why rappelling is dangerous and site selection.

**BODY**

(90 Min)

**1. (2 Min) INHERENT DANGER OF RAPPELLING.** Rappelling is inherently dangerous because rappellers rely totally on the equipment.

- a. To ensure a safe training evolution, two ropes will be utilized at MWTC.
- b. All the rappels taught at MWTC can be completed with a single rope if the situation arises.
- c. If utilizing a one-rope system with the carabiner wrap, the rope will be attached to the carabiner with two wraps vice one.

**TRANSITION:** Are there any questions over the inherent dangers of rappelling? If not, let's discuss the criteria's involved in site selection.

**2. (5 Min) SITE SELECTION.** When selecting a rappel site consider these three factors.

- a. There must be a good anchor. As previously taught in *NATURAL* and *ARTIFICIAL ANCHORS*, natural anchors are preferred.
- b. The rappel route down should be as free of obstacles (i.e., vegetation, debris) as possible.
- c. There must be suitable loading and unloading platforms.

**NOTE:** The evaluation of a site for the above factors should be made by the rappel point

NCOIC, who should be the most experienced rappeller in the unit.

TRANSITION: Are there any questions over site selection? Once an area has been found that meets these requirements, a rappel site may now be established. Let us now talk about duties of the rappel point NCOIC.

**3.** (10 Min) **DUTIES OF THE RAPPEL POINT NCOIC**. Once a rappelling site has been selected, one person will be appointed to each rappel lane as a rappel point NCOIC. These individuals should have experience as rappellers. The rappel point NCOIC has ten duties and responsibilities, which are:

- a. Ensures that the anchor points are sound and that the knots are properly tied.
- b. Ensures that loose rock and debris is cleared from the loading platform.
- c. Allows only one man on the loading platform at a time and ensures that the rappel point is run in an orderly manner.
- d. Ensures that each man is properly prepared for the particular rappel; i.e. gloves on, sleeves down, helmet secured, rappel seat tied correctly and secured properly.
- e. Attaches the rappeller to the rope and ensures the rappeller knows the proper braking position for that particular rappel.
- f. Ensures that the proper commands or signals are used.
- g. Dispatches each man down the rope.
- h. The rappel point NCOIC will be the last man down the rope.
- i. The rappel point NCOIC will ensure that the ropes are inspected after every 50 rappels.
- j. The rappel point NCOIC will maintain a rope log.

TRANSITION: Before we go any further are there any questions over the duties of the rappel point NCOIC? We will now discuss the different types of rappels taught here at MWTC.

**4.** (5 Min) **TYPES/USE**. The three types of rappels and when they are preferred to be used are:

- a. Hasty Rappel. It is used when carrying loads down moderate slopes.
- b. Seat-Shoulder Rappel. It is used for heavily laden troops over vertical to near vertical cliff faces.
- c. Seat-Hip Rappel. It is used when carrying loads over vertical to near vertical faces.

TRANSITION: Are there any questions on the different types of rappels? Next we will discuss

how each of these rappels are used.

**5.** (5 Min) **HASTY RAPPEL.** The hasty rappel is the easiest type of rappel to prepare for. It requires no equipment other than a rope and gloves.

**a.** Conduct. A hasty rappel is conducted in the following manner:

**1** ) Sleeves will be rolled down and gloves will be put on.

**2** ) Face slightly sideways.

**3** ) Place the rappel rope across your back, grasping it with both hands, palms forward, and arms extended.

**4** ) The hand nearest the anchor is the guide hand. The hand farthest from the anchor is the brake hand.

**5** ) Lean out at a moderate angle to the slope.

**6** ) Descend down the hill facing half sideways, taking small steps and continually looking downhill while leading with the brake hand.

**7** ) Feet should not cross and the downhill foot should lead at all times.

**b.** Braking. The steps for braking during a hasty rappel are as follows:

**1** ) Bring the lower (brake) hand across the front of the chest to brake.

**2** ) At the same time, turn to face up toward the anchor point.



#### **HASTY RAPPEL**

TRANSITION: Are there any questions about the technique of the hasty rappel? Now let us discuss the seat-shoulder rappel.

**6.** (5 Min) **SEAT-SHOULDER RAPPEL.** The seat-shoulder rappel relies on friction as the main effort of controlling the descent. It is very efficient for men with heavy packs because it provides support for heavy loads on the back.

**a.** Conduct. A seat-shoulder rappel is conducted in the following manner:

**1**) Put on your rappel-seat, roll down your sleeves and put on your gloves.

**NOTE:** To avoid causing a possible injury, it is advised that the rappel seat be constructed at the rear of the rappel site loading platform. If the rappel seat is worn for too long, the rappel seat could loosen up enough to cause you to slip out of your seat while rappelling.

**2**) The steel locking carabiner is placed on the rappel-seat so that the gate opens down and away, to prevent the gate from opening once the wraps are placed into the carabiner.

**3**) Step-up to the rope with your left shoulder facing the anchor.

**4**) The rappel rope is attached to the rappeller's hard point carabiner as follows:

**a)** Snap the rope into the locking carabiner.

**b**) Taking slack from the standing (anchor) end of the rope, make one wrap with the rope around the body of the carabiner and back through the gate.

**c)** Ensure that the locking nut of the carabiner is fastened to lock the carabiner closed.

**NOTE:** If you are using only one rope to rappel with due to the tactical situation or equipment availability, the procedures are the same, EXCEPT the individual will make two wraps around the body of the carabiner instead of one.

**5**) Take the rope across your chest, over your left shoulder, diagonally across your pack and down to the right (brake) hand.

**6**) Descend by walking down the cliff using the braking procedure to control the rate of descent. Look under your brake arm for possible obstacles to avoid.

**b.** Braking. The steps for braking during a seat-shoulder rappel are as follows:

**1**) Lean back.

**2**) Face directly uphill while bringing the brake hand across the chest.

**TRANSITION:** Are there any questions concerning the seat-shoulder rappel? If not, let us discuss the seat-hip rappel.

**7.** (10 Min) **SEAT-HIP RAPPEL.** The seat-hip rappel is the most commonly used rappel.

**a.** **Conduct.** A seat-hip rappel is conducted in the following manner:

**1** ) Construct the rappel seat; roll down sleeves and put gloves on.

**2** ) The steel locking carabiner is placed on the rappel-seat so that the gate opens up and away.

**3** ) Step up to the rope with your left shoulder facing the anchor.

**4** ) The rappel rope is snapped into the carabiner as follows:

**a)** Snap the rope into the locking carabiner.

**b** ) Taking slack from the standing (anchor) end of the rope, make one wrap with the rope around the body of the carabiner and through the gate again.

**c)** Ensure that the locking nut of the carabiner is fastened to lock the carabiner closed.

#### **SEAT-HIP RAPPEL**

**NOTE:** If you are using only one rope to rappel with due to the tactical situation or equipment availability, the procedures are the same, EXCEPT the individual will make two wraps around the body of the carabiner instead of one.

**5** ) The rappeller will grasp the running end of the rope with the brake (right) hand, palm down and turned slightly inboard, near the hip.

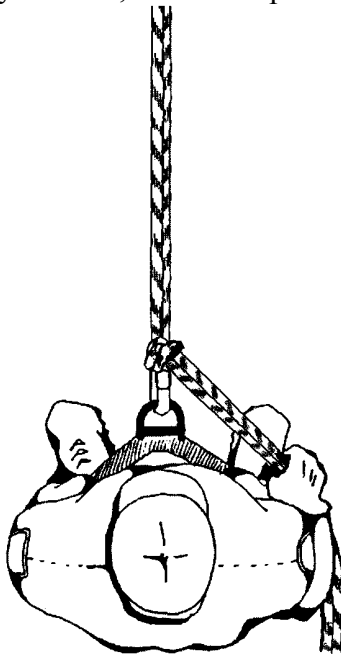

**RAPPELLER WITH BRAKE HAND ON ROPE**

b. Braking. The steps in braking for a seat-hip rappel are as follows:

1. Grasp the rope tightly with the brake hand.

2. Take the brake hand and place it in the small of the back. This will create enough friction to stop all momentum.

**NOTE:** At no time will you bound or jump while you are descending. You "walk down" the cliff face using the proper braking procedure to control your rate of descent.

**TRANSITION:** Now that we have discussed the hasty rappel, seat- shoulder rappel and the seat-hip rappel, are there any questions? Let's now talk about the safety factors of the first man down.

8. (5 Min) **SAFETY OF THE FIRST MAN DOWN**. To ensure the safety of the first man down, the rappeller will:

a. Before deploying the ropes, tie the two ends of the ropes together with an overhand knot.

b. Tie a friction knot on the standing end of the rappel rope with a Prusik cord.

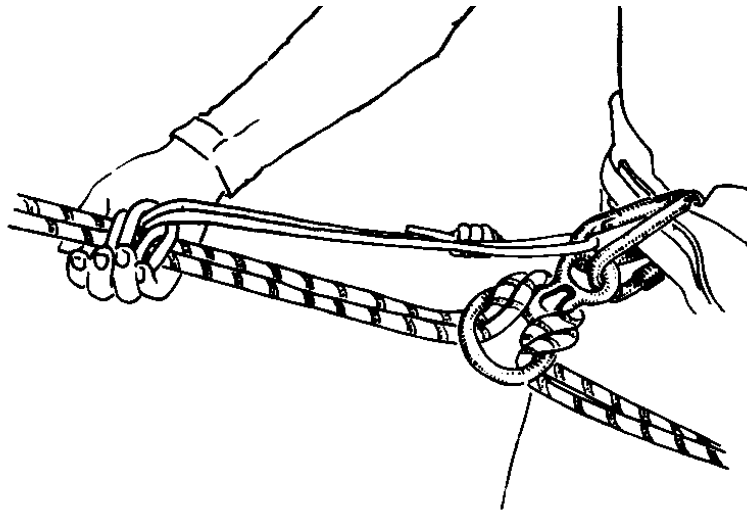

**SAFETY PRUSIK**

c. Attach the rappel ropes to the harness's hard point with a locking carabiner.

d. Attach the Prusik cord to the harness's hard point with a locking carabiner. This cord is also referred to as a safety Prusik.



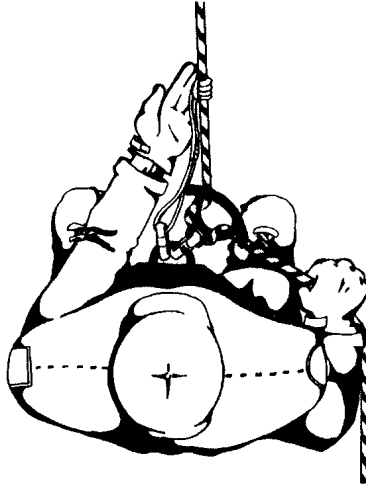

**RAPPELLER WITH SAFETY PRUSIK**

**NOTE:** If the Safety Prusik is too short, it can be extended with a web runner.

**TRANSITION:** We've just discussed the safety of the first man down, are there any questions? Now let's talk about the duties of the first man down.

**9.** (10 Min) **DUTIES OF THE FIRST MAN DOWN.** The first man down the rope has specific duties. They are as follows:

- a.** Selects a smooth route down for the ropes.
- b.** Clears the route of loose rocks and debris.
- c.** The first man down will untie the overhand knot and straighten the ropes out once he reaches the bottom.
- d.** The first man down belays the next man down the rope. There are two methods of belaying the next man down. The method used will be decided upon the restriction of the unloading platform.

(1) Confined unloading platform:

- a)** The belay man will stand facing the cliff face, arms up with palms facing upward and overlapping. The rope will pass through the opening of the overlapping hand's thumb and index fingers.

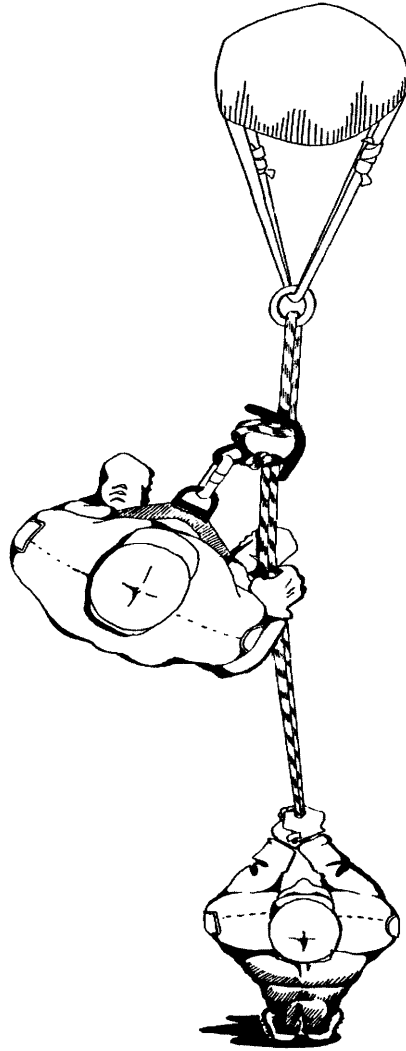

**RAPPELLER AND BELAY MAN**

- b )** To stop a fallen rappeller, the belay man will grab the rope with closed fists and pull straight down bringing the forearms parallel to the deck.

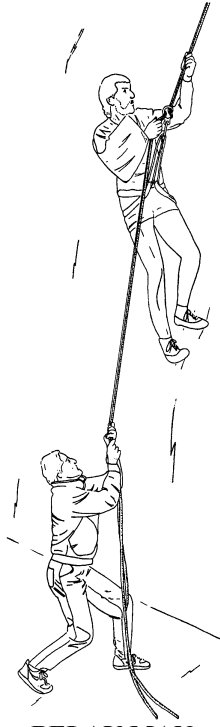

**BELAY MAN**

(2) Open unloading platform:

- a) The belay man should stand facing the cliff with the ropes under both arms and behind his back.
- b) To stop a fallen rappeller, the belay man will move away from the cliff face while holding the ropes firmly as in a standing hip belay.
- e. Take charge of personnel as they arrive at the bottom to include appointing a belay man.

TRANSITION: Now that we have discussed the duties of the first man down, are there any questions? Next we will discuss the individual rappelling commands.

**10.** (5 Min) **RAPPELLING COMMANDS.** In order to conduct rappelling operations safely, it is essential that everyone understands the sequence of events. The following voice commands or rope tugs will be utilized:

**TRANSITION:** Are there any questions about the rappelling commands or rope tugs? If not, let us discuss the possibility of tying off.

(10 Min) **TYING-OFF.** Occasionally, it may be necessary to stop during a rappel before reaching the bottom of a cliff. The following sequence is used:

**a.** The commands used in tying-off are as listed below:

**b.** The procedure used when tying-off is as follows:

- 1** ) The rappeller gives the command, "Lane #, tying-off."
- 2** ) The belayer gives the rappeller slack and gives the command "Lane # Tying-off". He continues to hold the rope in the belay position, remaining alert and watching the rappeller.
- 3** ) The rappeller quickly brings his brake hand to the twelve o'clock position, so that the running end and standing end are parallel.
- 4** ) The rappeller grasps all ropes with his guide hand as close to the carabiner as possible.
- 5** ) The rappeller steps over the rope so that the running end is going between his legs.
- 6** ) The rappeller releases the rope with his brake hand then reaches under the running end, over the standing end. He then takes up a bight from the running end about two feet long and pulls it over the standing end and under the running end, forming a half hitch.
- 7** ) He pulls the half hitch tightly against the guide hand.
- 8** ) He works the half hitch down snugly against the carabiner while maintaining contact with the guide hand as long as possible.

**NOTE:** A loose half hitch could bind into the carabiner causing difficulties in clearing the knot out. Make sure that the first half hitch is dressed down tightly before moving it against the carabiner.

9 ) Place another half hitch above the one already tied.

10 ) To untie, reverse the steps. Remove the safety half hitch, then shrink the first half hitch down to a small loop by grabbing the running end of both ropes and pulling them straight out to the left. Place your right hand in the middle of the two bights until they are snug on all four fingers. Then remove one finger and make the bights snug on three fingers. Repeat this process until it's down to one finger and both the bights are equal.

11 ) Now, grasp the running end with both hands and smartly jerk the running end of the ropes upward to pop the small loop out from the first half hitch. From this position, keep the guide hand around both of the ropes next to the carabiner; step back over the rope so that the running end is to your right side. Grab just the running end with your brake hand and quickly set the brake behind the small of your back then, readjust your guide hand onto the standing end. You now should be in the seat-hip rappel position.

**NOTE:** The wraps may bind up some after untying, where no further movement down is possible. To alleviate this, keep the brake on and force your body weight down to pop the wraps in the carabiner back to their intended position and then continue on with the rappel.

12 ) The rappeller gives the command "Lane #, on rappel."

13 ) The belayer takes up the slack and gives the command "Lane #, on belay."

14 ) The rappeller resumes to rappel down.

**TRANSITION:** Are there any questions over tying off? We will now discuss how to perform different types of rescues during rappelling operations.

11. (5 Min) **RESCUE TECHNIQUES.** When conducting rappelling operations, the possibility of a rappeller getting caught on the rope due to either his clothing or equipment can occur. There are two types of rescues that can be performed to free the rappeller from this situation.

a. The Self-Rescue Technique.

1 ) After realizing that you are caught up on the rope, check with your belay man to ensure that he has a solid brake set.

2 ) Using a safety Prusik, tie a friction knot onto the rappel rope approximately an arms length above the area that is fouled. Anchor the other end of your safety Prusik to your rappel seats hard point. This is the same technique used as discussed earlier with the first man down the rope.

3 ) Work the friction knot up until there is no tension on the rappel device. This will give you the necessary slack to free the malfunction.

4 ) Once you have corrected the problem, continue to rappel down using the first man down method.

b. The Buddy Rescue Technique. This method is used when the rappeller is unable to correct the problem by himself.

1 ) A rescuer will rappel down on another rope to the disabled rappeller and tie-off.

2 ) The rescuer will then establish a safety Prusik onto the victim as taught in the self-rescue technique.

3 ) After clearing the malfunction, continue with rappelling operations.

c. Rappelling Casualty Rescue. There are three different methods in which to get an injured rappeller to the bottom.

1 ) The first method is to allow the belay man to lower the casualty by slowly releasing the tension on the rappel rope.

2 ) The second method is used for critical injuries or when the belay man cannot properly control the casualty's descent.

a) The rescuer will rappel down using another rope. Once the rescuer gets to the casualty, the rescuer will have his belay man brake him off, enabling the rescuer to use both hands.

b ) If necessary, the rescuer will perform the basic first aid needed. Once the casualty is ready to be lowered, the rescuer will call down to both of the belay men to simultaneously lower both men. The rescuer will hold onto the casualty the entire way down so that he doesn't bounce off the rock face.

3 ) The third method is called a tandem rappel. Its used to rescue a casualty who has sustained an injury serious enough that he cannot operate the rappel device himself and requires the assistance of a second rappeller. This type of rescue can be conducted from the top of the cliff face or while on rappel, depending on where the injury occurred.

a) If the injury occurs while on top of the cliff face, the following steps should be taken:

1. Take either a long sling rope or Prusik cord and tie a figure-eight knot offset so that one length of the cord is longer than the other.

2. Tie a figure-eight knot at each end.

3. Take a rappel device and attach it to the offset figure-eight loop with a carabiner and attach it to the rappel rope.
4. Next, attach the casualty's hard point to the short end of the sling rope/Prusik cord and the rescuer to the other end.
5. The rescuer will then utilize a safety Prusik in the same method as the first man down technique, except that the friction knot will be tied below the rappelling device and controlled with the brake hand.
6. The rescuer will then maneuver himself under the casualty to provide assistance and support.
7. At this point you are ready to rappel both rescuer and casualty at the same time.

**NOTE:** Your rappel device should be far enough in front of you so that the casualty will not be able to reach it.

**b**) If the injury occurs during the rappel, the following steps are taken:

1. The rescuer will preset the same system on a separate rappel rope and rappel down to the casualty.
2. The rescuer will then take the short end of the sling rope and attach it to the casualty's hard point.
3. With a knife, the rescuer will cut the casualty's rappel rope away.
4. Rappel down to the bottom of the cliff face.

**NOTE:** THIS IS THE ONLY TIME THAT A KNIFE WILL BE USED DURING A RAPPEL. EXTREME CAUTION SHOULD BE USED. IT IS NOT TO BE DONE IN TRAINING, BUT ONLY DURING AN ACTUAL RESCUE AND AS A LAST RESORT.

**TRANSITION:** Are there any question over rescue techniques? Let's now discuss how to make our rappel installation retrievable.

**12.** (10 Min) **RETRIEVABLE RAPPELS**. Once a unit has rappelled down a vertical obstacle, it may be necessary to retrieve the rope(s). Depending on the height of the obstacle either one or two ropes will used to construct the rappel lane.

**a.** One-Rope Retrievable Rappel:

**1**) Find the middle of the rope and place it directly behind a suitable anchor point.

2 ) Join the pigtails of the rope with an overhand/figure 8 knot and deploy the rope down the obstacle.

3 ) On one side of the rope in front of the anchor point, tie an over-the-object clove hitch onto a locking carabiner.

4 ) On the other side of the rope, tie a figure 8 loop and attach it to the same carabiner.

5 ) The first man down will utilize a safety Prusik and untie the overhand knot after he reaches the bottom.

6 ) All others conduct proper rappel procedures.

7 ) The last man down will disconnect the carabiner from the rope, and ensuring that the middle of the rope is directly behind the anchor point, rappel down the rope. If point NCO is an assault climber, use the stitch plate/ATC-type belay device to straighten the ropes.

8 ) The rope is then retrieved by pulling on either end of the rope.

b. Two-Rope Retrievable Rappel. This type of system is identical to the one rope retrievable rappel except for a few considerations.

1 ) The reason for using two ropes vice one rope is that the height of the rappel is greater.

2 ) When two ropes are used they should be joined together using a square knot. This knot will be placed out of the system when securing the carabiner to the ropes. This will prevent total failure of the system if the knot should fail.

3 ) All else remains the same as the one rope retrievable rappel except:

a) The last man down will disconnect the carabiner from the rope and will move the joining knot as close to the vertical obstacle's edge as possible. This will prevent the knot from possibly getting caught up while retrieving.

b) The last man down will then place a carabiner on the rope below the knot. This will enable him to know which line to pull for retrieval. If the last man down is an assault climber, use the stitch plate/ATC-type belay device to straighten the ropes.

TRANSITION: Now that we have covered retrievable rappels, are there any questions? As Marines we are required to carry a variety of weapons and equipment into combat. Let us discuss considerations for our equipment so that it doesn't enable our rappelling efforts.

**13.** (3 Min) EQUIPMENT. Equipment should be worn in accordance with unit SOP. The unit has the responsibility to determine which methods it feels are most beneficial to the mission.



Weapons should be worn across shoulder; muzzle down and away from the brake hand with a tight sling securely attached to the weapon. Weapons should also be dummy corded to the individuals.

TRANSITION: Are there any questions over equipment at this time? If you have none for me, then I have some for you.

**PRACTICE** (CONC)

- a. Students will execute all rappel considerations outlined.

**PROVIDE HELP** (CONC)

- a. The instructors will assist the students when necessary.

**OPPORTUNITY FOR QUESTIONS** (3 Min)

**1. QUESTIONS FROM THE CLASS**

**2. QUESTIONS TO THE CLASS**

**Q.** What are the three criteria involved in site selection for a rappel site?

- A.** (1) Good anchors.  
(2) The route down the cliff face should be as free of obstacles as possible.  
(3) There must be suitable loading and unloading platforms.

**Q.** What are the three types of rappels?

- A.** (1) Hasty Rappel  
(2) Seat-Shoulder Rappel  
(3) Seat-Hip Rappel

**Q.** When would the hasty rappel be the desired type of rappel to use?

- A.** When carrying loads down a moderate slope.

**SUMMARY** (2 Min)

- a. During this period of instruction we have covered site selection, how to establish a rappel site and how it should be run, which included duties of the rappel point NCOIC and duties of the first man down a rope. We've also covered how to establish a retrievable rappel and the three types of rappels, as well as how to tie-off.
- b. Those of you with IRF's please fill them out at this time and turn them in to the instructor.

We will now take a short break.

UNITED STATES MARINE CORPS  
Mountain Warfare Training Center  
Bridgeport, California 93517-5001

SML  
SMO  
ACC  
02/11/02

**LESSON PLAN**

**BALANCE CLIMBING**

---

**INTRODUCTION**

(5 Min)

- 1. GAIN ATTENTION.** In almost every mountain operation, you will be required to negotiate rocky slopes and faces. "While not all will require technical skills, some of them will and you will be unable to accomplish your mission unless you have mastered the basic skills of balance climbing.
- 2. OVERVIEW.** The Purpose of this period of instruction is to introduce the student to the techniques used in balance climbing. This will be accomplished by discussing safety requirements, individual preparations, commands, types of holds, and considerations for body position and movement. This lesson relates to top roping and cliff assaults. (SMO)

**INSTRUCTOR NOTE:** Have students read learning objectives.

**3. INTRODUCE LEARNING OBJECTIVES**

- a. TERMINAL LEARNING OBJECTIVE.** In a summer mountainous environment, execute balance climbing, in accordance with the references.
- b. ENABLING LEARNING OBJECTIVES.** (MLC) and (ACC)
  - 1 )** Without the aid of references, describe in writing the safety requirements for balance climbing, in accordance with the references.
  - 2 )** Without the aid of references, list in writing the individual preparations for a balance climb, in accordance with the references.
  - 3 )** In a summer mountainous environment, execute the duties of a spotter for a balance climb, in accordance with the references.
  - 4 )** In a summer mountainous environment, execute the commands used between the climber and the spotter during a balance climb, in accordance with the references.

5 ) In a summer mountainous environment, execute each type of hold used in balance climbing, in accordance with the references.

6 ) Without the aid of references and given the acronym "CASHWORTH", describe in writing the considerations for proper body position while climbing, in accordance with the references.

c. ENABLING LEARNING OBJECTIVES. (SMO)

1 ) With the aid of references, state orally the safety requirements for balance climbing, in accordance with the references.

2 ) With the aid of references, state orally the individual preparations for a balance climb, in accordance with the references.

3 ) In a summer mountainous environment, execute the duties of a spotter for a balance climb, in accordance with the references.

4 ) In a summer mountainous environment, execute the commands used between the climber and the spotter during a balance climb, in accordance with the references.

5 ) In a summer mountainous environment, execute each type of hold used in balance climbing, in accordance with the references.

6 ) With the aid of references and given the acronym "CASHWORTH", describe orally the considerations for proper body position while climbing, in accordance with the references.

4. **METHOD/MEDIA.** The material in this lesson will be presented by lecture and demonstration. You will practice what you have learned in upcoming field training exercises. Those of you with IRF's please fill them out at the conclusion of this period of instruction.

5. **EVALUATION.**

a. MLC - You will be tested later in the course by written and performance evaluations on this period of instruction.

b. ACC - You will be tested later in the course by written and performance evaluations on this period of instruction.

c. SMO - you will be tested by an oral and performance examination.

**TRANSITION:** Are there any questions over the purpose, learning objectives, how the class will be taught, or how you will be evaluated? Civilians call what you are about to learn "Bouldering". The Marine Corps refers to it as balance climbing. Regardless of the term used, the techniques you will be learning are the basis upon which all your other climbing training will rest. By

practicing the techniques you are about to learn, you will acquire the skills necessary to operate successfully in any area where you might encounter precipitous terrain. The first thing we need to know in balance climbing are the safety precautions.

## **BODY**

(60 Min)

**1.** (5 Min) **SAFETY PRECAUTIONS.** There are two safety precautions that always apply to balance climbing. They are as follows:

- a.** Never climb more than 10 feet above the ground. By this it is meant that the climber's feet are never more than 10 feet above the ground.
- b.** A spotter is required for all balance climbs.

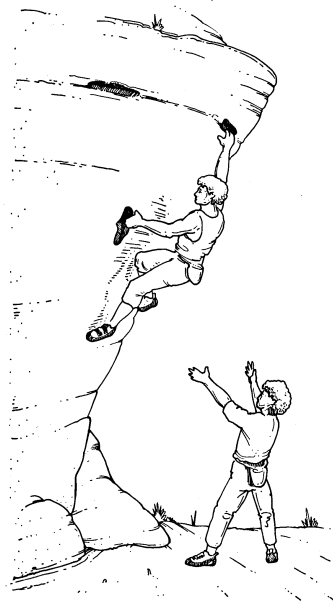

**SPOTTER WATCHING THE CLIMBER**

**TRANSITION:** Now that we have discussed the safety precautions, are there any questions? The next thing we will discuss are what an individual has to do to prepare himself for a balance climb.

**2.** (5 Min) **INDIVIDUAL PREPARATIONS.** Prior to beginning a balance climb there are seven things that the climber must do to prepare himself. They are as follows:

- a.** Helmet with a serviceable chinstrap must be worn.
- b.** Sleeves rolled down to give hand and arm freedom of movement. Blouse tucked in to your trousers. In case of fall, it may catch on a rock and cause you to flip over sideways.
- c.** All watches, rings, and jewelry must be removed before climbing.

- d. Gloves will not be worn, as they can slip, and also give a false feel for the rock.
- e. Unblouse trousers, if they restrict movement.
- f. Soles of boots clean and dry.
- g. Select route where vegetation is minimal. Never use vegetation for hand or foot holds.

TRANSITION: Are there any questions over the individual preparations? As I mentioned, you never balance climb without a spotter. Who is this "spotter and what are his duties?"

**3.** (5 Min) **DUTIES OF THE SPOTTER**. The spotter is the balance climber's partner who, rather than climbing himself, acts as the safety man for the climber during the climb. The five duties of the spotter are as follows:

- a. Positions himself directly behind the climber before the climb starts.
- b. Maintains his position facing the cliff, directly below the climber and approximately 3-4 feet away from the base of the cliff, for the duration of the climb. He will move diagonally as necessary to remain below the climber.
- c. The spotter will stand with his feet shoulder width apart and arms ready to stop the climber if he falls.
- d. If the climber falls, the spotter will not "catch" him; he will prevent the climber from falling further down the hill. He will do this by pushing the climber towards the base of the cliff, thereby preventing him from tumbling backwards.
- e. At no time will the spotter allow anyone to come between himself and the face of the cliff while a balance climb is taking place. He will require anyone who wants to pass by his position to go behind him.

TRANSITION: Are there any questions over the duties of the spotter? Now we're almost ready to go out and start climbing. However, before that, let's learn the commands used between the climber and spotter.

**4.** (5 Min) **SPOTTING AND CLIMBING COMMANDS**. The following are the commands used by both the spotter and climber.

a. If the command "ROCK" is given, all personnel in the vicinity will take the following action:

1 ) If close to the cliff face, move against the cliff face with your face against the cliff face and your hands between you and the cliff face.

2 ) If not close to the cliff face, look up to locate the rock and avoid it.

5. (5 Min) **ACTIONS IF FALLING**. If, while making a balance climb, the climber feels himself slipping and beginning to fall, he will take the following action:

a. Sound the command "falling".

b. Push himself away from the rock face.

c. Maintain proper body position as follows:

1 ) Head up.

2 ) Hands out toward the rock.

3 ) Body relaxed.

4 ) Feet kept below the body, slightly apart.

5 ) Ensure you face the cliff face as you fall.

TRANSITION: Now that we have discussed the safety precautions and considerations, are there any questions? Let's move on to the actual climbing.

6. (5 Min) **TYPES OF HOLDS**. There are five basic holds that are used in balance climbing. They are as follows:

a. Push Holds.

1 ) Most effective when hands are kept low.

2 ) Often used in combination with a pull hold.

#### **TYPES OF PUSH HOLDS**

**b.** Pull Holds.

1 ) The easiest hold to use and, consequently, often overused.

2 ) Can be effective on small projections.

**TYPES OF PULL HOLDS**

**c.** Foot Holds

1 ) Feet should be positioned with the inside of the foot to the rock.

2 ) Use full sole contact as much as possible.

3 ) Avoid crossing your feet. If you must cross your feet use a change step. A change step is a method of substituting one foot for the other foot on the same foothold.

4 ) Making maximum use of footholds, climbing with your feet, is an effective means of conserving your body strength, since your leg muscles are stronger than your arm muscles.

**USE OF FOOT HOLDS**

**d.** Friction Holds. A friction hold is anytime you are relying on the friction of your foot or hand against the face of the rock for traction, rather than pushing/pulling against a projection on the face of the rock.

1 ) It is a type of hold that feels very insecure to an inexperienced climber.

2 ) The effectiveness of this type of hold is dependent upon many things i.e., type, condition and angle of the rock face, type of boot soles, confidence, etc.

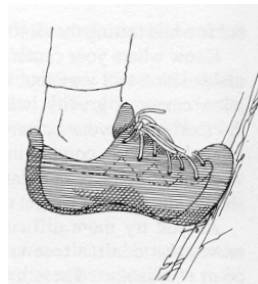

**FRICION USED IN SMEARING**

**e.** Jam Holds. This type of hold involves jamming/wedging any part of your body or your entire body into a crack/opening in the rock.

1 ) An important consideration is that you do not jam such that you cannot



free that portion of your body after you complete the move. This sounds like a ridiculous statement; however, you must remember that after you complete your move, you may be withdrawing the portion of your body that you used from a different angle than you inserted it.

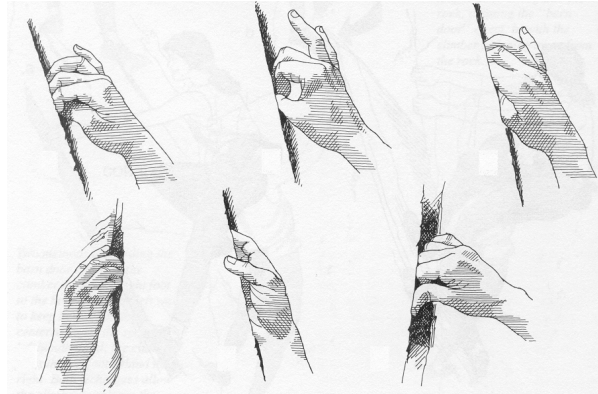

**FINGER JAMS**

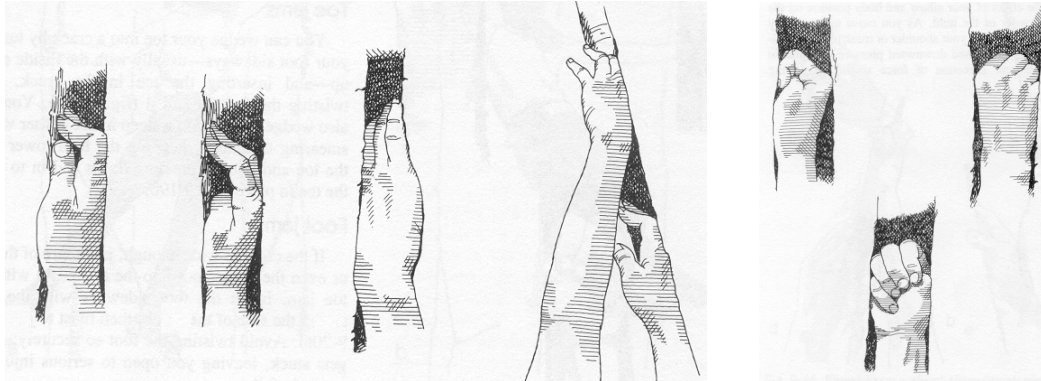

**HAND JAMS**

**FIST JAMS**

**7.** (5 Min) **COMBINATION HOLDS.** The five types of holds just mentioned above are not just used individually. They are most often used in combinations with each other. Some examples are:

**a.** Chimney Climbing. This is when you insert your entire body into a crack in the rock and by using both sides of the opening, and possibly all five types of basic holds, move up' the crack.

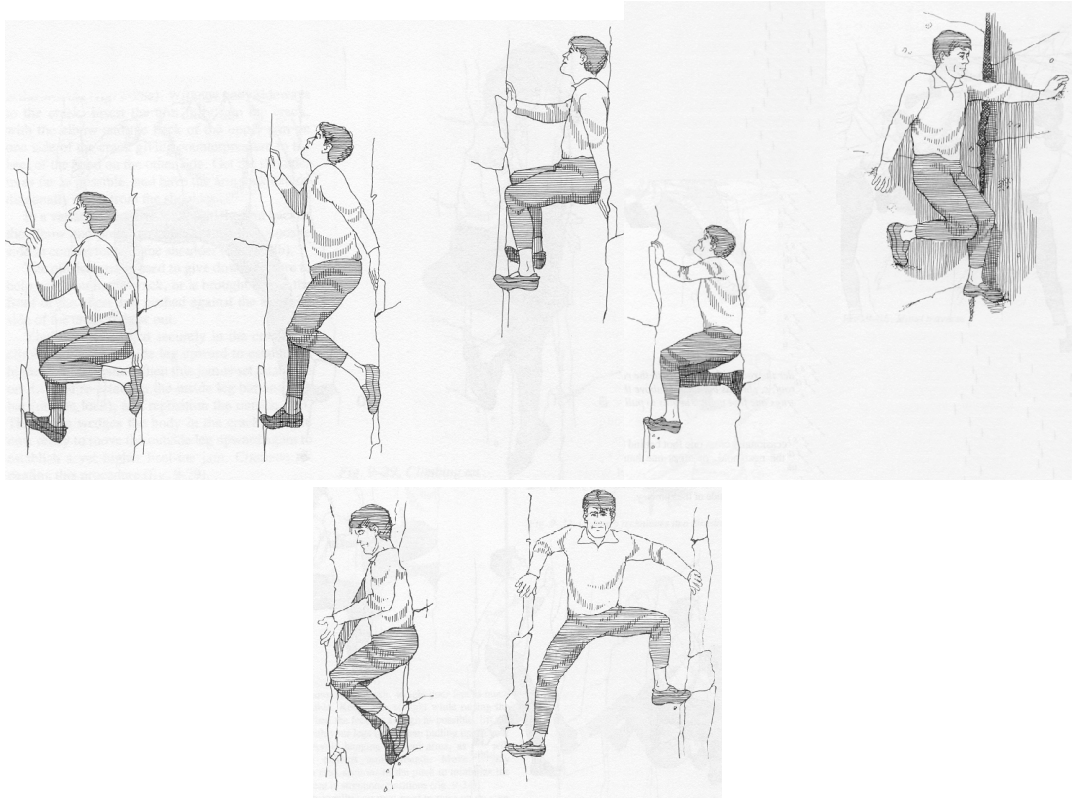

### **CHIMNEY CLIMBING TECHNIQUES**

- b.** Lie-back. This is a combination of both pull holds with your hands and friction holds with your feet.



### **LIE BACK TECHNIQUE**

- c.** Push-Pull. As the name implies, this is when you use a push hold and a pull hold together.

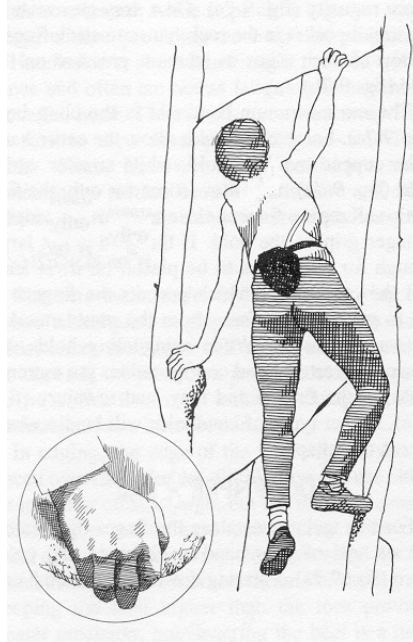

**PUSH-PULL**

- d.** Mantling. This is a technique where you continue to climb without moving your hands off a projection by pulling yourself up until your hands are at chest level and then invert your hands and push on the same projection.

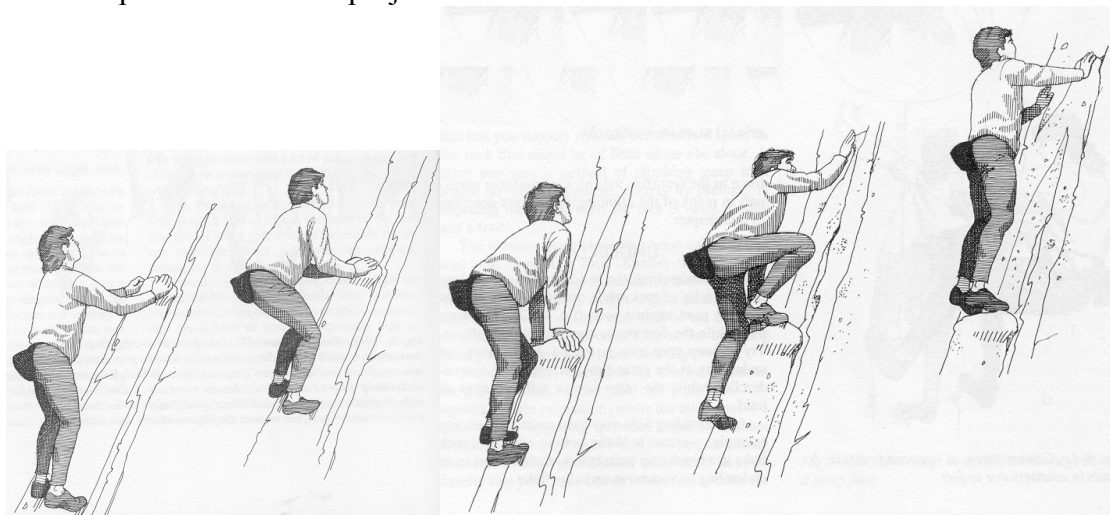

**MANTELING**



**MANTELING WITH FACE HOLD**

- e. Cross-Pressure in Cracks. This is a technique of putting both hands in the same crack and pulling your hands apart to hold/raise yourself.

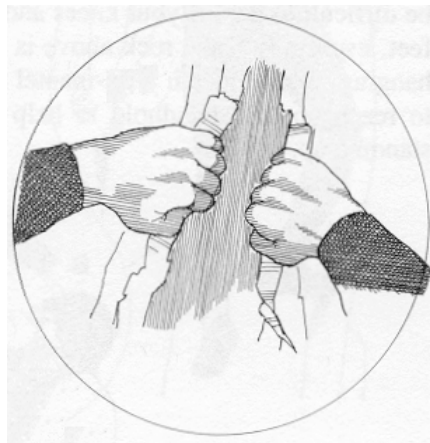

**CROSS-PRESSURE METHOD**

- f. Inverted. Pull or push.

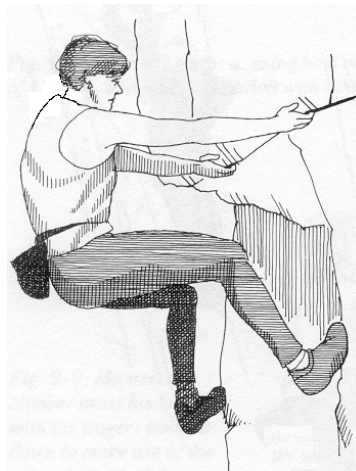

**INVERTED TECHNIQUE USING COUNTERFORCE  
PRESSURE BETWEEN FEET AND HANDS**

**g.** Pinch. As the name implies this is a grip used on tiny little nubbins.



**PINCH**

**h.** Stemming. The spreading of arms or legs to maintain a proper body position. (i.e. usually used in a book or chimney.)

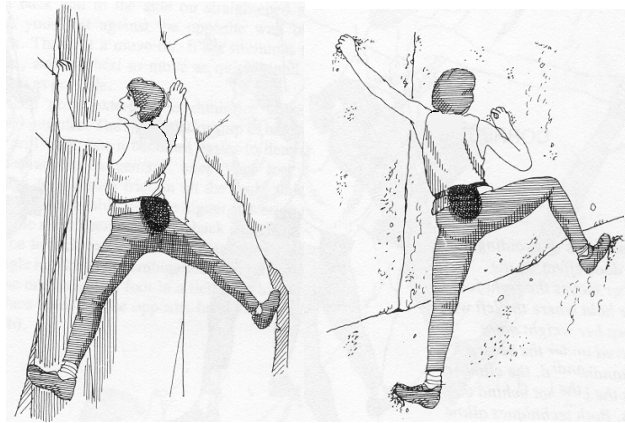

**STEMMING**

TRANSITION: Are there any questions over the types of holds? There are some general guidelines that aid the climber that we should be aware of

**8.** (5 Min) **GENERAL USE OF HOLDS**. How you use an individual hold is dependent on your experience level, or sometimes, your imagination. Here are some general guidelines.

- a.** Most handholds can be used as foot holds as you move up the rock.
- b.** Use all holds possible in order to conserve energy.
- c.** Even small projections may be used as holds.
- d.** Do not make use of your knees or elbows due to the reason that it is skin on bone and a slip could occur if pressure is exerted on them. Knees and elbows can be used with the extension of a limb jam.

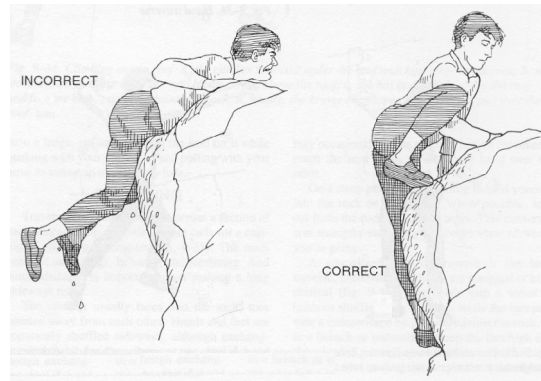

**PROPER AND IMPROPER**

**9.** (5 Min) **MOVEMENT ON SLAB.** Movement on slab is based on friction holds.

- a.** Use any and all irregularities in the slope to gain additional friction.
- b.** Traversing requires both hands and feet.

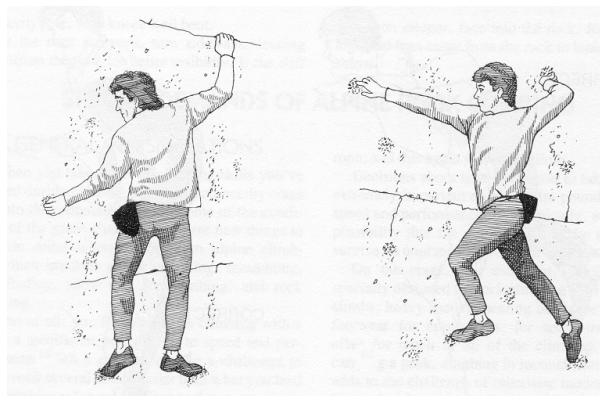

**TRAVERSING**

- c.** Descending steep slab may require turning inboard to face the slab and backing down.
- d.** The biggest mistake in slab climbing is leaning into the rock. Maintain maximum friction by keeping weight centered.

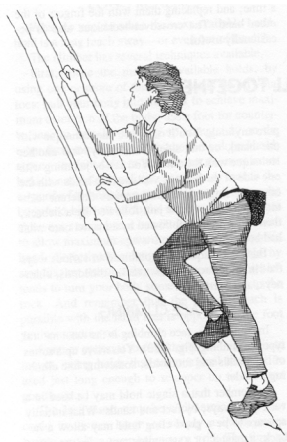

**SLAB CLIMBING**

TRANSITION: Are there any questions on the general use of holds or movement on slab? To help us maintain proper body position, we will use the acronym "CASHWORTH".

**10.** (5 Min) **BODY POSITION**

- a.** The climber should climb with his body in balance by keeping his weight centered over and between his feet. Don't hug the rock. Don't over extend and become "spread-eagled". While climbing, keep in mind the acronym "CASHWORTH" for proper body position and movement.

**C** - Conserve energy.

**A** - Always test holds.

**S** - Stand upright, on flexed joints.

**H** - Hands kept low; handholds should be waist to shoulder high.

**W** - Watch your feet.

**O** - On three points of contact.

**R** - Rhythmic movement.

**T** - Think ahead.

**H** - Heels kept low, lower than the toes.

TRANSITION: Now that we have covered cashworth, are there any questions? Following these principles will aid you in a less tiring and stressful climb. Above all remain calm. If there are no questions for me, then I have some for you.

**PRACTICE** (CONC)

- a.** Students will execute balance climbing.

**PROVIDE HELP** (CONC)

- a.** The instructors will assist the students when necessary.

**OPPORTUNITY FOR QUESTIONS** (3 Min)

**1. QUESTIONS FROM THE CLASS**

**2. QUESTIONS TO THE CLASS**

**Q.** What are the two safety requirements for balance climbing?

- A.** (1) Never climb higher than 10 feet above the ground.  
(2) A spotter is required for all balance climbs.

Q. Name five types of holds?

- A.** (1) Push.  
(2) Pull.  
(3) Foot.  
(4) Friction.  
(5) Jam.

**Q.** What is the meaning of the acronym "CASHWORTH"?

- A.** C - Conserve energy.  
A - Always test holds.  
S - Stand upright on flexed joints.  
H - Hands kept low.  
W - Watch your feet.  
O - On three points of contact.  
R - Rhythmic movement.  
T - Think ahead.  
H - Heels kept low.

## **SUMMARY**

(2 Min)

- a.** During this period of instruction, we have talked about what balance climbing is, the safety precautions that must be used in balance climbing, the proper body position and the acronym "CASHWORTH". We have also discussed different types of holds and the duties of both the climber and the spotter.
- b.** Those of you with IRF's please fill them out at this time and turn them into the instructor. We will now take a short break.



**UNITED STATES MARINE CORPS**  
Mountain Warfare Training Center  
Bridgeport California, 93517-5001

SML  
ACC  
SMO  
02/11/02

**LESSON PLAN**

**TOP ROPING**

**INTRODUCTION**

(5 Min)

- 1. GAIN ATTENTION.** On June 6, 1944, the allied forces performed one of the greatest feats in the history of warfare, an opposed landing on hostile enemy territory. Part of the plan for this landing called for elements of the United States Army to scale the cliffs above the landing beaches. This was accomplished by the use of ladders, which were transported to the cliff head on the landing craft, no one had to lug them around. But in a real mountainous environment you probably will not have this luxury. Fortunately we are accomplishing the same mission with a coil of climbing rope, and I submit to you, would you rather carry a sixty foot ladder around or a 150 foot coil of rope.
  
- 2. OVERVIEW.** The purpose of this period of instruction is to introduce the student to top roping. This will be accomplished by discussing the preparations for climbing, belaying, and commands. This lesson relates to cliff assaults.

**INSTRUCTOR NOTE:** Have students read learning objectives.

**3. INTRODUCE LEARNING OBJECTIVES.**

**a. TERMINAL LEARNING OBJECTIVE.** In a summer mountainous environment, and given a rock face and a belay man, conduct top roping with cartridge belt and rifle, in accordance with the references.

**b. ENABLING LEARNING OBJECTIVE.** (SML) and (ACC).

**1. )** In a summer mountainous environment, establish a belay stance from the top of a cliff for use in a top rope climb, in accordance with the references.

**2. )** In a summer mountainous environment, belay a climber using a Munter Hitch, in accordance with the references.

**3. )** In a summer mountainous environment, demonstrate the use of climbing commands while conducting a top rope, in accordance with the references.

**c. ENABLING LEARNING OBJECTIVES. (SMO).**

**1**) In a summer mountainous environment, belay a climber using a Munter Hitch, in accordance with the references.

**2**) In a summer mountainous environment, state orally the climbing commands used while conducting a top rope, in accordance with the references.

**4. METHOD/MEDIA.** The material in this lesson will be presented by lecture and demonstration method. You will practice what you have learned in upcoming field exercises. Those of you with IRF's please fill them out at the end of this period of instruction.

**5. EVALUATION**

**a.** MLC - You will be tested later in the course by written and performance evaluations.

**b.** ACC - You will be tested by a performance exam.

**c.** SMO - You will be tested by a performance examination.

**TRANSITION:** Are there any questions over the purpose, learning objectives, how the class will be taught, or how you will be evaluated? First, let's discuss the preparations for establishing a belay stance from the top.

**BODY**

(55 Min)

**1. (15 Min) ESTABLISHING A BELAY STANCE FROM THE TOP**

**a.** The belayer will establish a sitting belay stance on the cliff head by:

**1**) Constructing a suitable anchor with the standing end of the rope.

**2**) With the direction of pull away from the anchor, tie a directional figure 8 loop near enough to the cliff's edge so that the climber can be observed, if possible.

**3**) Tying a swammi Wrap around oneself, clip a locking carabiner through all the rear wraps and clip a large locking carabiner through all the front wraps.

**4**) Secure the rear locking carabiner into the directional figure of 8 loop.

**5**) Secure the running end of the rope to the large locking carabiner utilizing a suitable friction belay (i.e., munter hitch, stitch plate, etc.).

**NOTE:** Gloves will not be worn while belaying a climber during a top rope.

**TRANSITION:** Are there any questions over establishing a belay stance from the top? If not, let's discuss securing the climber to the rope.

**2. (5 Min) SECURING THE CLIMBER TO THE ROPE**

**a.** The climber will tie into the end of the top rope by:

**1** ) Constructing a Swammi wrap around oneself.

**2** ) Tying a retrace figure 8 loop through all of the Swammi's wraps or;

**3** ) A figure of 8 loop clipped into a locking carabiner secured through all the Swammi's wraps.

**b.** Alternative methods.

**1** ) A bowline on a coil as discussed in ROPE MANAGEMENT or;

**2** ) Tie into the hard point of the harness as discussed in SIT HARNESS.

**TRANSITION:** Are there any questions over the securing of the climber to the rope? Let's talk about establishing a belay stance from the bottom.

**3. (15 Min) ESTABLISHING A BELAY STANCE FROM THE BOTTOM.**

**a.** Belaying from the bottom is commonly referred to as a "Yo-Yo" or "Sling Shot" belay. This system can be constructed for either a direct or indirect belay.

**1** ) Construct a suitable top anchor utilizing either a pulley or one steel locking or two non-locking carabiners as the attachment point for the anchor.

**2** ) The rope will travel up from the bottom and pass through the attachment point then return to the bottom.

**3** ) The climber will be secured to one end of the rope and the belayer from the other end.

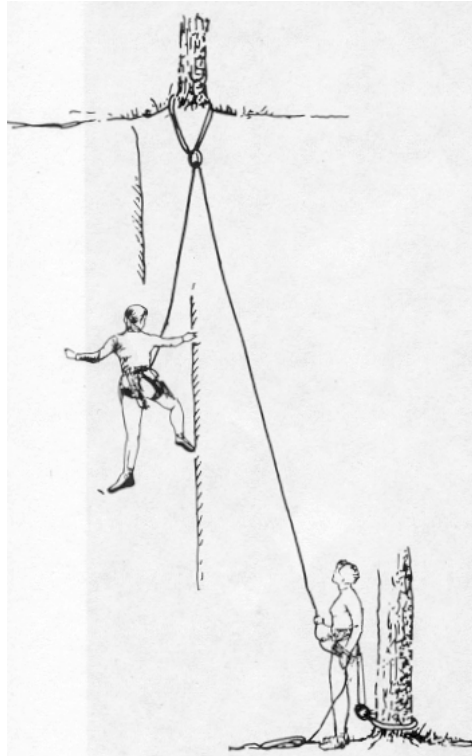

**BELAY STANCE FROM THE BOTTOM**

TRANSITION: Are there any questions concerning the establishment of a bottom belay stance for a top rope? Let's discuss the climber's responsibilities.

**4. (5 Min) CLIMBER'S RESPONSIBILITIES**

- a.** The climber ensures that the belayer is anchored and on belay, by use of commands or prearranged signals prior to beginning the climb.
- b.** The climber will not out climb the belayer; this will cause slack in the rope between the belayer and the climber.
- c.** Avoid placing excess pressure/weight on belay man.
- d.** Weapons will be worn across shoulder, muzzle down and to the left, with a tight sling securely attached to the weapon.

TRANSITION: Are there any questions over the climber's responsibilities? Let's discuss the commands for the climber and his belay man.

**5. (5 Min) CLIMBING COMMANDS AND SIGNALS.** In order to conduct top rope operations safely, it is essential that everyone understands the sequence of events. The following voice commands or rope tugs will be utilized:

TRANSITION: Without the proper usage of commands, injuries can occur. Are there any questions over the commands? If you have none for me, then I have some for you.

**PRACTICE** (CONC)

- a. Students will conduct and establish a belay for top roping.

**PROVIDE HELP** (CONC)

- a. The instructors will assist the students when necessary.

**OPPORTUNITY FOR QUESTIONS**

1. QUESTIONS FROM THE CLASS (3 Min)

2. QUESTIONS TO THE CLASS

**Q.** What are the climber's responsibilities?

**A.** (1) Ensure the belayer is anchored and on belay prior to beginning his climb.

2 ) Don't out climb his belayer.

3 ) Avoid placing excess pressure/weight on the belayer.

4 ) Ensure equipment is properly secured.

**Q.** What is the climbing voice command when all excess rope has been taken up between the climber and belay man?

**A.** "That's me"

## **SUMMARY**

(2 Min)

- a.** During this period of instruction we have discussed how to establish a top and bottom belay stance, the responsibilities of the climber, climbing commands, and preparations prior to top roping.
- b.** Those of you with IRF's please fill them out at this time and turn them in to the instructor. We will now take a short break.

**UNITED STATES MARINE CORPS**  
Mountain Warfare Training Center  
Bridgeport, California 93517-5001

SML  
ACC  
02/11/02

**LESSON PLAN**

**SIT HARNESS**

**INTRODUCTION**

(5 Min)

- 1. GAIN ATTENTION.** The number of climbing sit harnesses available in the world today is quite staggering. Here at the MWTC, in co-operation with Yates Inc., we have designed a climbing sit harness that can be used for a multitude of mountaineering tasks, including two party climbing on rock or ice, rescues, rappelling, big wall climbing, and the other interests. It is one of the first harnesses made in the USA that has passed the UIAA test and is rated to 5950 lb. Further, it is a one size fits all harness.
- 2. OVERVIEW.** The Purpose of this period of instruction is to familiarize the students with the MWTC sit harness, its component parts, how to care for it, how to put it on and adjust it for a comfortable fit, and how to tie into it.

**INSTRUCTOR NOTE:** Have students read learning objectives.

**3. INTRODUCE LEARNING OBJECTIVES**

**a. TERMINAL LEARNING OBJECTIVE**

- 1** Without the aid of references, properly wear and maintain the MWTC sit harness, in accordance with the references.

**b. ENABLING LEARNING OBJECTIVES**

- 1** Without the aid of references and given a diagram, name in writing the parts of a sit harness, in accordance with the references.
- 2** Without the aid of references, wear a sit harness, in accordance with the references.

- 4. METHOD/MEDIA.** The material in this lesson will be presented by lecture and demonstration. You will practice what you have learned during upcoming field training exercises. Those of you with IRF's please fill them out at the conclusion of this period of instruction.

## 5. EVALUATION

- a. SML - You will be tested by written and performance evaluation.
- b. ACC - You will be tested by a written exam and performance evaluation throughout the course.

TRANSITION: Are there any questions over the purpose, learning objectives, how the class will be taught, or how you will be evaluated? During this period of instruction we will cover the nomenclature of the SIT harness, the wearing of the harness, tying into a rope, and care and maintenance. Let's first go over nomenclature of the sit harness.

### BODY

(35 Min)

#### 1. (5 Min) NOMENCLATURE

- a. Waist belt.
- b. Leg loops (adjustable).
- c. Buttocks straps (adjustable).
- d. Fastex buckle - 2.
- e. Doughnut.
- f. Equipment loops.
- g. D-ring (older models).
- h. Waist belt tie-in point.
- i. Crotch strap.

b

**NOTE:** The harness is made out of various size mountaineering tape and should be maintained in the same manner as a climbing rope is, refer to ROPE MANAGEMENT.

TRANSITION: Are there any questions over the nomenclature? Let's discuss the wearing of the harness.

#### 2. (5 Min) WEARING OF THE SIT HARNESS

- a. First, disconnect the fastex buckle at the rear of the harness.
- b. Hold the harness in front of you, put your feet through the leg loops ensuring that the



buckles on the leg loops are outboard, on your thighs.

- c.** Fasten the waist belt into the buckle, ensuring that it is a tight but comfortable fit. **You must ensure that the waist belt is threaded back through the buckle, this action locks the waist belt to the buckle. Failure to do this will cause the waist belt to slip through the buckle when it is under load.**
  
- d.** Adjust the leg loops so that they are high on your thigh, once you have them adjusted, get your buddy to clip the fastex buckle male to the most comfortable female fastex. Then adjust the buttock straps so as the leg loops are held up.
  
- e.** If all the above are done correctly, the harness should now be a comfortable but snug fit, after you have fitted it for the first time there is no need to go through the same procedure each time you put it on. Simply hold the harness in front of you, step into it and attach the waist belt to the buckle in the approved manner.

TRANSITION: Are there any questions over the wearing of the sit harness? Let's talk about tying in the rope to the sit harness.

**3.** (5 Min) **TYING IN THE ROPE (END OF ROPE)**

- a.** Pass the end of the climbing rope up through the crotch strap, then through the doughnut and through the waist belt tie-in point.
  
- b.** Tie the rope using a retraceable figure eight, adjusting the knot to get it as close as possible to the body.

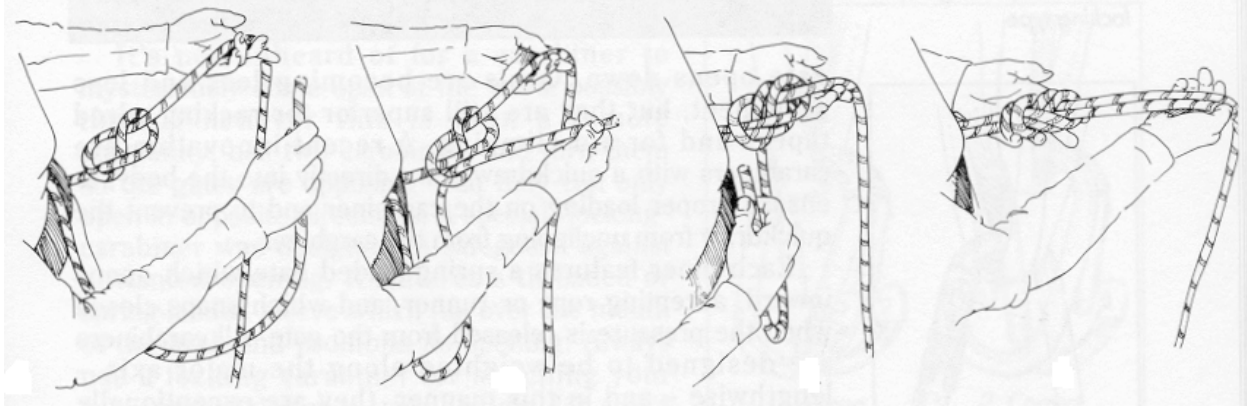

**RETRACE FIGURE 8 IN SIT HARNESS**

**4. (5 Min) TYING IN THE ROPE (MIDDLE OF THE ROPE)**

- a. Take up a bight of rope and tie a figure eight loop, then take a steel locking carabiner and attach the carabiner to the harness by securing the crotch strap, doughnut, and the waist belt tie-in loop. Now attach the figure eight loop to the carabiner.

**5. (5 Min) CARE AND MAINTENANCE**

- a. Avoid contact with chemicals, as this will damage the nylon.
- b. Regularly inspect for signs of abrasions and normal wear. Pay particular attention to wear points such as the tie-in loops, buckles, and sewn joints.
- c. Keep away from heat such as open flames, cigarettes, etc.
- d. If soiled by grit and sea water, wash in lukewarm water with pure soap and allow to dry in a warm room away from direct heat.
- e. Two to three years of life can be expected during normal climbing use.
- f. It is recommended that a harness that has experienced a serious fall should be discarded.
- g. Under no circumstances will you ever tie into the equipment rack of any sit harness as a belay, anchor point, etc.

**NOTE:** The time to discard a harness is on a climber's own discretion.

**TRANSITION:** Now that we have discussed tying in and care, are there any questions? If you have none for me, then I have some for you.

**PRACTICE**

(CONC)

- a. The students will properly use the sit harness.

**PROVIDE HELP**

(CONC)

- a. The instructors will assist students when necessary.

**OPPORTUNITY FOR QUESTIONS**

(3 Min)

**1. QUESTIONS FROM THE CLASS**

**2. QUESTIONS TO THE CLASS**

Q. What is the nomenclature of the sit harness?

- A. (1) Waist belt.  
(2) Leg loops (adjustable).  
(3) Buttocks straps (adjustable).  
(4) Fastex buckle - 2.  
(5) Doughnut.  
(6) Equipment loops.  
(7) D-ring.  
(8) Waist belt tie-in point.  
(9) Crotch strap.

**SUMMARY**

(2 Min)

- a. What we have just covered is the nomenclature, wearing, care and employment of the MWTC sit harness.
- b. Those of you with IRF's please fill them out and turn them in to the instructor. We will now take a short break.

UNITED STATES MARINE CORPS  
Mountain Warfare Training Center  
Bridgeport, California 93517-5001

SML  
ACC  
02/11/02

**LESSON PLAN**

**PLACING PROTECTION**

**INTRODUCTION**

(5 Min)

- 1. GAIN ATTENTION.** As a lead climber, the success of the climb relies not only on your ability to climb but also on your ability to protect yourself. No matter how well your belay man is at belaying or how good your equipment is, if the protection is improperly placed, the consequences of a fall could be death or serious injury.
- 2. OVERVIEW.** The purpose of this period of instruction is to introduce the student to the basics of pro placement to include placement of chocks, SLCD's, hexes, properly clipping the rope into this protection and how to rack protection. This lesson relates to party climbing.

**INSTRUCTOR NOTE:** Have students read learning objectives.

**3. INTRODUCE LEARNING OBJECTIVES.**

**a. TERMINAL LEARNING OBJECTIVE.**

- 1. )** In a summer mountainous environment, and given the proper equipment, place rock climbing protection, in accordance with the references.

- 4. METHOD/MEDIA.** The material in this lesson will be presented by lecture and demonstration. You will practice what you learned during upcoming field training exercises. Those of you with IRF's please fill them out at the end of this lesson.

**5. EVALUATION.**

- a.** MLC - You will be tested by a performance evaluation during the passout climb.
- b.** ACC - You will be tested by a performance evaluation during the passout climb.

**TRANSITION:** Are there any questions over how the class will be taught or how you will be evaluated? Our first topic will be placing protection and anchors.

**BODY**

(50 Min)

1. (5 Min) **GENERAL**. Placing protection is the skill of establishing points of protection along the route by using natural features or by lodging artificial devices in the rock. The leader clips the rope through each piece of protection, while the belayer at the bottom of the pitch waits in position to hold the leader if he should fall. This technique makes lead climbing safely possible. Since carabiners are used in all protection placements, the novice should learn some general principles as for their use:
  - a. The gates of the carabiners clipped into the pro should be down and out, or the gates should be down and facing to whichever side minimizes the risk of the gate being forced open by a rock edge or nubbin during a fall.
  - b. Rope should be run from the climber through the carabiner without twists and kinks.
  - c. When using a runner, be sure the runner is not twisted before clipping into the carabiner; otherwise, the carabiner may end up facing the wrong way.
2. (10 Min) **NATURAL FEATURES AS PROTECTION**. Natural features offer some of the very best protection but should always be tested for stability as discussed in *NATURAL AND ARTIFICIAL ANCHORS*.
  - a. Trees
    1. Trees provide the most common and obvious natural protection. To attach the runner to a tree, wrap the runner around the tree and clip a carabiner into both looped ends.
    2. The runner should usually be as low on the tree trunk as possible, although it may sometimes be desirable to put it higher up or even on a branch to avoid creating a sharp bend in the climbing rope or to provide a higher point of protection.
  - b. Scrubs and Bushes
    1. Locate the central root and construct the anchor as near to the base as possible to avoid leverage.
  - c. Rocks and Boulders
    1. Extreme caution should be used when utilizing rocks and boulders because of the danger it poses if it should come loose. Always ensure that the intended stone is well embedded or is too heavy to move.
    2. Place the runner at the base of the stone to prevent possible leverage.

**d. Spikes and Flakes**

- 1) Spikes and flakes often provide good placement. A runner is attached by placing it over the spike / flake as near the base as possible. Sometimes, to prevent the action of the climbing rope from pulling the runner off, it can be attached to the spike / flake with a girth hitch.
- 2) When possible, avoid placing the runner where it may be pulled against a sharp edge of the rock in a fall. When this is unavoidable, padding sharp edges with another runner or other soft material may be helpful.

**e. Threads and Chockstones**

- 1) Runners can be threaded through the holes or placed around the chockstone and clip a carabiner into both looped ends.

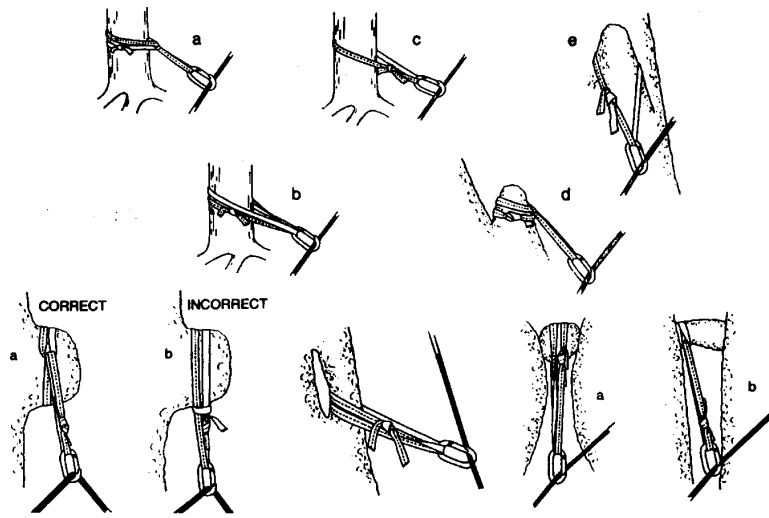

**NATURAL FEATURES AS PROTECTION**

3. (15 Min) **ARTIFICIAL PROTECTION**. In the absence of natural protection, climbers will use artificial protection devices known as chocks, spring-loaded cams and bolts.
  - a. Chocks. The principle in placing chocks is deceptively simple; find a crack with a constriction at some point and place a chock of the appropriate size above the constriction and pull down on the loop to set the chock. Chocks can either be passive, meaning it sits in a constricting crack until it takes a load then wedges itself into the crack. Or it can be camming meaning that the chock is placed in a crack in such a way that when it takes a load it tries to rotate. The rotation causes the chock to cam and lock into place. However simple in theory, placing chocks require a good eye and some experience. There are basically two different types of chocks used at MWTC, wedges and hexcentrics.

- 1) Wedges. This is a passive chock that is also known as a stopper, wire or nut. A wedge chock has a wired loop attached to it and is tapered down from top to bottom

so that it can fit into the constriction of a crack. It is constructed to have a wide side, the strongest side, and a narrow side. The goal is to get the greatest possible contact between the chock and the rock.

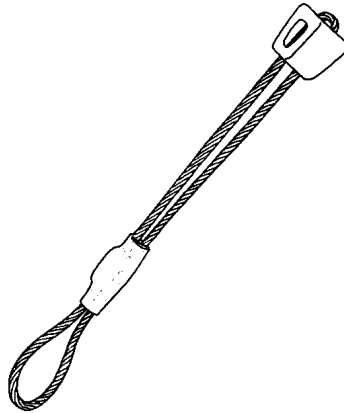

**STOPPER**

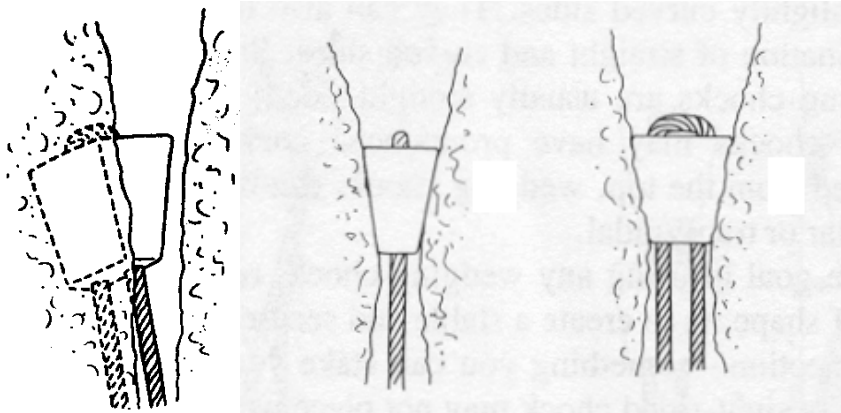

**CORRECT STOPPER PLACEMENT**

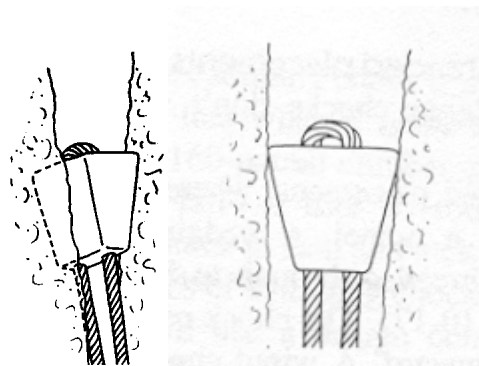

**INCORRECT STOPPER PLACEMENT**

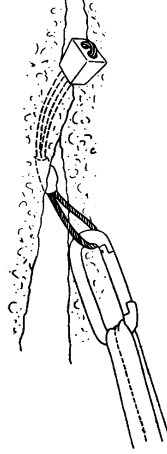

**STOPPER THREADED THROUGH TUNNEL IN A CRACK**

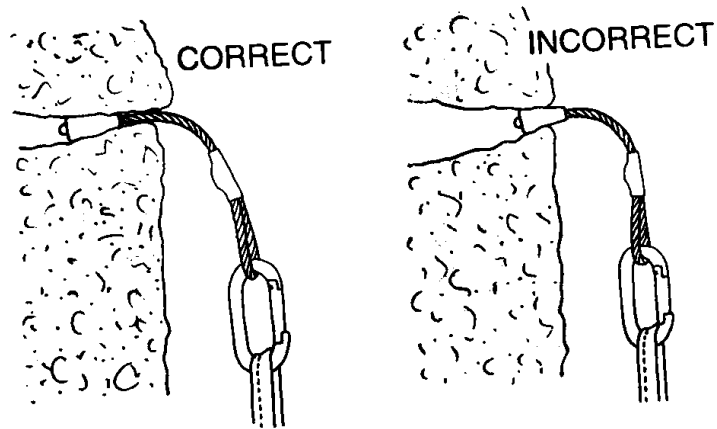

**STOPPER PLACEMENT ON A LIP**

2 ) Hexcentrics. These chocks can be used in either the passive or camming mode and are also known as hexes. Hexcentric chocks have a wired or Type I cordage loop attached to it and have six different sized sides that are tapered, allowing it to be placed into a constricting crack.

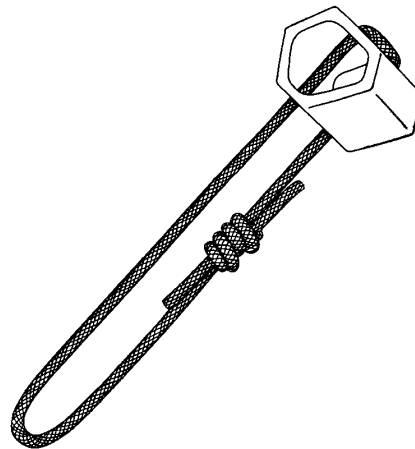

**HEXCENTRIC**



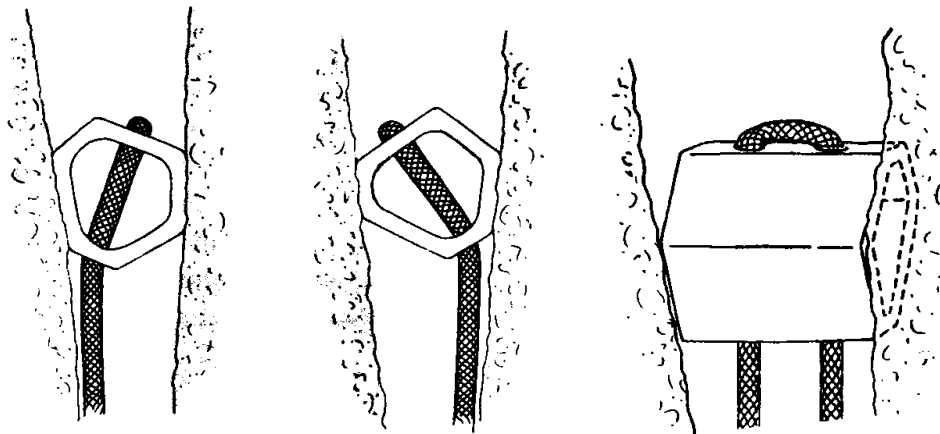

**HEXCENTRIC PLACEMENT**

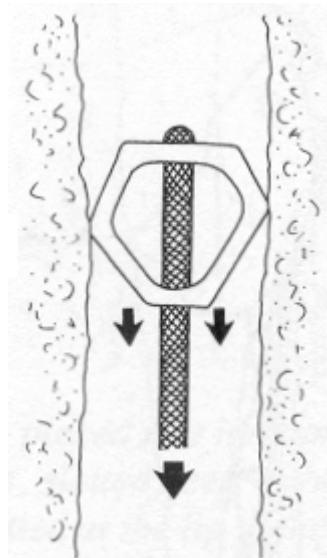

**INCORRECT HEXCENTRIC PLACEMENT**

**3 )** The following factors should be considered when placing chocks:

- a)** When possible, avoid cracks that have crumbly or deteriorating rock on one side. Many cracks that look good could have a small, loose flake on one side; often well disguised with grass and dirt. Some very tempting cracks are in fact formed by a detached flake against a large mass of rock.
- b )** When attempting to place a chock, always look for a likely constriction in the crack first, then select a chock that will fit, rather than selecting a chock and looking for somewhere to put it.
- c)** When a place is found, choose a chock that will have as much surface area as possible in contact with the rock. A chock with just one side resting on a small crystal is likely to be unsound and unsafe. A chock that sticks partially out of a crack is usually poor protection. If the crack is too shallow to get the chock all the

way in, use a smaller chock or find a deeper portion of the crack.

- d) When placing a #1 or #2 stopper, always back that piece up with a secondary piece of protection as soon as possible.

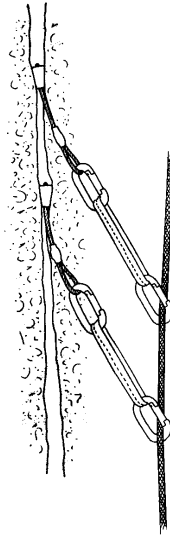

**BACKING UP A #1 OR #2 STOPPER**

- e) Outward flaring cracks are a problem. A few types of chocks are specifically designed to fit in flaring cracks as long as the angle of the flare is not too great.

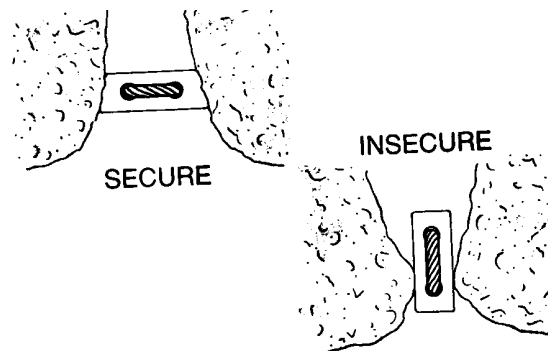

**INCORRECT PLACEMENT IN FLARING CRACK**

- f) Stacking Chokes. Parallel-sided cracks can produce a problem. Chocks of various sizes can be stacked in many ingenious ways, but only one method will be described here. If two wedge shaped chocks are placed in contact, one upside-down, their surfaces will be approximately parallel. If the pair barely fits into a parallel-sided crack, they are set firmly and the rope is clipped into the one placed right side up (loop to the direction of pull). The upper chock should be clipped to the lower one in some way to keep it from being lost if the placement should pop out.

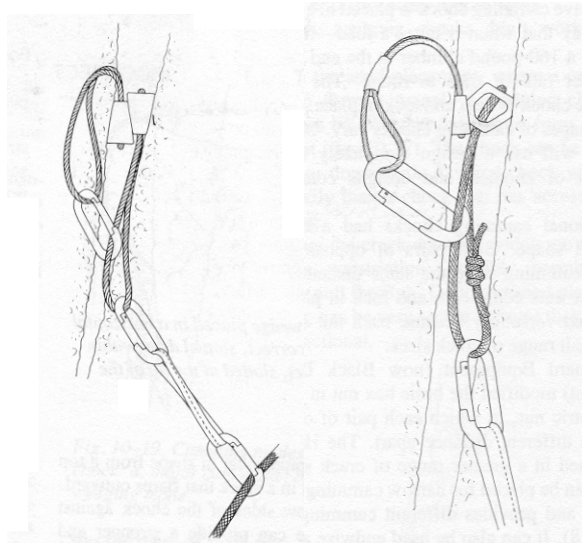

**STACKED CHOCKS**

**g)** Horizontal cracks can take simple placements if the interior of the crack is wider than the edges at some point. If not, a placement of stacked chocks may hold. In either case if the chock is on a rope loop which runs over a sharp lower edge, as often happens, it cannot be depended on to hold a hard fall, for the loop may be cut. If it is on a wire it is usually safe.

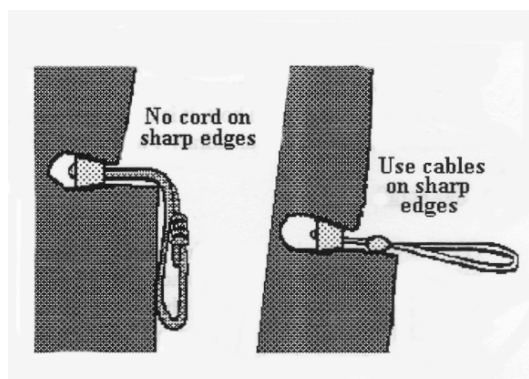

**CHOCKS ON EDGES**

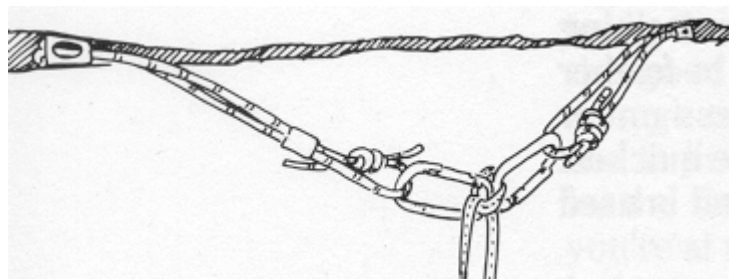

**STOPPER PLACEMENT IN A HORIZONTAL CRACK**

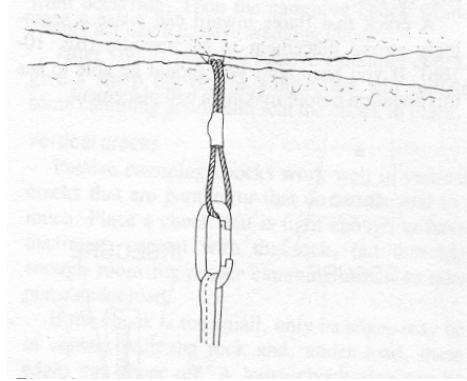

**STOPPER PLACEMENT BEHIND HORIZONTAL CRACK**

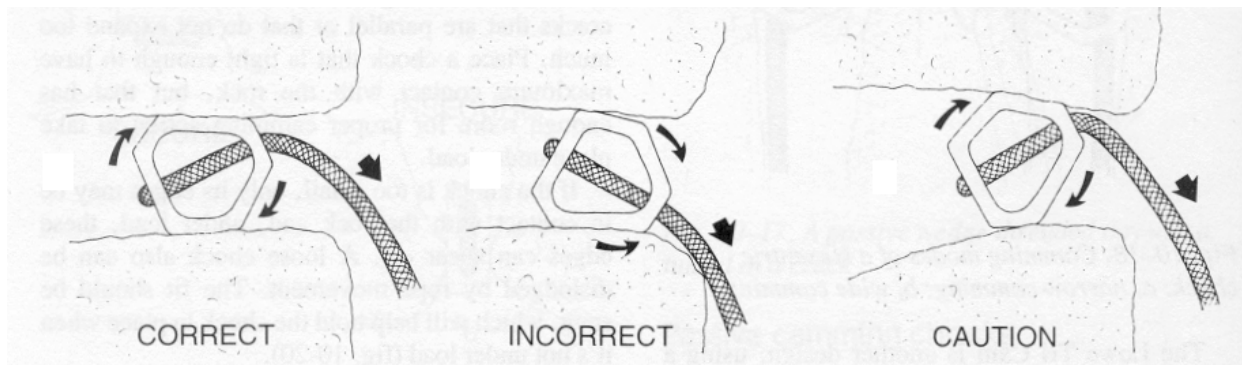

**HEXCENTRIC PLACEMENT IN A HORIZONTAL CRACK**

- h.)** When placing a chock with a rope loop, the side of the loop with the knot should face out when there is a choice, in order to ensure that at least one-half of the loop fits into the crack. When the loop will not fit into the crack at all, a wired chock is usually a better choice. Once a chock is placed, the climber can either clip the climbing rope into it directly or extend the chock loop with a runner. The loop of a wired chock is always extended with a quick draw to prevent "walking" the pro out of the rock. Ensure that enough quick draws are carried to use on placements.
- b.** Spring-Loaded Camming Devices (SLCD). This is a mechanical device known as quadcams or camalots. The four cams in a spring-loaded camming device, also known as lobes, are connected to a trigger mechanism. Pull the trigger and the cams retract, narrowing the profile of the device so it can fit into a particular crack. Release the trigger and the cams again rotate outward expanding the profile until the cams grip the sides of the crack. SLCD's provide reliable placements in cracks where ordinary chocks are difficult or impossible to place; such as parallel-sided cracks, flaring cracks, and cracks under roofs. They can be placed quickly and make it possible to do some extremely difficult pitches that are otherwise virtually impossible to protect.

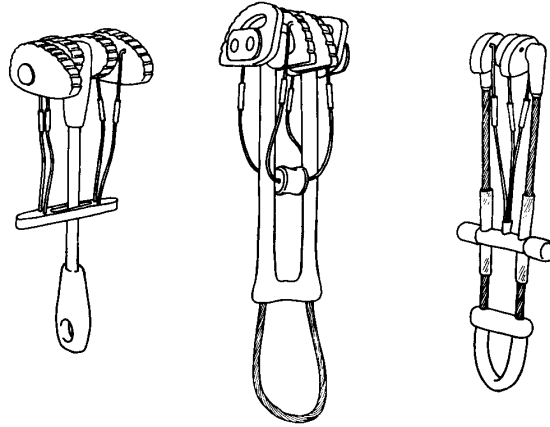

**SPRING LOADED CAMMING DEVICES**

**1**) The following factors should be considered when placing SLCD:

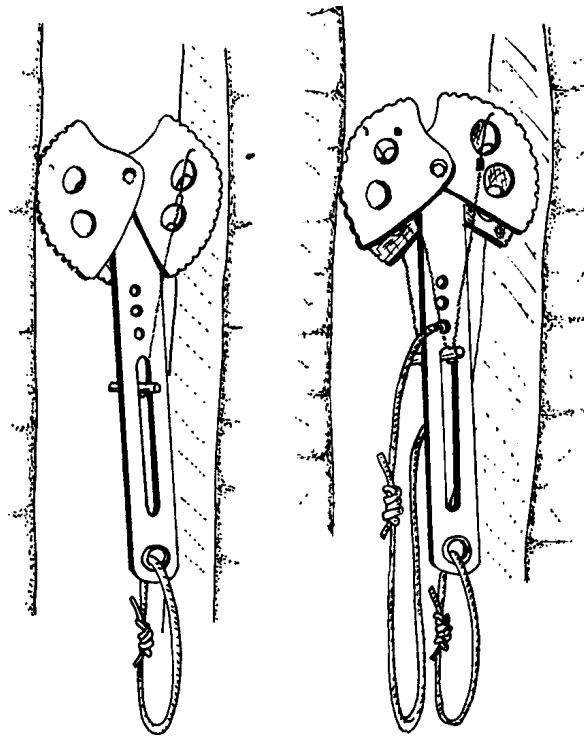

**CAM PLACEMENT**

- a)** Care should be taken to ensure all individual cams of the SLCD have a good purchase on the rock. If one or more cams have no purchase, this is considered improper placement, and an SLCD can easily be pulled out of the rock when a fall is taken.
- b)** If the trigger must be pulled all the way back to place the SLCD into a crack, the cams will be over-retracted (over-cammed)

preventing the SLCD from performing properly. It may also be impossible to remove. Use a smaller one or another type of pro.

- c) Avoid under camming, where the cams are over expanded causing the cams to rock on its tips; also known as “tipped” placement.

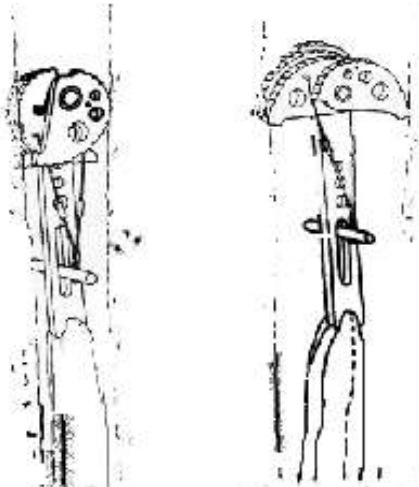

**INCORRECT CAM PLACEMENT**

- d) Do not put the SLCD any deeper into the crack than it has to be for a good placement. If placed too deeply, it may be impossible to reach the trigger to remove it.
- e) When placed behind flakes or in deep cracks, SLCD's have been known to "walk up" into the crack out of reach as a result of rope action. A SLCD should be extended with a runner in such placements to reduce the possibility of the pro walking.
- f) Always align a SLCD's stem and cams in the direction of pull.

### **c. Fixed Bolts**

- 1) Fixed bolts are often found in civilian rock climbing areas and are not uncommon on alpine rock climbs. Bolts are most commonly used for belay anchors, but also provide protection on otherwise unprotected stretches of rock.
- 2) Bolts generally provide the best and certainly the most convenient protection. Unfortunately, they are not always sound and should be checked. Bolts can be checked by examining the rock around them for evidence of crumbling or cratering, and they should be tested by clipping into them with a separate carabiner and jerking on it before clipping in the rope. Never hammer on a bolt to test or improve it, since this will permanently weaken it.

- 3 ) When clipping into a bolt, it is best to do so with a carabiner-runner-carabiner combination, known as a “quickdraw”, which will reduce rope drag.

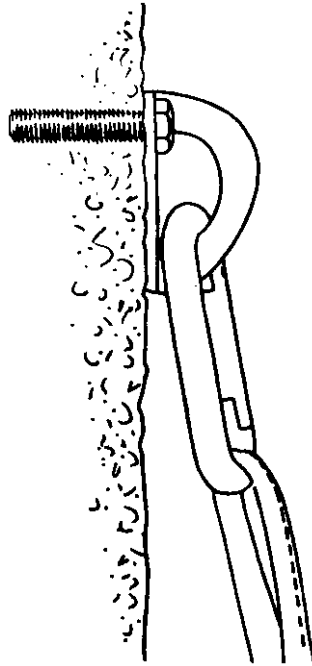

**FIXED BOLT**

**TRANSITION:** Now that we have discussed placing protection, are there any questions? Next, we will discuss clipping in.

4. (5 Min) **ATTACHING THE ROPE TO THE PROTECTION**. After placing a piece of protection, the climber must secure his climbing rope to it. The carabiner is the basic tool used to connect the climbing rope to the protection. As easy as it sounds, there are factors to consider when clipping the rope into the carabiner:
- a. Ensure that the gate of the carabiner is facing away from the rock, especially near books and edges. If necessary, extend the protection with a runner.
  - b. Always place the carabiner so that the gate is facing down and away. Depending on the climber’s route of travel will decide which direction the gate is facing:
    - ① When traversing left of the protection, the gate will face toward the right.
    - ② When traversing right of the protection, the gate will face toward the left.
    - ③ When climbing straight up, the gate direction will not matter but ensure that it is facing away from sharp edges.

- c. To clip the carabiner, grab the rope from your retrace figure of eight and pull up a bight. If a bigger bight is necessary, hold the rope between your teeth and pull up a bigger bight.
- d. Always clip the carabiner from the rear to the front. This will prevent the rope from backtracking over the gate causing it to unclip during a fall. This is also known as “The Death Clip”.
- e. The carabiner should allow the rope to run smoothly without twists or kinks. Always inspect the run of the rope through the carabiners to ensure against “Z” clips.
- f. When this is done correctly, the rope going to your retrace figure of eight should be coming out of the front of the carabiner. The rope going to the belayer will be between the carabiner and the rock.

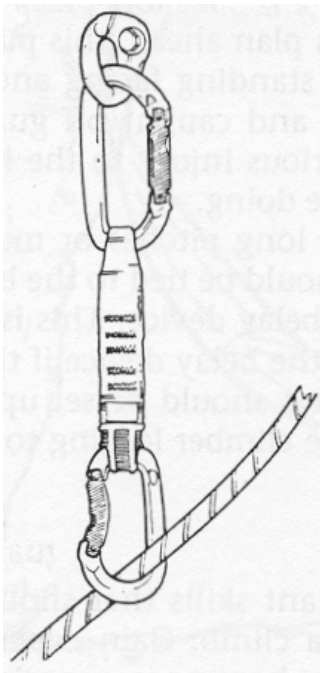

**CORRECT ROPE AND CARABINER PLACEMENT**

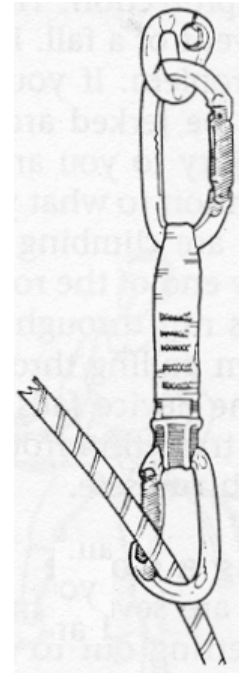

**INCORRECT CARABINER PLACEMENT**

**TRANSITION:** Are there any questions over clipping in? Next we will discuss the racking of equipment.

- 5. (5 Min) **RACKING EQUIPMENT.** A climber's selection of gear for protection is called his rack. A rack consists of a varying numbers of chocks, SLCD's, carabiners and quick draws. Pro should be carried in a logical sequence of size and type so that the lead climber can quickly find the correct type for the crack he wishes to fit. Pro can be carried on an equipment sling across the body, attached to the equipment loops on the harness, or a combination of both. The amount of pro carried is dependent upon the type of climb to be attempted. The following are methods for racking:



**INSTRUCTOR NOTE:** Have students take their full racks for the first couple days of climbing until they learn what they need to take.

- a.** Rack several pieces of pro of the same size on one carabiner, arranging these on the rack in order of size. This has the advantage of having extra pro on hand if you don't get the placement right the first time.

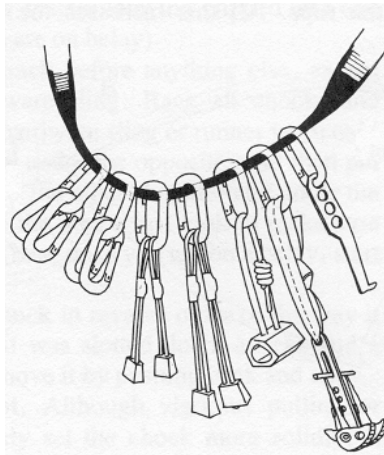

**PROTECTION GROUPED TOGETHER**

- b.** Long slings are worn by doubling the loop over and clipping both ends with a carabiner.
- c.** Quick draws are preset carabiner and runner combinations that allow quick and easy extension of a piece of protection. It is helpful to have the gates of the carabiners opposite of each other so that the bottom carabiner is down and away from the rock. This makes clipping in much easier.
- d.** Other items such as a stitch plate, rappel gloves, chock pick, etc., need to be placed at the back of the harness.



### **RACKED EQUIPMENT ON CLIMBER**

**TRANSITION:** Now that we have covered racking equipment, are there any questions? Are there any questions over the amount of gear? If you have none for me, then I have some for you.

### **PRACTICE**

(CONC)

- a. Students will properly place climbing protection.

### **PROVIDE HELP**

(CONC)

- a. The instructors will assist the students when necessary.

### **OPPORTUNITY FOR QUESTIONS**

(3 Min)

#### **1. QUESTIONS FROM THE CLASS**

#### **2. QUESTIONS TO THE CLASS**

**Q.** If the bottom carabiner in a quickdraw is facing left which way should the rope be clipped in?

**A.** From the left.

**Q.** How can parallel sided cracks be overcome in a climb using chocks?

**A.** Stacking.

### **SUMMARY**

(2 Min)

**a.** During this class we have covered the various techniques for placing protection, how to clip into quickdraws and how to rack your gear.

**b.** Those of you with IRF's please fill them in at this time. We will now take a short break.

UNITED STATES MARINE CORPS  
Mountain Warfare Training Center  
Bridgeport, California 93517-5001

SML  
ACC  
02/11/02

**LESSON PLAN**

**BELAYING FOR PARTY CLIMBING**

**INTRODUCTION**

(5 Min)

- 1. GAIN ATTENTION.** In two party climbing it is essential that the belayer is secured to an anchor. If his partner fell, it is possible that the belayer could be dragged up the cliff face or pulled off. On a multi-pitch climb, (a climb which involves a number of belay positions), the climbers must have a set method of securing themselves to the rock face.
- 2. OVERVIEW.** The purpose of this period of instruction is to introduce the students to belaying for party climbing, by demonstrating how to belay and how to tie into all the anchors that are available. This lesson relates to placing protection and two party climbing.

**3. INTRODUCE LEARNING OBJECTIVES**

**a. TERMINAL LEARNING OBJECTIVES**

- 1 )** In a summer mountainous environment and given the necessary equipment, conduct belaying techniques for party climbing, in accordance with the references.

**b. ENABLING LEARNING OBJECTIVES**

- 1 )** Without the aid of references, describe in writing the methods of belays, in accordance with the references.
- 2 )** Without the aid of references, describe in writing the types of belays, in accordance with the references.
- 3 )** Without the aid of references, describe in writing the minimum amount of natural anchors required to create a belay anchor, in accordance with references.
- 4 )** Without the aid of references, describe in writing the minimum amount of artificial protection required to create a belay anchor, in accordance with the references.
- 5 )** In a summer mountainous environment, establish a climbing anchor using natural anchor points, in accordance with the references.

6 ) In a summer mountainous environment, establish an artificial anchor system, in accordance with the references.

4. **METHOD/MEDIA.** The material in this lesson will be presented by lecture and demonstration. You will practice what you have learned in upcoming field training exercises. Those of you with IRF's please fill them out at the conclusion of this period of instruction.

5. **EVALUATION**

- a. SML - You will be tested by a written examination and a performance evaluation.
- b. ACC - You will be tested by a written examination and a performance evaluation.

**TRANSITION:** Are there any questions over the purpose, learning objectives, how the class will be taught, or how you will be evaluated? Let's take a look at belaying concepts

**BODY**

(90 Min)

1. (5 Min) **THE CONCEPT OF BELAYING.** Belaying is the procedure by which the belayer, also known as the #2 climber, manages the rope that is tied to the lead climber, also known as the #1. The following procedures take place during the belay sequence of a climb:
- a. The belayer establishes an anchor system (a strong attachment point to the mountain) and takes a stance (bracing against the terrain to resist a hard pull on the rope).
  - b. Rope is paid out as the climber advances, keeping a minimum of slack between the roped team so that any fall will be stopped as short as possible.
  - c. If the climber falls, the belayer will apply the brake with the use of a belay device.
  - d. Upon reaching the top, the lead climber will establish a belay stance to top rope up the number 2.

**NOTE:** Alertness and appreciation for the importance of the belayer's role is critical. A leader belayed by a novice without the knowledge and training in belay techniques would be wise to climb as if there were no belay at all.

**TRANSITION:** Now that we have discussed the concept of belaying, are there any questions? Let's discuss methods and types of belays.

2. (5 Min) **TYPES OF BELAY ANCHORS.** There are two basic types of belay anchors: Indirect and Direct.

- a. **Indirect Belay.** The term stems from the fact that the belayer's position is between the anchor point and the climber, therefore absorbing some of the Impact Force in the event of a fall. So the force of the fall goes indirectly to the belay anchor point through you.

- b. Direct Belay. The direct belay exerts the Impact Force of a falling climber directly to the belay anchor point. The belayer is not in the system but still remains in control of the belay device.

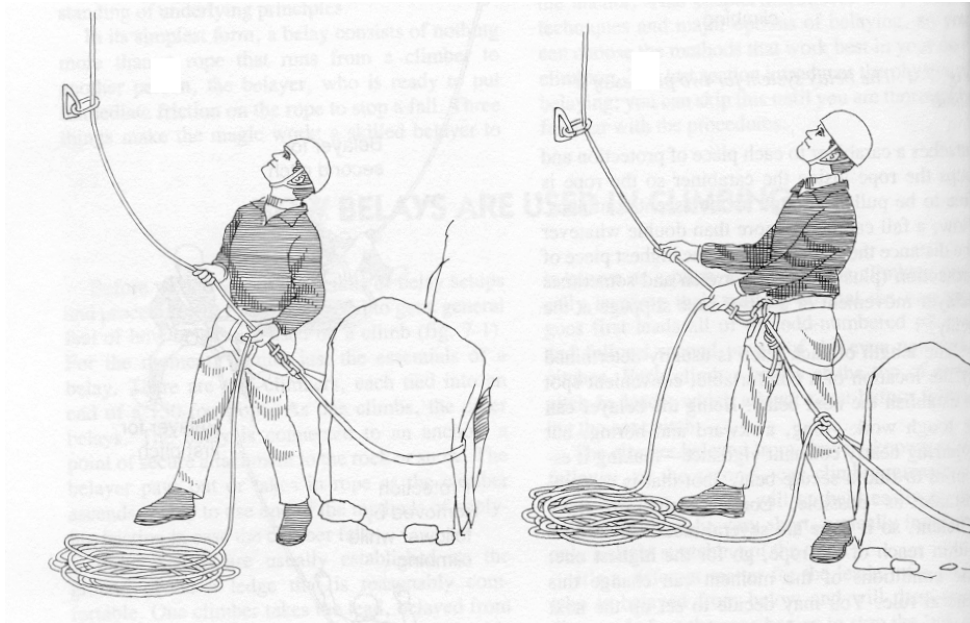

**DIRECT AND INDIRECT BELAYS**

TRANSITION: Now that we have discussed the types of belays, are there any questions? Let's discuss the elements of a belay chain.

3. (5 Min) **ELEMENTS OF A BELAY CHAIN**. There are three principle elements of a belay chain used in rock climbing: the Anchor, the Belayer and the Climber (ABC).

- a. The Anchor. The anchor is a term used to describe the method by which the belayer attaches himself (with the rope or additional equipment) to the mountain so that he cannot be pulled off his belay stance. The anchor can be either an indirect or a direct belay using either natural or artificial points, or a combination of both.

1 ) When using natural anchors during climbing operations, a minimum of two natural anchor points will be utilized.

2 ) When using artificial anchors during climbing operations, a minimum of three artificial anchor points will be utilized.

3 ) If constructing an anchor system in which only one natural anchor can be located for use, it must be backed up by two pieces of artificial protection.

4 ) Anchors on the bottom should normally be behind the belay man and at or below his

waist, terrain permitting. Anchors on the top should be at waist height or above, terrain permitting.

- b. The Belayer. The term belayer is used to describe the static climber's mission of providing security with a rope to the lead climber in case of a fall.

- 1 ) The belayer should position himself as near to the climbing route as possible to prevent the "Zipper Effect". This is covered in *ALTERNATIVE BELAYS AND ANCHORS*.

- 2 ) When using the indirect belay stance, the belayer should secure himself snugly between the anchor and the climber to absorb some of the Impact Force and to prevent any possible dragging, which could possibly jar the brake hand off the rope.

- 3 ) When using the direct belay stance, the belayer should ensure that the anchors could support a Factor Two fall. This is covered in *PARTY CLIMBING*.

- 4 ) When belaying from above, ideally the belayer should try to establish a sitting belay stance.

- c. The Climber. Besides climbing the route, the climber is responsible for:

- 1 ) Places protection into the rock through which the rope is passed through so that in case of a fall, the length of the fall is reduced.

- 2 ) Establishes the top anchor belay to bring up the number 2.

TRANSITION: Now that we have discussed the elements of a belay chain, are there any questions? Let us discuss the establishment of a belay.

- 4. (5 Min) **BELAYER'S RESPONSIBILITIES**. Before establishing a belay stance the belayer must:

- a. Ensure that the anchors are sound and in conjunction with the direction of pull.

- b. Locate the exact position of where he will be belaying the lead climber. This is known as the belay stance.

- c. When possible, the belay stance should be slightly offset from the lead climber's intended route to avoid possible hazards such as falling rocks, equipment, etc...

- d. Ensure that the climbing rope is back stacked near the belay stance.

- e. With his respected end of the climbing rope, tie a retrace figure of eight into the hard point of his harness.

TRANSITION: Now that we have discussed the responsibilities of the belayer before a climb, let us talk about establishing the belay.

**5.** (30 Min) **ESTABLISHING THE BELAY.** A properly designed and secured belay stance is essential if the risk of a serious injury is to be minimized while conducting climbing operations. Whether using natural or artificial anchor points will constitute the design of the belay stance:

**a.** Establishing a Natural Anchor Belay Stance Using the Rope. This method is desired when the anchor points are near by. Minimum amount of equipment is necessary to build this system, but it may require the use of a lot of rope.

**1** ) Approximately three feet from the retrace figure of eight loop on the harness, tie a figure of eight loop.

**2** ) Attach a large steel locking carabiner onto the retrace figure of eight. This will now be referred to as the Main Anchor Carabiner (MAC).

**3** ) Clip the figure of eight loop into the MAC. This will now be referred to as the remote. The remote allows the belayer to escape the anchor system if necessary. This will be covered in *RESCUE FOR PARTY CLIMBING*.

**4** ) From the remote, take a bight of rope and place it around the furthest natural anchor point then back to the belay stance.

**5** ) Ensuring that the rope is taut, tie an over the object clove hitch with the bight of rope and clip it into the MAC.

**6** ) From the clove hitch on the MAC, take a bight of rope and place it around the second natural anchor point then back to the belay stance.

**7** ) Again ensuring that the rope is taut, tie an over the object clove hitch and clip it into the MAC and lock down the carabiner.

**8** ) The climber is now in a secure belay stance. He will sound off with the command "Off Climb".

**9** ) He will now clip another steel locking carabiner into the MAC. This will serve as the belaying carabiner to attach the belaying device to.

**10** ) With the live rope near the lead climber's retrace figure of eight, attach it to the belay device ensuring that the belaying carabiner is locked down when complete.

**11** ) The #2 is now ready to belay the lead climber.

**b.** Establishing a Natural Anchor Belay Stance Using Slings / Runners. Using slings / runners will shorten the distance to the anchors points when they are further away. More equipment will be necessary to build this system, but it may require less rope to construct.



- 1 ) Place a sling / runner around the furthest natural anchor point with a non locking carabiner.
- 2 ) Attach a MAC onto the retrace figure of eight.
- 3 ) With the rope from the retrace figure of eight loop on the harness, attach it to the furthest natural anchor point ensuring that there will be slack in the rope. This will enable him to escape the system if needed.
- 4 ) With the rope from the natural anchor point, return to the designated belay stance.
- 5 ) Ensuring that the rope is taut, tie an over the object clove hitch and clip it into the MAC.
- 6 ) From the clove hitch on the MAC, take the rope and clip it straight through the second natural anchor point and return to the belay stance.
- 7 ) Again ensuring that the rope is taut, tie an over the object clove hitch and clip it into the MAC and lock down the carabiner.
- 8 ) The climber is now in a secure belay stance. He will sound off with the command "Off Climb".
- 9 ) He will now clip another steel locking carabiner into the MAC. This will serve as the belaying carabiner to attach the belaying device to.
- 10 ) With the live rope near the lead climber's retrace figure of eight, attach it to the belay device ensuring that the belaying carabiner is locked down when complete.
- 11 ) The #2 is now ready to belay the lead climber.

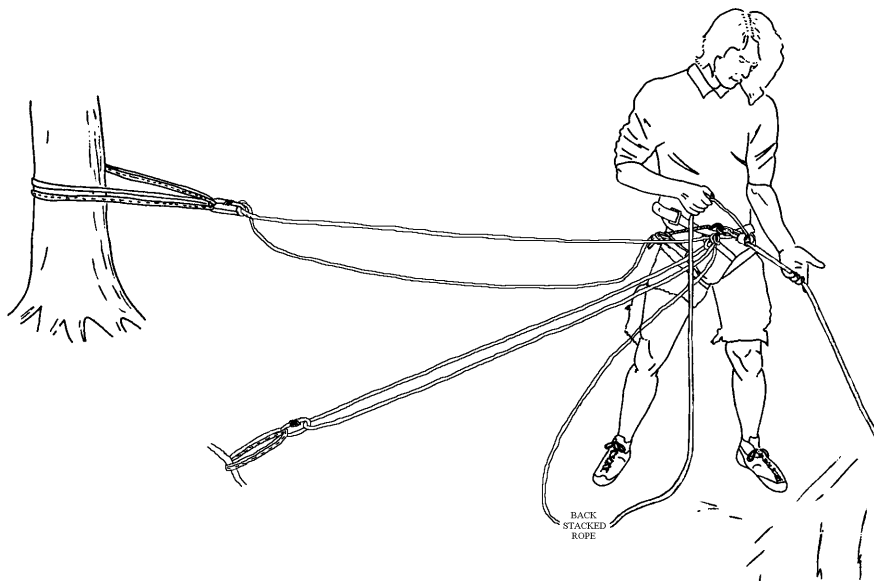

**BELAYING WITH TWO NATURAL ANCHORS USING SLINGS AND RUNNERS**

- c.** Establishing an Artificial Anchor Belay Stance. When no natural anchor points are available, the #2 will establish the belay stance utilizing at least three pieces of artificial protection. All three pieces of protection will be placed in the direction of pull.

**NOTE:** Special considerations for anchors established on ledges and during amphibious assaults will be discussed in *ALTERNATIVE BELAYS AND ANCHORS*.

- 1 ) Place the three pieces of artificial protection into the rock, keeping in mind the anticipated direction of pull if the lead climber fell. Ideally the # 2 would place the three pieces behind him, below the waist and spaced out evenly.
- 2 ) Attach a MAC onto the retrace figure of eight.
- 3 ) With the rope from the retrace figure of eight loop on the harness, attach it to the furthest artificial anchor point with an over the object clove hitch ensuring that there will be slack in the rope that returns to the climber. This will enable him to escape the system if needed.

**NOTE:** Runners and slings are not required but can be used for extension purposes.

- 4 ) With the rope from the artificial anchor point, return to the designated belay stance.
- 5 ) Ensuring that the rope is taut, tie an over the object clove hitch and clip it into the MAC.
- 6 ) From the clove hitch on the MAC, take the rope and clip it straight through the second artificial anchor point and return to the belay stance.
- 7 ) Again ensuring that the rope is taut, tie an over the object clove hitch and clip it into the MAC and lock down the carabiner.
- 8 ) Attach a non locking carabiner into the MAC.
- 9 ) From the second clove hitch on the MAC, take the rope straight through the third piece of artificial protection and attach it to the non locking carabiner on the MAC with an over the object clove hitch.
- 10 ) The climber is now in a secure belay stance. He will sound off with the command "Off Climb".
- 11 ) He will now clip another steel locking carabiner into the MAC. This will serve as the belaying carabiner to attach the belaying device to.
- 12 ) With the live rope near the lead climber's retrace figure of eight, attach it to the belay device ensuring that the belaying carabiner is locked down when complete.

**13** ) The #2 is now ready to belay the lead climber.

**NOTE:** Whenever using artificial protection, slings / runners are not required but can be used for extension purposes. Always keep in mind not to disturb the direction of pull when using slings / runners.

- d.** Establishing an Anchor Belay Stance using both Natural and Artificial Anchors. If constructing an anchor system in which only one natural anchor can be located for use, it must be backed up by two pieces of artificial protection. The method of constructing this system will be the same as constructing an artificial anchor belay stance.

**TRANSITION:** Now that we have discussed how to establish a belay stance, are there any questions? Let us now talk about methods of belaying a fall.

**6.** (5 Min) **METHODS OF BELAYING A FALL.** There are two methods of belaying a lead climber's fall: Static and Dynamic.

**a.** Static Belay.

**1** ) A static belay is a method, which does not allow the rope to run through the belay device, therefore stopping the falling climber quickly. The belayer brakes immediately after the fall occurs, therefore preventing any unnecessary slack developing between himself and the climber.

**2** ) This technique is used when the belay anchor points, and the running belays are sound. It is also used to stop a falling climber from hitting any projection (a ledge or rock outcrop) that is below him when he falls. This is the most common belay used on rock.

**b.** Dynamic Belay.

**1** ) A dynamic belay is a method, which deliberately allows some of the rope to run through the belay device, thus slowly bringing the falling climber to a halt. The belayer will gradually apply braking pressure to the rope to reduce the Impact Force on the belay anchor points and the running belays.

**2** ) This technique is used when the belay anchor points and the intermediate points of protection are not very sound. It is mostly used when ice climbing, although the technique is widely used when climbing unstable rock.

**TRANSITION:** Now that we have talked about the methods to belay a fallen climber, let us discuss the disassembly of the belay stance.

**7.** (5 Min) **DISASSEMBLY OF THE BELAY STANCE.** Upon hearing the command "Off Climb" from the lead climber, the #2 will:

- a. Remove the live rope from the belay device and wait until the next command of “Up Rope”.
- b. The lead climber will pull up the rope until it becomes taut against the MAC of the #2.
- c. The #2 will give the command “That’s Me”. This informs the lead climber to secure the rope to his belay device.
- d. After securing the climbing rope to his belay device, the lead climber will give the command “On Belay”.
- e. The #2 will now disassemble the belay stance in reverse order of the way it was constructed. Ensuring that lead climber continues to take the slack out of the rope after each anchor removed.
- f. After all the anchors have been removed, the #2 will ensure that all the gear is stowed properly and that the nut pick is readily available.
- g. The #2 will now give the command “Climbing”.
- h. The lead climber will answer back with the command “Climb Climber”.
- i. The #2 will begin to climb. At this time, the roles are switched. The belayer will become the climber and the lead climber will become the belayer.

TRANSITION: Now that we have discussed the disassembly of the belay stance, are there any questions? Let us now talk about retrieving the protection.

8. (5 Min) **RETRIEVING THE PROTECTION.** While the #2 is climbing, he will retrieve all the pieces of protection along the route. The following are the actions of the #2 during his ascent:
  - a. When the he reaches a piece of protection, he will sound off with the command “Point”, this informs the belayer to set the brake with the belay device.
  - b. The belayer will answer back with the command “Point”, to ensure the climber that he has set the brake.
  - c. The #2 will remove the protection and stow it away on his rack. If the piece of protection becomes difficult to remove, he will utilize the nut pick.
  - d. After stowing the protection, he will sound off with the command “Climbing”, this informs the belayer that he has removed the protection and that it has been properly stowed.
  - e. The belayer will answer back with the command “Climb, Climber”, this informs the

climber that he is ready to begin belaying procedures.

- f. The #2 will repeat these actions until he tops off.
- g. When the #2 reaches the belay position, he will either:
  - 1 ) Make himself secure by moving 10 feet back for the edge of the climb or attach himself to an anchor point.
  - 2 ) Stop and exchange/reorganize climbing gear with the lead climber for next pitch, and then continue climbing.

TRANSITION: Now that we have discussed retrieving the protection, are there any questions? Multi-pitch climbs require the belayer to establish a belay stance during the climb. Let us now talk about the belay method known as hanging belays.

9. (10 Min) **ESTABLISHING A HANGING BELAY STANCE.** Multi-pitch climbs require the climber to establish a belay stance midway through the climb. Since it takes approximately 15 feet of rope to construct a hanging belay, constant awareness of the amount of rope used during the climb must be acknowledged. This can be accomplished through communications between the climber and the belayer. Constructing the hanging belay stance is basically the same as an artificial anchor belay stance with a few considerations.
- a. When the belayer has approximately 25 feet of live rope left to pay out to the climber, he will sound off “Twenty Five Feet”. This informs the climber to begin looking for a belay stance.
  - b. The climber will begin to locate a good position to establish the hanging belay stance understanding that he will use approximately 10 to 15 feet of rope to construct the belay stance.
  - c. Once a position has been located he will sound off with the command “Point”, this informs the belayer to set the brake with the belay device.
  - d. The belayer will answer back with the command “Point”, to ensure the climber that he has set the brake.
  - e. The climber will begin to construct his belay stance by placing a piece of protection in the downward direction of pull at approximately chest level to the climber or higher, but within arms reach.
  - f. With the rope from the retrace figure of eight loop on the harness, attach it to the piece of protection with an over the object clove hitch.
  - g. The climber will attach a MAC onto the retrace figure of eight.
  - h. Ensuring that the rope is taut from the piece of protection, tie an around the object clove

hitch and clip it into the MAC.

- i. The climber will place a second and third piece of protection, again in the downward direction of pull at approximately chest level to the climber or higher, but within arms reach.
- j. From the clove hitch on the MAC, the climber will take the rope and clip it straight through the furthest piece of protection and again ensure that the rope is taut, attach it on to his MAC with an around the object clove hitch and lock down the carabiner.
- k. The climber will now attach a non-locking carabiner into the MAC.
- l. From the second clove hitch on the MAC, the climber will take the rope straight through the third piece of protection.
- m. Again ensuring that the rope is taut, attach it to the non-locking carabiner on the MAC with an over the object clove hitch.
- n. The climber now will place his fourth piece of protection in the upward direction of pull at approximately waist level to the climber or lower, but within arms reach.

**NOTE:** The principle behind this is so that when the #2 climber passes the belay stance and becomes the lead climber, this fourth piece of protection will prevent the belayer from being pulled upward if the leader falls.

- o. From the clove hitch on the non-locking carabiner, take the rope and attach it to the fourth piece of protection with an over the object clove hitch.
- p. The climber is now in a secure belay stance. He will sound off with the command “Off Climb”.
- q. He will now clip another steel locking carabiner into the MAC. This will serve as the belaying carabiner to attach the belaying device to.
- r. The climber will pull up the rope, ensuring to back stack it carefully to prevent unnecessary entanglement.
- s. Once the climber receives the command “That’s Me”, he will attach the live rope to the belay device ensuring that the belaying carabiner is locked down when complete.
- t. The climber is now ready to belay his partner and will sound off with the command “On Belay”.

**TRANSITION:** Now that we discussed hanging belay, are there any questions? Let us now discuss the changing over of gear during a climb.

**10.** (5 Min) **CHANGING OVER GEAR.** The most efficient method of multi-pitch climbing is

for a pair of climbers to alternate leading pitches. At each belay stance the climbers will have to change over and reorganize the gear for the next pitch. When the #2 climber reaches the belay stance, the #1 climber will tie off the belay device and connect a web runner from his donut to the #2 climber's donut. Now the #2 climber is effectively secured so that the gear can be changed over.

TRANSITION: Are there any questions over changing over the gear? With the basics you have learned you should have little trouble in understanding the mechanics of an effective belay. If you have no questions for me, then I have some for you.

**PRACTICE** (CONC)

- a. The students will practice establishing anchors.

**PROVIDE HELP** (CONC)

- a. The instructors will assist the students when necessary.

**OPPORTUNITY FOR QUESTIONS** (3 Min)

1. QUESTIONS FROM THE CLASS

**2. QUESTION TO THE CLASS**

**Q.** What is the minimum number of anchors used in a natural anchor?

**A.** Two.

**Q.** What is the minimum number of anchors used in an artificial belay anchor?

**A.** Three.

**SUMMARY** (2 Min)

a. We have discussed belaying considerations, types of belays, methods of belays, components of a belay chain, the methods of anchoring, and how to tie in to the anchors.

b. Those of you with IRF's please fill them out and turn them in to the instructor. We will now take a short break.

**UNITED STATES MARINE CORPS**  
Mountain Warfare Training Center  
Bridgeport, California 93517-5001

SML  
ACC  
02/19/02

**LESSON PLAN**

**PARTY CLIMBING**

**INTRODUCTION**

(5 Min)

- 1. GAIN ATTENTION.** Two party climbing is the means by which trained military mountaineers ascend vertical to near vertical rock features, without the benefit of a top-rope. In the military, party climbing is used as a means of ascending a cliff face to set up ropes and other associated installations from the top of a rock feature, to prepare the way for a unit to undertake a cliff assault, or as a means of crossing an obstacle.
- 2. OVERVIEW.** The purpose of this period of instruction is to introduce the student to the method of two party climbing, as well as an understanding of fall factors. This period of instruction brings together placing protection, anchor belays for party climbing, and the balance climbing class. This lesson relates to cliff assault.
- 3. INTRODUCE LEARNING OBJECTIVES**
  - a. TERMINAL LEARNING OBJECTIVE.**
    - 1 )**In a summer mountainous environment and given the necessary equipment, two party climb a rock face, in accordance with the references.
  - b. ENABLING LEARNING OBJECTIVES**
    - 1 )**In a summer mountainous environment and given the necessary equipment and a designated cliff face, lead a party climb, in accordance with the references.
    - 2 )**In a summer mountainous environment and given the necessary equipment and a designated cliff face, belay a party climb, in accordance with the references.
    - 3 )**In a summer mountainous environment, execute climbing commands for party climbing, in accordance with references.
    - 4 )**Without the aid of references, list in writing the dangers to avoid for route selection in party climbing, in accordance with the references.



5) Without the aid of references, list in writing the responsibilities of a lead climber prior to a climb, in accordance with the references.

6) Without the aid of references, list in writing the times you would place protection, in accordance with the references.

4. **METHOD/MEDIA.** The material in this lesson will be presented by lecture and demonstration. You will practice what you have learned in upcoming field evolutions. Those of you with IRF's please fill them out at the end of this lesson and return them to the instructor.

5. **EVALUATION**

a. SML - You will be tested by a written exam and a performance evaluation.

b. ACC - You will be tested by a written exam and a performance evaluation.

TRANSITION: Are there any questions over the purpose, learning objectives, how the class will be taught, or how you will be evaluated? Before a climb can start we need a belay.

**BODY**

(75 Min)

1. (5 Min) **THE BELAY.** Where a belayer chooses to establish his belay is an important consideration. It is possible that the belayer may sit or stand for hours on end so a position of comfort should be chosen. There are two basic stances, sitting and standing. Normally sitting is used on the top anchor and standing on the bottom.

TRANSITION: Now that we have talked a little about the belay, let's now look at some dangers to avoid when party climbing.

2. (5 Min) **DANGERS TO BE AVOIDED WHEN SELECTING A ROUTE**

a. Wet or Icy Rock. These impediments can make an otherwise easy route almost impassable.

b. Rocks overgrown with moss, lichen, or grass. These areas can be very treacherous when wet or dry.

c. Tufts of grass and small bushes growing from loosely packed soil. These normally appear firm, but can give way suddenly when they are pulled or stepped on.

d. Gullies that are subject to rock fall. If you have to use a gully that has evidence of rock fall in it, then try to stay to the sides.

e. The most common danger is the overestimation of your own ability.

TRANSITION: Once at a cliff face, it is imperative that we keep in mind our responsibilities in order to maintain organization.

**3.** (5 Min) **LEAD CLIMBERS RESPONSIBILITIES**. Before starting a climb the lead climber must:

- a.** Pre-select probable route.
- b.** Ensure he has the proper equipment to complete the route.
- c.** Ensure that the climber and the #2 are tied into their respective ends of the rope.
- d.** Ensure that the #2 has selected the proper anchors for the belay anchor system.
- e.** The lead climber may have to construct a gear rack to carry his equipment on. It is constructed as follows;

**1**) Take a length of 1 inch tubular nylon webbing and tie the ends together using a water/tape knot forming a loop so it fits over your head and shoulder and runs diagonally across your chest. If tubular nylon webbing is not available, then utilize one of your runners, if the route will permit. A sling rope could also be used as a gear rack.

TRANSITION: Now that we have covered dangers to be avoided when selecting a route, are there any questions? As we climb, and we have all of this gear on our body, we need to know when and where to place our pro.

**4.** (10 Min) **RULES FOR PLACING PRO**. In the placing protection class the method of placing protection was covered; however, there are four rules for placing pro. These are as follows:

- a.** First runner rule. A good piece of protection should be placed as high as possible just before leaving the ground to prevent hitting the ground in a fall. Once that first piece of pro is at waist level, a second piece should be placed as high as possible. A third piece should be placed following the same guidelines as the second piece (this will reduce the chances of the leader bottoming out).
- b.** Every 10 to 15 feet. This is done to prevent the possibility of taking a long fall. On a short route, 30 to 50 feet, protection should be placed every six to eight feet to prevent bottoming out during a fall.

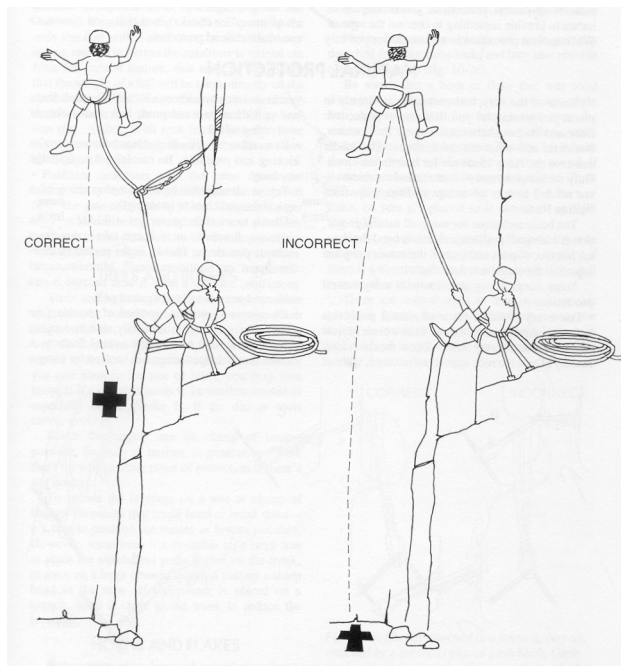

**BOTTOMING OUT DUE TO NO PROTECTION**

- c.** Before and after a hard move. A leader should place pro before and after a hard move (crux) because a fall is more likely. If you are not satisfied with that piece of pro, back it up with another one. If a ledge is encountered during a climb, the first runner rule will apply again.

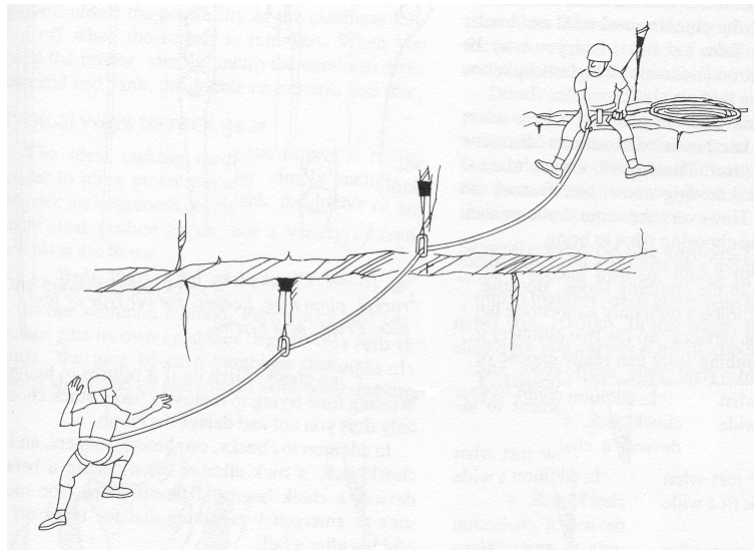

**PLACING PROTECTION BEFORE AND AFTER A HARD MOVE**

- d.** When the climber feels that protection needs to be placed. When in doubt - stitch the route.
- e.** When placing a number 1 or number 2 stopper, always backup these pieces of protection with a secondary piece as soon as possible.

**5.** (5 Min) **PREVENTING ROPE DRAG.** Rope drag causes all sorts of problems. It can hold a climber back, throw him off balance, pull his pro out, and can make it hard for the leader to pull enough rope up to clip the next piece of protection. Also, rope drag can affect how well a belayer responds to a fall by reducing the ability to provide a dynamic belay. Keeping the rope in a straight line from the belayer to the climber is the best way to reduce rope drag.

**a.** Pro Placement.

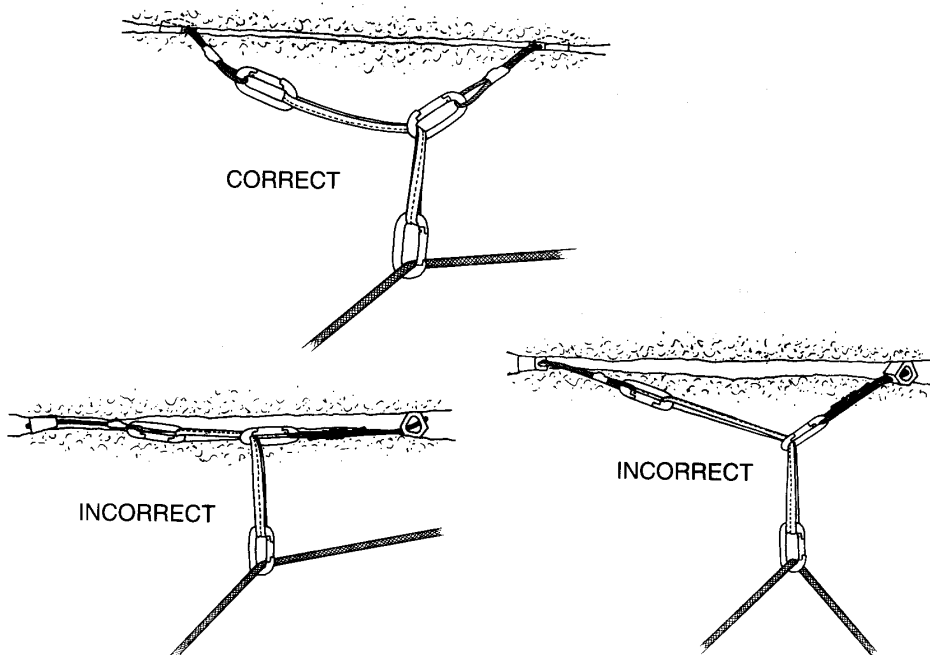
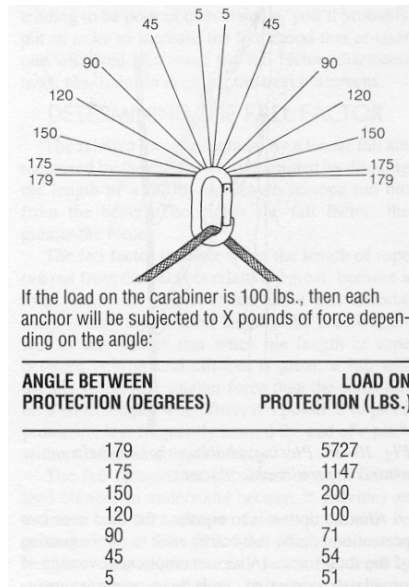

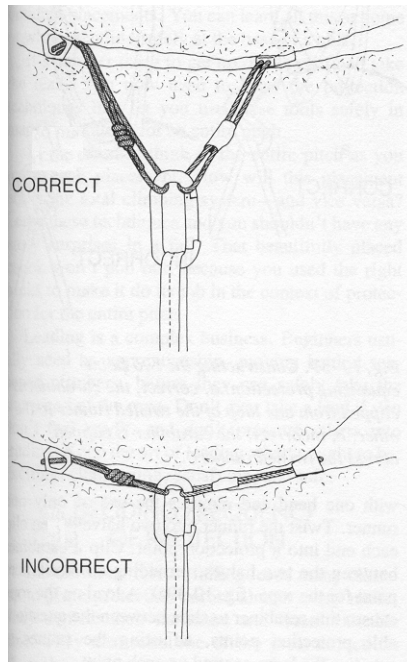

- b.** Runners / Quick draws. Protection should be placed so that the rope follows as straight of a line as possible. If the protection placements do not follow a straight line up the pitch, and the rope is clipped directly to these placements, it will zigzag up the cliff, causing severe rope drag. If the protection cannot be placed in a direct line, runners or quick draws can be used to extend the protection. This will allow the rope to hang straight and run more freely through the protection system.

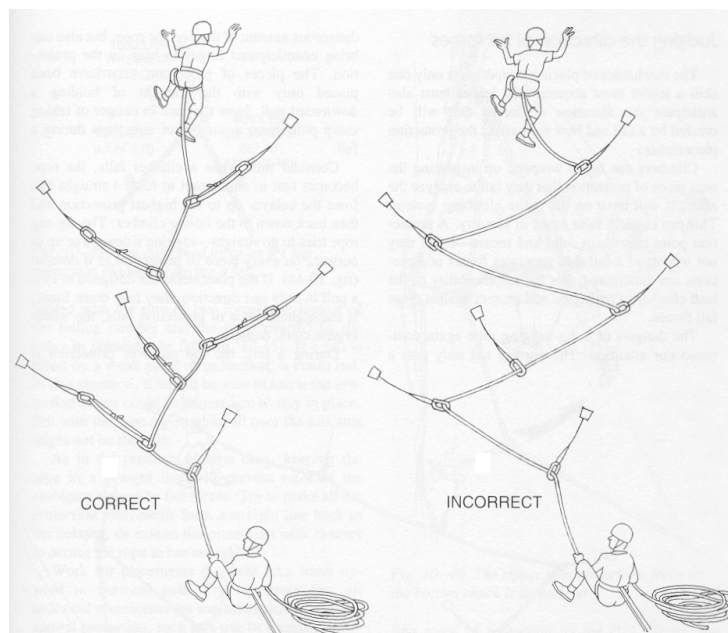

**USE OF RUNNERS TO PREVENT ZIG-ZAGGING OF ROPE**

- 1**) If you use an extra long runner you can create another problem. The extension may

keep the rope in a straight line, but it may also add dangerous extra feet to the length of a fall. In such a case, it is sometimes better to accept some rope drag in order to get better security in case of a fall.

- 2) If the protection placements happen to be in a straight line, the rope will run straight and there will be less rope drag even if it is clipped directly to the protection. However, you must be aware that rope movement can and will jiggle a chock out of position. So a quick draw can be used to isolate the pro from rope movement.
- 3) Quick draws should always be placed on wire protection and SLCD's without pre-sewn runners that are used for running belays. There is no requirement to place quick draws on wire runners used for a belay stance, unless you need some extension.

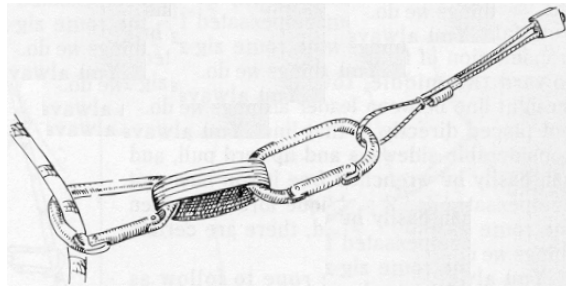

**QUICK DRAW ON A PIECE ON WIRE PROTECTION**

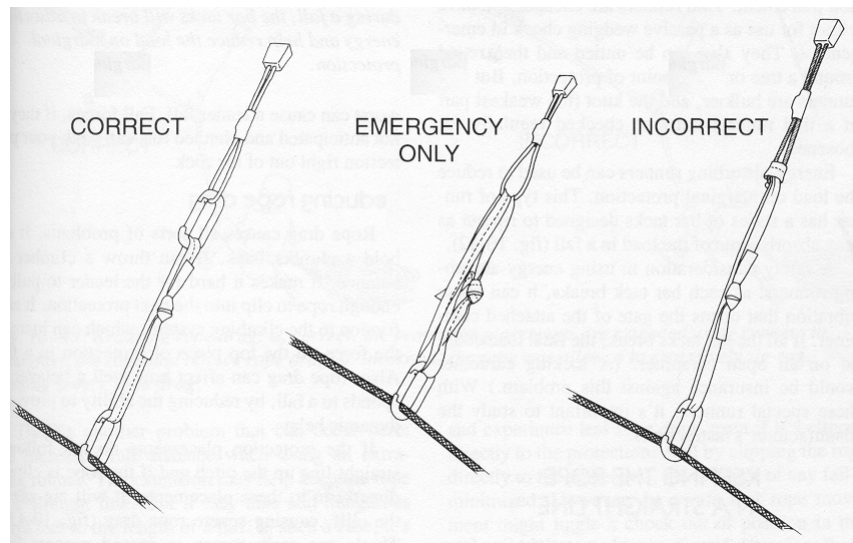

**QUICKDRAWS ON PROTECTION**

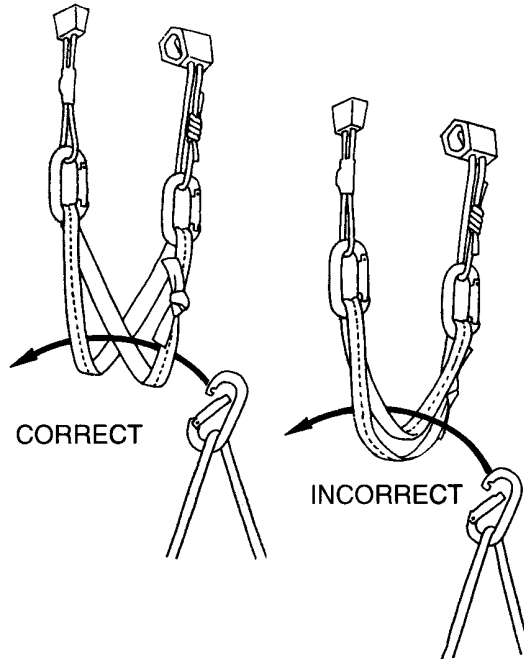

**PROPER PLACEMENT OF CARABINER THROUGH A RUNNER  
ON MULTIPLE PIECES OF PRO**

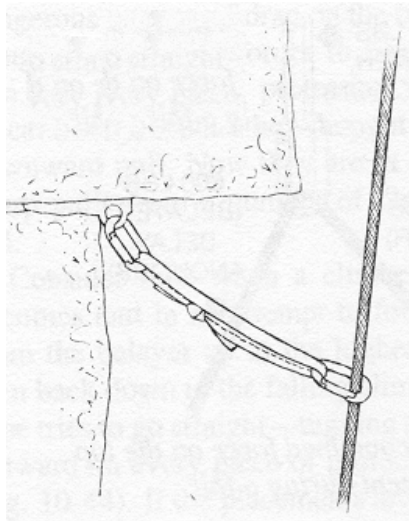

**PROPER ROPE PLACEMENT  
AND RUNNER LENGTH**

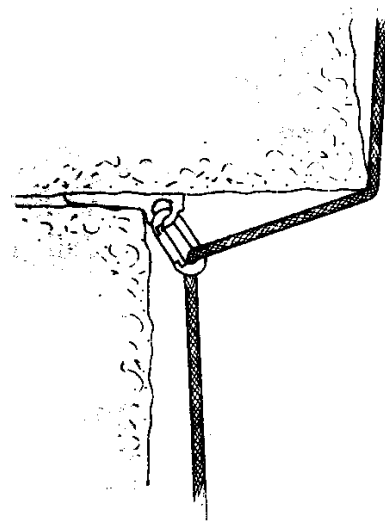

**CARABINER THAT NEEDS A  
RUNNER AND CARABINER TO  
REDUCE ROPE FRICTION**

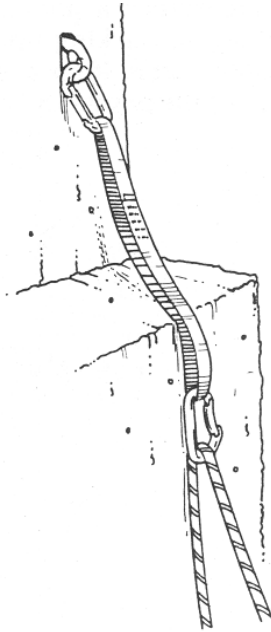

**CORRECT RUNNER LENGTH**

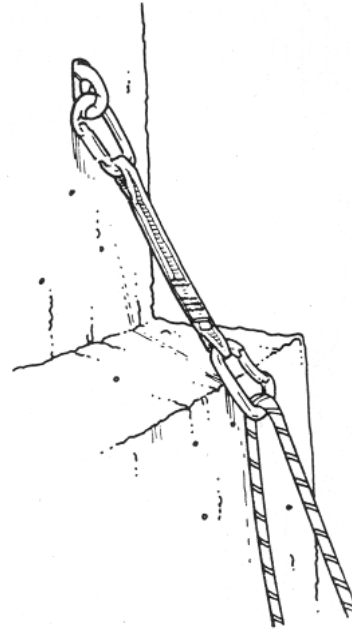

**INCORRECT RUNNER LENGTH**

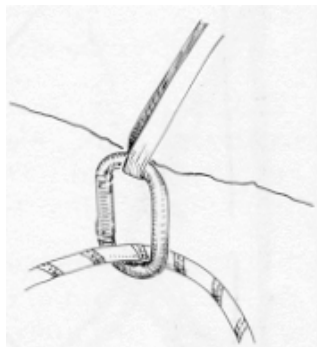

**CORRECT PLACEMENT OF CARABINER ON AN EDGE**

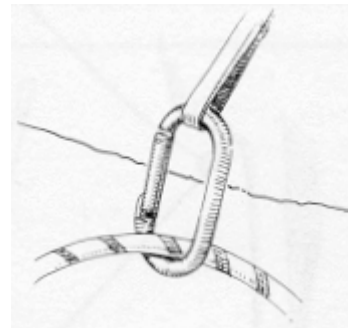

**INCORRECT POSITION OF CARABINER ON AN EDGE**

4 ) Quick draws do not need to be placed on corded hexcentrics or chocks unless you need extension.

**6. (10 Min) CONSIDERATIONS FOR PARTY CLIMBING**

- a. A two man climbing team is faster than a three-man team is.
- b. The strongest climber of a team always takes the hardest pitch.
- c. Climbers will tie into their harnesses with a retrace figure-of-eight; they will not untie until they are off the climb, 10 ft back away from the cliff edge, or secured to an anchor point.
- d. As you climb you must use the correct climbing commands to prevent confusion.



- e. Where possible, the leader should use natural anchors for protection.
- f. The leader must not climb to the length of the rope before selecting a good belay stance, ideally 15 feet of rope is required for a belay anchor.
- 1) When the lead climber reaches a good position, he will set up a belay position and bring up the #2 climber.
- g. If a traverse is encountered it is protected as shown. The leader is not only protecting himself but also the #2 man as well.

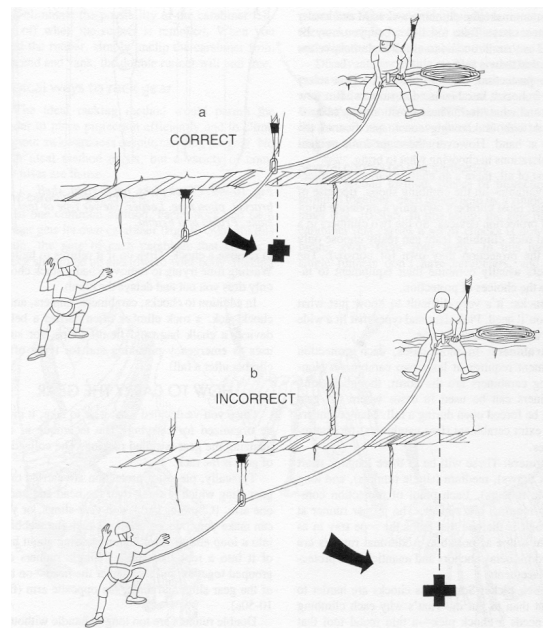

**PRO PLACEMENT FOR TRAVERSING**

**NOTE:** Protecting a traverse: A: correct, placing protection after a hard move and a traverse can reduce the potential pendulum fall for the second climber. B: incorrect, if the second climber falls on the traverse with inadequate protection, he faces a long pendulum fall.

**TRANSITION:** Now that we have discussed rules for placing pro, preventing rope drag and considerations for party climbing, are there any questions? Next we'll talk about the climbing commands used when party climbing.

**7.** (10 Min) **CLIMBING COMMANDS.** During a climb you will often find yourself in a position where you cannot see your climbing partner. This accompanied by the effects of wind, weather conditions or the distance between each other, often makes communication very difficult. For this reason we use a very strict set of commands in order to communicate with as little confusion as possible.

**a.** Verbal Commands

<b>Command</b>	<b>Given By</b>	<b>Meaning</b>
“On Belay”	Belayer	I have a solid anchor, and am ready for you to climb.
“Climbing”	Climber	I am ready to begin the climb.
“Climb”	Belayer	Go ahead.
“Point”	Climber	I have reached a point where I am going to place protection, watch me.
“Point”	Belayer	I am watching, giving or taking rope as needed.
“25 feet”	Belayer	The climber has 25 feet of rope left, and must find a belay stance soon.
“FALLING”	Climber	The climber is about to fall.
“Slack”	Climber	Pay out some rope.
“Slack”	Belayer	Allows climber to take rope that is needed.
“Tension”	Climber	Telling belayer to take up excess rope.
“Tension”	Belayer	I am taking up excess rope.
“Off climb”	Climber	I am at the next belay and I am anchored.
“Off Belay”	Belayer	I have taken off the belay.

**NOTE:** At this point the belayer becomes the number 2 climber and the lead climber is the belay man.

<b>Command</b>	<b>Given By</b>	<b>Meaning</b>
"Up Rope"	#2 (Climber)	Take up excess rope between us
"That's me"	#2 (Climber)	The Climber is ready to be put on belay and the rope is taut on the climber and not snagged
"On Belay"	No 1 (Belayer)	I am in the belay stance and I am ready for you to climb

**NOTE:** From this point on the commands are the same as before.

- b.** Non-verbal Commands. When undertaking a tactical cliff assault the use of verbal climbing commands are not of much use. To that end the climbing pair utilize a method of sharp tugs on the rope to communicate with each other. These are as follows:

<b>Command</b>	<b>Meaning</b>
1 Tug	Give me slack
2 Tug	Give me tension.
3 Long Tugs	I am secured on the belay/the rope is secure.

**NOTE:** Practice of the above Tug commands is essential, as during the normal course of a climb the rope will move around in the belayer’s hand and can deceive the belay man.

**TRANSITION:** Now that we have discussed climbing commands, are there any questions? Without adequate communications, conducting a two-party climb can be extremely dangerous to both parties. With an understanding of belays, it is important to realize that during a multi-pitch climb the leader can fall beyond his belay man without hitting the ground, therefore it is important to learn about the forces exerted in such a fall.

- 8.** (10 Min) **FALL FORCES.** The general standard of climbing equipment is continually being improved. In the event of a fall by a lead climber, an enormous amount of force is applied on

the rope. As the rope stretches, part of the energy converted into heat by the friction between the rope fibers. There are two parts in determining the force of a fall, Impact Force and Fall Factor.

- a. Impact Force. (Shock Force) This is the amount of force the belay man has to exert on a falling climber through the rope, anchor and belay device to stop his fall. The amount of impact force needed to stop his fall is determined by the fall factor.

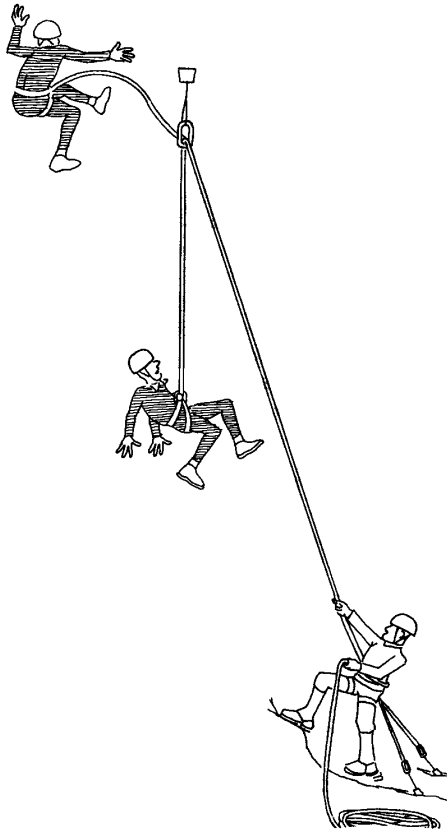

#### IMPACT (SHOCK) FORCE

- b. Fall Factor. This is the amount of force generated by a leader fall onto the rope. A fall factor is purely a mathematical equation, which its numeric result ranges between 0 at the lowest and 2 at the greatest. Fall factor is simply the length of the fall divided by the rope run out. The equation looks like this:

$$\text{Fall Factor} = \frac{\text{Length of Fall}}{\text{Rope Run Out}}$$

#### Example #1

10 meter run out above a belay on a rock face results in a 20 meter fall. (10 x 2)

20

10 = 2 Fall Factors, the highest Fall Factor.

**Example #2**

10 meter run out above a belay on a rock face, but with a piece of protection placed at 5 meters resulting in a 10 meter fall. (5 x 2)

10

10 = 1 Fall Factor

**Example #3**

10 meter run out above a belay on a rock face, but with a piece of protection placed at 7.5 meters resulting in a 5 meter fall. (10 - 7.5) = 2.5 x 2 = 5

5

10 = 0.5 Fall Factor

**FALL FACTOR EXAMPLES**

- c.** The following table shows the relationship of Fall Factor and Impact Force for a 180-pound climber:

<b>RELATIONSHIP OF FALL FACTOR AND IMPACT FORCES FOR 180 LB CLIMBER</b>			
FALL FACTOR	IMPACT FORCE	FALL FACTOR	IMPACT FORCE
0.0	360 lbs	1.0	1676 lbs
0.1	683 lbs	1.2	1817 lbs
0.2	868 lbs	1.4	1947 lbs
0.4	1137 lbs	1.6	2067 lbs
0.6	1347 lbs	1.8	2181 lbs
0.8	1521 lbs	2.0	2288 lbs

**NOTE:** The less a climber weighs, the less Impact Force the belay has to sustain. The more the climber weighs, the more force is exerted

- d.** There are several points that should be considered during a climb to minimize the seriousness of a fall:

**1.)** The belayer must always be in a position to withstand an impact force of 2300 lbs.

**2.)** Protection should be placed more frequently during the first half of the climb.

3 ) It is better to belay after a series of cruxes than before them. Belays after cruxes minimize Fall Factors in potentially dangerous situations.

4 ) A seat harness should always be used to distribute the forces of a fall.

5 ) Any fall involving a Fall Factor in excess of 1.0 should be regarded as serious and the rope should be retired from lead climbing duties.

TRANSITION: We have discussed how to party climb and the considerations for Fall Forces, now let's talk about tactical considerations for military operations.

**9. (5 Min) CONSIDERATIONS FOR NIGHT PARTY CLIMBING AND GEAR SILENCING**

- a. Try to get eyes on the cliff and complete a cliff sketch before nightfall in order to study the terrain and probable route.
- b. All considerations for party climbing apply at night.
- c. Non-verbal commands should be applied.
- d. Get rid of all belay devices to reduce noise, use the Munter hitch for belaying.
- e. Place tape around carabiners to reduce noise, but ensure it does not interfere with gate operation.
- f. If using Hexcentrics, tape the sides and ends of size 6-11 hexes to muffle the echoing effect when they bang together.
- g. Use 550 cord attached to the nut pick to extend it from your chest pocket.
- h. NVG's should be used on the bottom and top of the cliff to help with accountability.

TRANSITION: Up to this point, we have talked about the dangers to avoid when selecting a route, lead climbers responsibilities, rules for placing protection, climbing commands, night party climbing, gear silencing and Fall forces. Are there any questions? If you have none for me, then I have some for you.

**PRACTICE** (CONC)

- a. Students will set an anchor, belay and lead a party climb.

**PROVIDE HELP** (CONC)

- a. The instructors will assist the students when necessary.

**OPPORTUNITY FOR QUESTIONS**

(3 Min)

- 1. QUESTION FROM THE CLASS
- 2. QUESTIONS TO THE CLASS

**Q.** What dangers should be avoided when selecting a route?

**A.** (1) Wet or icy rock.

- 2 )Rocks overgrown with moss, lichen or grass.
- 3 )Tufts of grass/small bushes growing from loosely packed soil.
- 4 )Gullies that are subject to rock fall.
- 5 )The most common danger is overestimation of your ability.

**SUMMARY**

(2 Min)

- a.** During this period of instruction we have discussed the dangers to avoid in party climbing, four responsibilities of a lead climber, climbing commands, when you place pro and Fall Forces.
- b.** Those of you with IRF's please fill them out and pass them to the instructor. We will now take a short break.

UNITED STATES MARINE CORPS  
Mountain Warfare Training Center  
Bridgeport, California 93517-5001

SML  
ACC  
02/19/02

**LESSON PLAN**

**MILITARY AID CLIMBING**

**INTRODUCTION**

(5 Min)

1. **GAIN ATTENTION.** Occasionally, a military climber may find himself up against a rock barrier, which has insufficient handholds, or foot holds to climb or that the technical grade is above what he can climb. One way or another, the climber has to get to the top of the cliff in order to complete the mission. Utilizing aid techniques can get a climber through a tough section where he would normally be stuck and unable to continue.
2. **OVERVIEW.** The purpose of this period of instruction is to introduce to the student military direct aid, by discussing and demonstrating aid climbing, as well as the equipment and techniques used. This lesson relates to party climbing.
3. **INTRODUCE LEARNING OBJECTIVES**
  - a. **TERMINAL LEARNING OBJECTIVE.** In a summer mountainous environment, conduct military aid climbing, in accordance with the references.
4. **METHOD/MEDIA.** The material in this lesson will be presented by lecture and demonstration method. You will practice what you have learned in upcoming field training exercises. Those of you with IRF's please fill them out at the end of this period of instruction.
5. **EVALUATION.** This period of instruction is a lesson purpose class.

**TRANSITION:** Are there any questions over the purpose or how the class will be taught? Before discussing how to military aid climb, we will talk about what aid climbing actually is.

**BODY**

(50 Min)

1. (5 Min) **INTRODUCTION TO AID CLIMBING.** A free climber depends entirely on his footwork, ability, skills and physical strength to move up the rock face. The equipment used while free climbing is for safety; i.e., protection. Equipment is not used to ascend the rock directly. If you were to place a piece of pro and hang on it, or use it to reach a higher hold, you would not be free climbing in the "pure" sense of the word. Any use of equipment to directly ascend a rock face is called aid.

TRANSITION: Next we will discuss situations which may require direct aid.

2. (5 Min) **REASONS FOR AID.** There are many situations, which a military climber may choose to aid, let's name a few.
  - a. Above your ability. You conducted the cliff recon and picked a route, which appeared to be within your ability. Now you're 2 pitches up and stuck.
  - b. Fatigue or Injury. The route may be a simple 5.6, but due to it being sustained 5.6 the entire pitch and not just one 5.6 move, you transition to aid due to fatigue. You take a lead fall on the second pitch and injure your arm or leg. As long as you have one good arm and leg you can continue on, utilizing aid techniques.
  - c. Weather. You arrive at the cliff site and it begins to rain or snow. Aid can be accomplished with gloves on, even when wearing ski march or ice boots.
  - d. Save Energy for Mission or Rescues. As an assault climber, conducting a cliff assault is just a means of crossing an obstacle, in route to the objective. Once your Company or Platoon is up the cliff, you still need the energy to continue on with the mission. In the event of a TRAP mission or high angle rescue, the real work begins once the casualty is down off the cliff, and must be carried to the extract zone.

TRANSITION: Now that we have discussed reasons direct aid may be applied, are there any questions? Let's talk about some of the gear we'll be using.

3. (15 Min) **GEAR FOR MILITARY AID CLIMBING.** Some specialized gear is required for military aid climbing however; this gear can be constructed from the equipment a climbing team already possesses. The three minimum pieces of aid equipment are the Etrier, Daisy Chain and Fifi Hook.
  - a. Etrier. Also known as Aiders. These are ladder like slings that allow climbers to step up from one placement to the next when they are clipped into a piece of pro. Etriers become your hand and footholds on otherwise unclimbable rock. The etriers can be constructed from an 18 foot tape or 21 foot prussic cord (tied in a loop with a square knot). At the top of the web/cord, tie a two-inch loop with an overhand knot. 10 to 12 inches down from the overhand pinch the two strands of web/cord together and pull up one side until it is offset enough for a comfortable step. Tie another overhand knot and repeat the process for the entire length of the web/cord. It is important to alternate which side is offset so that all the steps are not on one side. An 18-foot tape should provide 6 or 7 steps.



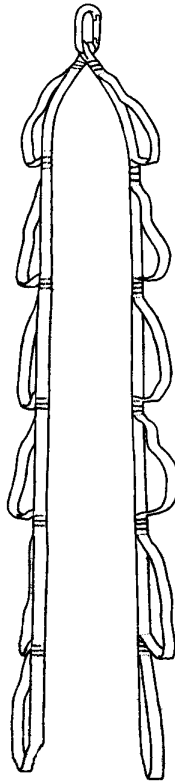

**PRE- SEWN ETRIERS**

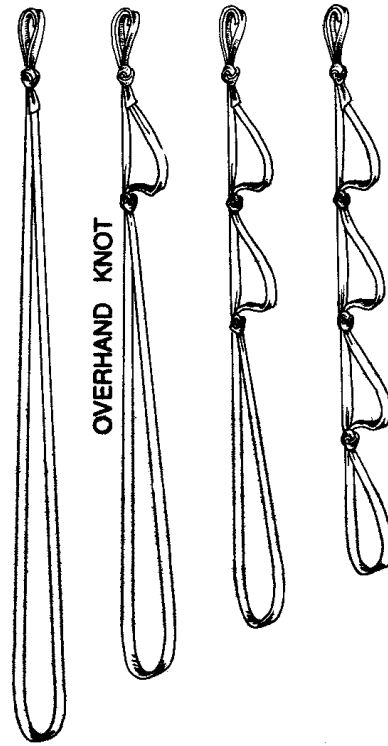

**ETRIER MADE WITH OVERHAND**

**KNOTS**

- b. **Daisy Chain**. A length of webbing or cordage with clip in loops along its entire length used to connect a climber to a piece of pro. A daisy chain can be made from a 48-inch web runner. It is constructed in a similar manner as an etrier however; all the loops should be only 3 to 6 inches apart and on the same side. Keep in mind that the daisy chain should not extend beyond arm's reach.

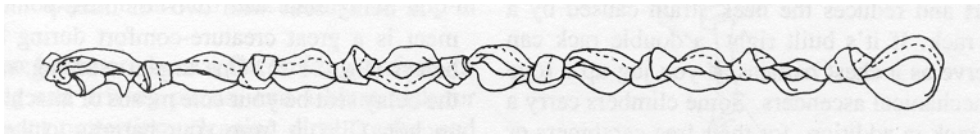

**DAISY CHAIN**

- c. **Fifi Hook**. The fifi hook also called the “Arm Saver”, is used by the lead climber to clip in short from his harness to the next piece of pro after ascending the etrier. This allows the climber to rest his arms while assessing the next placement and sorting through his rack. The actual fifi hook is not part of the MAC Kit but can be made by girth hitching a small runner to the hardpoint of your harness and clipping a carabiner to it.

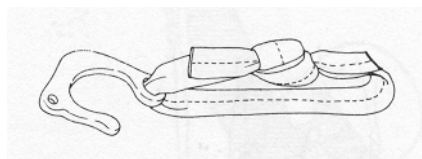

### **FIFI HOOK**

**TRANSITION:** Let's take a minute to look at the Aid Rack.

4. (5 Min) **THE RACK.** If you determined from the recon that an entire pitch or more of aid is necessary for the climb, you must augment the standard rack as necessary from the MAC Kit. In direct aid, you must find a placement every arms length, unlike free climbing where you have 8 to 10 feet or more to look for a good placement. This presents two problems, a massive amount of equipment necessary and getting used to moving upward on marginal placements.
  - a. **Amount of Equipment.** The amount of pro necessary to complete a 50 meter pitch may be as much as 40 placements, and out of the 40, many may be of the same size. For this reason you must tailor your rack to the climb. Recon the route, focusing on the crack width, then draw the appropriate amount of chocks and cams suitable for the crack. You must consider the possibility of having to leave two carabiners per piece of pro, so now you are looking at 80 free carabiners. This does not include the carabiners used to clip your pro to the rack. To save some equipment you can bypass putting a runner on every piece of protection. Clip in two linked carabiners to the pro, the second carabiner acts as a runner where you clip the rope.
  - b. **Slings.** Due to the weight involved with this much equipment it may be necessary to draw two padded racks. Sling them over both right and left shoulders and clip equipment to both racks and the climbing harness.

**TRANSITION:** Now that we have discussed the gear required, are there any questions? Let's talk about the techniques used in military aid climbing.

5. (10 Min) **TECHNIQUES USED IN MILITARY AID CLIMBING.**
  - a. Some of the simplest forms of aid climbing are known as "Hang Dogging" or "French Free" in the civilian climbing community. Hang Dogging involves clipping into a piece of protection, having the belayer take in all the slack and locking the belay device off so the climber can rest.

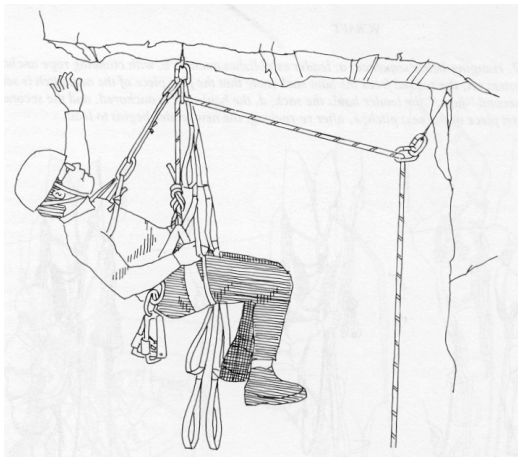

**HANG DOGGING**

b. French Free involves using protection to pull up or to stand up on. The most basic method is using aid for one move.

- (1) Set in a piece of pro and clip an etrier into it.
- (2) Step into the etrier and slowly transfer weight onto it in order to test the solidity of the piece of pro.
- (3) If it holds, conduct a bounce test with one foot in the etrier.
- (4) Step up higher in the etrier and bypass the difficult move.
- (5) If the problem is lack of a handhold, a short web runner can be clipped into the pro and used as a handle.



**FRENCH FREE**

c. Aiding through multiple moves is more difficult and time consuming.

- (1) The first aid movement is to place pro as high as possible and clip in two linked carabiners.

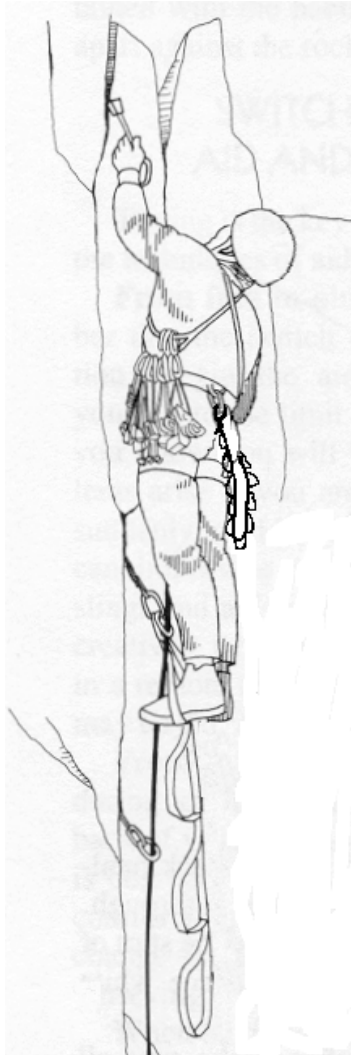

**AID CLIMBER USING ETRIER AND PLACING PRO**

- (2) Next, clip the daisy chain into the upper most carabiner of the pro just placed. All slack needs to be adjusted out of the daisy chain. Moving the carabiner down the daisy chain to the next clip in point does this, then slowly apply body weight to it. At this point you are hanging from the daisy chain, if you can reach up to the pro, your adjustment is correct.

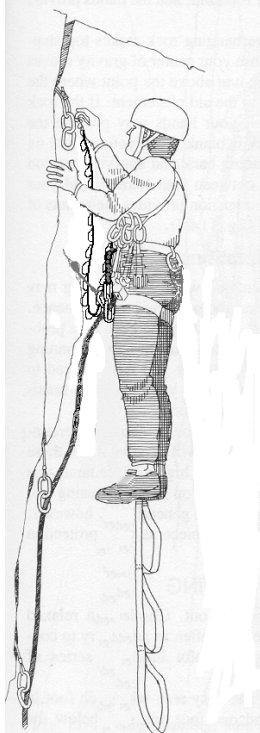

**CLIPPING DAISY CHAIN TO PROTECTION**

- (3) Now conduct a hanging bounce test. This is to ensure that the piece is solid prior to committing to it.



**HANGING BOUNCE TEST**

- (4) If the piece is solid, clip the etrier to it, upper most carabiner, and ascend the etrier.
- (5) Once your waist is level with the piece of pro, clip in the fifi hook to the upper most carabiner, sit back and rest. By clipping everything into the uppermost carabiner, the lower carabiner is free for the rope.
- (6) Now, clip the rope, into the lower, or free carabiner on the pro that you are hanging from. Note, if you clip the rope into the pro at an arms length, like when free climbing, you then ascend the etrier and the piece blows, you just increased the length of your fall.

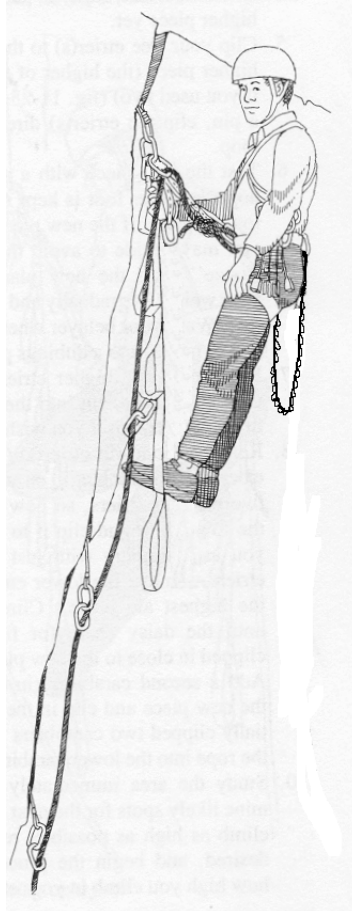

**RESTING ON A FIFI HOOK**

- (7) The sequence begins again; however, now that you are off the ground and hanging from the fifi hook, you place the pro, two carabiners, daisy chain and test. If the new piece blows, you should only fall a couple inches until your fifi hook on the previous piece stops you. For this reason, only unclip your fifi hook after the bounce test and just before ascending the etrier.

**NOTE:** Increased stability on a climb can be provided by using two etriers with a Daisy Chain attached to each however this requires drawing the extra equipment in advance.

- d. Due to the extreme amount of time involved in direct aid, the leader, once at the belay, should fix the rope to the anchor. The #2 climber should ascend the rope by use of mechanical ascenders, cleaning the pro while on a rope ascender. If the climbers do not have a set of rope ascenders, then it will be necessary for the #2 climber to aid the pitch and clean as he goes while being top roped. The only difference being, once the fifi hook has been released from the last piece of pro, the climber will hang from the daisy chain, or clip in the fifi hook to one of the steps of the etrier, hang and remove the previous piece of pro.

TRANSITION: Knowing the proper sequence and performing it correctly is critical. Are there any questions over techniques or the sequence?

**PRACTICE** (CONC)

- a. Students will practice what was taught in upcoming field exercises.

**PROVIDE HELP** (CONC)

- a. Instructors will provide help as necessary.

**OPPORTUNITY FOR QUESTIONS** (3 Min)

**1. QUESTIONS FROM THE CLASS**

**2. QUESTIONS TO THE CLASS**

Q. What is aid climbing?

A. Using equipment to directly ascend a rock face.

Q. What are three specialized pieces of gear used in aid climbing?

A. An etrier, daisy chain, and fifi hook.

**SUMMARY** (2 Min)

- a. During this period of instruction we have covered what military aid climbing is, the specialized gear required and how to conduct aid climbing. Remember that military aid climbing utilizes the equipment a leader already possesses as part of his climbing rack.
- b. Those of you with IRF's please fill them out and turn them in. We will now take a short break.

UNITED STATES MARINE CORPS  
Mountain Warfare Training Center  
Bridgeport, California 93517-5001

SML  
ACC  
02/19/02

LESSON PLAN

ALTERNATIVE BELAYS AND ANCHORS

INTRODUCTION

(5 Min)

- 1. GAIN ATTENTION.** At some stages during a climb there might be a need to construct belays or anchors that are unique to a certain situation. In some cases it may not be possible to construct a three point artificial or a two point natural anchor due to time constraints or lack of good protection available. Alternative belays and anchors can take on many guises. Be it rock spikes, flakes, boulders, trees, chocks wedged in cracks, and pitons. Most alternative belays and anchors are direct and dynamic.
- 2. OVERVIEW.** The purpose of this period of instruction is to provide the students who, after passing the climbing phase, have further knowledge and skills in the use of alternative belays and anchors. This lesson relates to *PARTY CLIMBING*.
- 3. METHOD/MEDIA.** The material in this lesson will be presented by lecture and demonstration.
- 4. EVALUATION.** This period of instruction is a lesson purpose class.

TRANSITION: Are there any questions over the purpose or how the class will be taught? As mentioned earlier, certain situations will dictate that you may have to use some sort of alternative belay or anchor. We will first discuss the belays.

BODY

(35 Min)

- 1. (15 Min) BELAY.** Belay is a method to stop a fall by applying friction to the rope and by resisting the forward pull of the fall. Besides the use of traditional devices in belaying operations, other techniques can be utilized. The following are a few expedient methods of belaying:

- a. Body Belay Method.** The body belay is used as a convenient and quick belay when



ascending and descending moderate terrain with experienced troops. Since friction burns are a real danger, the arms must be covered and gloves should be worn. This method can be used in both the standing or sitting stance. The following techniques apply for the body belay:

- (1) The belayer should position himself so that his legs are braced straight into the direction of pull.
- (2) Place the rope around the belayer's back so that the rope rests on top of the hips while he grasps the rope tightly with both hands.
- (3) To pay out rope, slide the running end of the rope (nearest the climber) forward with a guide hand and clasps both strands of the rope above the brake hand.
- (4) Allow the brake hand to slide back down to its original position and repeat the process.
- (5) To brake the climber, the brake hand wraps the rope around the waist. A twist of rope can be taken around the brake arm to increase friction.

- b.** Redirect Belay Method. When belays are established away from the base of a climb, the rope runs at a low angle from the belayer to the first piece of pro on the rock. From here the rope changes direction and goes abruptly upward. If the leader should fall, the rope goes taut and tries to run in a straight line from the belayer to the top piece of pro. This effect puts great strain on the bottom piece of pro. If it pulls out, the line of pro could be yanked out one after another from the bottom up. This is known as the "Zipper Effect". The zipper effect can be prevented by moving the belay stance within 10 feet of the base of the climb or by creating opposition protection.

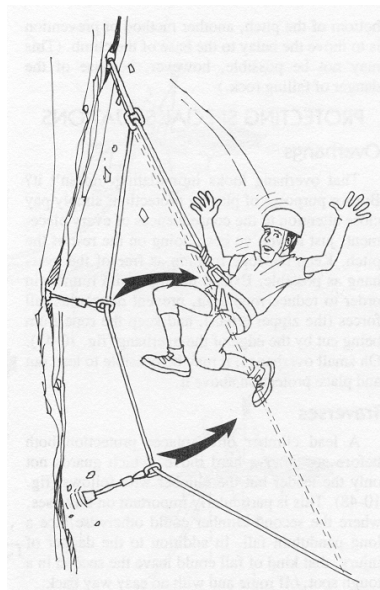

**ZIPPER EFFECT**

- (1)** Place one chock in the crack so it can take a downward pull.
- (2)** Below that emplacement, place another chock with an upward pull.
- (3)** Clip a carabiner into each chock wire / cord.
- (4)** Using a large runner, tie the two carabiners together using clove hitches so that there is tension between the two chocks, which will help hold them in place.
- (5)** Create a loop in the slack of the runner near the upward direction of pull chock by tying an overhand knot and attach a carabiner into the loop.
- (6)** Clip the climbing rope into this carabiner in the normal fashion.

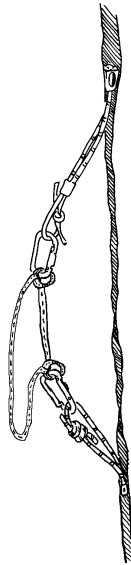

### **OPPOSITION PROTECTION WITHOUT THE OVERHAND KNOT**

- 1)** Place one chock in the crack so it can take a downward pull.
- 2)** Below that emplacement, place another chock with an upward pull.
- 3)** Clip a carabiner into each chock wire / cord.
- 4)** Clip one end of a large runner into the bottom piece of protection.
- 5)** Run the other end up to the second piece of protection and tie a clove hitch through the carabiner ensuring there is tension between the pieces to prevent the pulling out of either piece.

- 6) The running end of the runner may now be attached to the rope with a carabiner as a normal piece of protection.

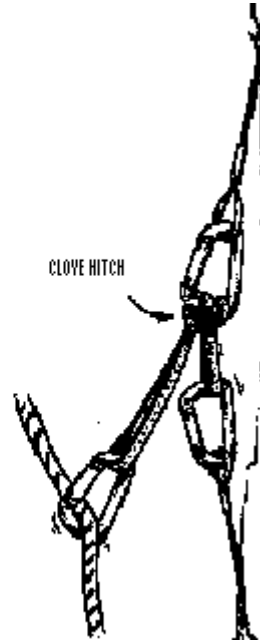

### ALTERNATIVE REDIRECT

- c. Expedient Belay Devices. Interlinked carabiners, figure eight descenders and even pitons can be used as expedient belay devices.

1) Carabiner Brake Method. Also known as the “Crab” brake. This method is somewhat complex to set up, but it has the advantage of not requiring any special equipment.

- a) Attach one locking or two non-locking opposite and opposed carabiners to the hard point on a harness.

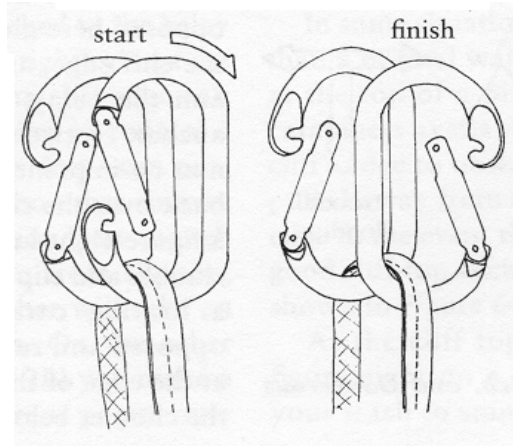

### OPPOSITE AND OPPOSED CARBINERS

- (b) Clip another pair of non-locking carabiners to the other carabiners already attached to the hard point.
- (c) Take a bight of the rope through the outer pair of carabiners.
- (d) Take another carabiner and clip it across the outer pair of carabiners beneath the bight of the rope.
- (e) The rope then runs across the outer edge of this final carabiner known as the brake crab.

### CRAB BRAKE

- (f) To brake, pull the rope forward causing a bight around the rope and the carabiner.

**(2) Figure Eight Method.** There are three ways to use the figure eight as a belay device.

- (a) Use the figure eight in the normal manner as in rappelling.
- (b) Pull a bight of the rope through the small hole of the figure eight and clip a carabiner through the bight. Belay in the same manner as with an ATC or stitch plate.
- (c) Place the figure eight on a carabiner in the normal fashion. Pull a bight through the large hole of the figure eight and clip it through the carabiner.

NORMAL FIGURE EIGHT

USING THE SMALL HOLE

USING THE CARABINER

**(3)** Petzl Grigri. The grigri is a specialized belay device that doesn't require any stopping force at all from the belayers hand. It works on the same principal as the safety belts in your car. With slow steady movements the rope feeds through freely. When there is a shock load (as in a fall) the grigri locks, jamming the rope with a cam. There is some tendency for the grigri to lock up when the leader makes a sudden move up. It also works badly or not at all with wet or icy ropes; that together with its weight and bulk, makes it largely unsuitable for mountaineering but quite useful in climbing gyms and in rock-climbing areas.

(a) Open the grigri and run the rope around the cam. Pay attention to the routing and ensure the load (leader) is on the end of the cam closest to the carabiner hole.

(b) Close the grigri and hook the carabiner from your harness (MAC) through the hole in the bottom of the grigri.

(c) Check the diagram and ensure the rope is run the correct way.

(d) Perform a function check by feeding the rope through the grigri with both hands. Then take the load rope (rope from the climbers harness) and give it a jerk. The grigri should lock and stop all movement.

(e) The left hand is the guide and the right controls the slack. Should a climber take a fall and you need to release the load or lower the climber, the left hand operates the load release lever. Note that you must maintain control of the slack rope with the right hand to help control the speed of the descent.

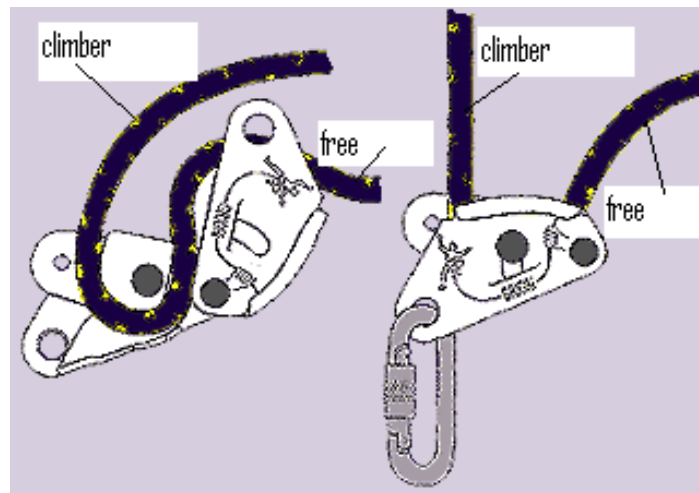

### **LOADING THE PETZL GRIGRI**

**(4)** Piton Carabiner Method. Not all pitons can be used for this technique due to some pitons being designed with sharp edges. Shallow angle pitons

work the best.

- (a) Place a locking carabiner into the hard point on a harness.
- (b) Clip another carabiner with a piton attached through its eyelet to the other carabiner already attached to the hard point.
- (c) Take a bight of the rope through the outer carabiner.
- (d) Place the piton beneath the bight so its pointed end rests on the opposite side of the carabiner it is attached to.
- (e) The rope then runs across the top of the piton.
- (f) To brake, pull the rope forward causing a bight around the rope and the piton.

TRANSITION: Now that we discussed alternative belays, let us talk about alternative anchors.

**2.** (10 Min) **ANCHORS.** Anchors are the ultimate security for any belay, the anchor should be able to hold the longest possible fall. There are many different types of anchors for different situations. The following are a few different methods of establishing an anchor system:

- a. The Cordelette Method. This method is good because sometimes the extra 10 or 15 feet of rope may be required to get to a better belay stance. It requires a 16-foot Type II cordage that is constructed into an endless loop.

**1**) Place three pieces of protection with carabiners attached.

**2**) Clip the Type II cordage into all three pieces of protection ensuring that the joining knot is located near one of the carabiners so that it will not be involved in the system.

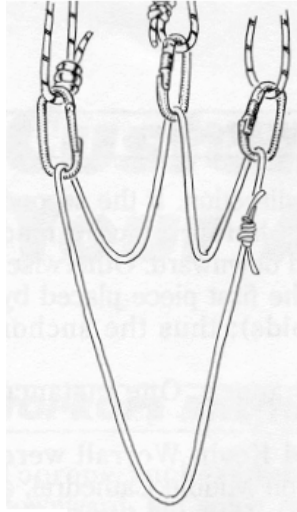

**3**) A bight will be pulled down between each of the pieces of pro so that there are three equal bights pointing in the anticipated direction of pull.

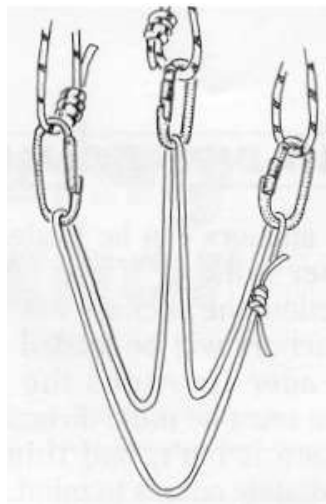

**4**) Tie an overhand knot at the end of the bights creating three separate equalized loops.

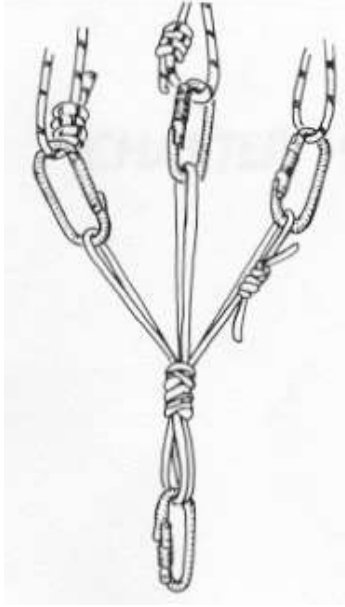

**5**) Clip a carabiner these loops. This carabiner will now serve as the main anchor point carabiner to the constructed system.

**b.** Multi-Point Equalizing Anchor. This method is good because it self equalizes if any pieces of pro happen to fail. It requires a long sling runner, which is clipped into three pieces of protection as with the cordelette method except:

- (1)** An additional carabiner that will serve as the main anchor point carabiner is clipped on the bottom of the hanging runner.
- (2)** The runner is grasped between each anchor, twisted 180 degrees, and clipping each resulting loop into the main anchor point carabiner. Such twists guarantee that the main carabiner is clipped into, and not around the runner, so that it will stay attached to the runner even if two of the three points fail.
- (3)** The smaller the runner the smaller the drop if one anchor fails. Therefore, if the anchors are wildly separated bring them together with other slings before equalizing.



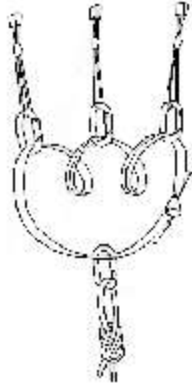

### **MULTI-POINT EQUALIZING ANCHOR**

- c.** Special Considerations for Belay Stance Anchors. To safe guard the #2 from possible hazards i.e. belaying from a ledge, waves from the sea during amphibious assaults, etc., two pieces of protection will be placed in the direction of pull while the third will be place in the opposite direction of pull.

- 1** ) Place the three pieces of artificial protection keeping in mind the anticipated direction of pull if the lead climber fell.
- 2** ) Ideally the # 2 would place two of the pieces behind him with the direction of pull up. These two anchors should be the first pieces clipped when constructing the anchor.
- 3** ) The third piece will be placed in front of the belay stance with the direction of pull down. This piece of protection will prevent the belayer from being pulled off his stance unintentionally.
- 4** ) The belay stance will be constructed in the manner as taught in *BELAYING FOR PARTY CLIMBING*.

TRANSITION: During this period of instruction we have talked about various alternatives to belaying and anchoring. Remember safety is paramount and only use alternative methods if all other methods have been exhausted.

### **PRACTICE**

(CONC)

- a.** Students will practice establishing Alternative belays.

### **PROVIDE HELP**

(CONC)

- a. Instructors will assist the students when necessary.

### **OPPORTUNITY FOR QUESTIONS**

(3 Min)

**1. QUESTIONS FROM THE CLASS**

**2. QUESTIONS TO THE CLASS**

**Q.** What are three alternative methods to belay?

- A.** (1) Body Belay  
(2) Redirect Belay  
(3) Expedient Belay Devices

**SUMMARY**

(2 Min)

- a.** During this period of instruction we have discussed the various alternative methods of belays and anchors.
- b.** Those of you with IRF's please fill them out and turn them in to the instructor. We will now take a short break.

UNITED STATES MARINE CORPS  
Mountain Warfare Training Center  
Bridgeport, California 93517-5001

SML  
ACC  
02/19/02

**LESSON PLAN**

**RESCUE TECHNIQUES FOR PARTY CLIMBING**

**INTRODUCTION**

(5 Min)

- 1. GAIN ATTENTION.** Climbing and mountaineering by its nature is an occupation which involves a certain amount of risk, many of these risks can be eliminated or reduced by sound training, common sense, and by wearing and using the right equipment for the task at hand. However, accidents may occur even though you have taken all prudent precautions to protect yourself and your partner. You may very well find yourself having to rescue your partner or even have to be rescued yourself. It is therefore important that you should have a sound working knowledge of the basic self help and rescue techniques used.
- 2. OVERVIEW.** The purpose of this period of instruction is to familiarize the student with the methods in which to rescue himself or his climbing partner in the event one sustains an injury serious enough that they can no longer continue to climb. This lesson relates to *PARTY CLIMBING*.
- 3. METHOD/MEDIA.** The material in this lesson will be presented by lecture and demonstration. You will practice what you have learned immediately following this period of instruction.
- 4. EVALUATION.** This period of instruction is a lesson purpose class.

**TRANSITION:** Are there any questions over the purpose or how the class will be taught? First we will talk about what we will need to know to determine a rescue.

**BODY**

(55 Min)

- 1. (5 Min) ASSESSING THE SITUATION.** A party climb rescue can become time consuming, and precious minutes are involved when dealing with injuries. Whenever an injury occurs while climbing, whether it involved the #1 or #2 climber, you should first assess the situation and determine the following:
  - a.** Is the climber conscious or unconscious?

- b. How severe is the injury involved?
- c. What's the location of the injured climber? (i.e. less than half the distance of the rope or more than half the distance of the rope)
- d. Do you have enough gear to conduct the rescue?
- e. Can the other climbing teams in the area assist you in the rescue?
- f. How familiar are the climbers with the rescue techniques?

**NOTE:** The answers to the above questions will determine which method should be used to rescue the climber.

**TRANSITION:** Now that we have discussed the factors involved when to conduct a rescue, are there any questions? Now we will discuss how to do it.

**2.** (5 Min) **ESCAPING FROM THE SYSTEM.** This is a phrase used to describe the technique of releasing one's self from the belay, while ensuring that the climber you are responsible for is safe and secure. The reasons for escaping are varied and too numerous to mention; however, once you have established the reason to escape, you should work logically, safely, and try to keep it as simple as possible. The procedures are as follows:

- a. Lock the climber off.
- b. Once the belay device is locked off pass a bight through the belay device carabiner.
- c. Tie the belay device off around the load rope with two-half hitches.
- d. Untie your retraced figure of eight knot and pull the end of the rope out through your harness.

**TRANSITION:** Now that we discussed how to escape the system, are there any questions? Now let's talk about rescuing an injured lead climber.

**3.** (20 Min) **RESCUE AN INJURED LEAD CLIMBER.** When conducting two party climbing, there is a greater chance that the lead climber will suffer injuries from a fall vice the #2 climber who is being top roped. After assessing the situation, a plan must be devised as soon as possible. The following are different methods which could be utilized:

- a. Lowering the Injured Climber. The method of lowering will depend upon two factors; how much rope was used and if the injured climber is conscious or not.

**1.)** Less than Half the Rope Distance. If less than half the rope has been used during the climb, it may be feasible to just lower the victim. Normally, the cause of the injury was due to a fall, which seated the protection firmly. If the injured climber is

conscious, he will back the lowering protection point up with another piece of protection and equalize it.

**2 )** More than Half the Rope Distance. If more than half the rope has been used during the climb and the injured climber is conscious, he will conduct the same actions as above and the following:

**a)** Clean the route on his way down.

**b )** Descended past the half way mark and locate a feasible stance to tie himself off to the rock using an equalized anchor system.

**c)** Pull some slack up from the bottom and tie it off to a hard point.

**d )** Untie the retrace figure eight from his harness and pull the rope through the lowering point.

**e)** Once the rope has cleared the lowering point, he will attach the end of the rope back into his harness with a retrace figure eight.

**f )** Untie the slack rope from the hard point and have the belayer take in all the slack.

**g)** Taking a bite from his retrace figure eight, he will clip it into the equalized anchor system.

**h )** Ensuring that the belayer has taken in all the slack and that the brake is applied, he will detach himself from the equalized anchor system.

**i )** The belayer will then lower the victim.

**b.** Assistance from other Climbing Teams. Other climbing teams in the area can provide assistance if needed. There are two options for their assistance, which depends upon their location, either on the top or the bottom.

**1 )** A climbing team on the top can set up a rappel lane and conduct a tandem rappel as taught in *MOUNTAIN CASUALTY EVACUATION*.

**2 )** A climbing team on the bottom can perform the rescue by performing the following actions:

**a)** Conduct a two party climb up to the victim and establish a hanging belay as described in *BELAYING FOR PARTY CLIMBING*.

**b )** The leader will pull up all of the rope and tie a figure eight loop in the end of the rope. This loop will be clipped into the victim's donut with a locking carabiner.

- c) The leader will establish a belay to the victim and tie the belay off.
- d) The victim's retrace figure eight can be untied or cut if necessary.
- e) The leader can now untie the belay and lower the victim to the ground.

**NOTE:** A climbing rope will not be cut unless it is a true emergency and extreme precaution must be taken so that only the victim's rope is cut.

**TRANSITION:** Are there any questions over rescuing an injured lead climber. In some circumstances you may have to rescue the No. 2. Normally he will be either injured from falling rock or unconscious.

**4. (20 Min) RESCUE AN INJURED NO 2.** There are several ways to assist an injured No. 2 climber we will cover just a few.

- a. **Assisted Hoist.** The assisted hoist is most frequently used in situations where your second is unable to climb a particular part of a climb or he may have fallen off to one side and is unable to get back onto that climb. It is not necessary for the rescuer to escape from the system to set up the hoist, however in some circumstances it may well be easier to set up and work if you get yourself out of the system, but remember to secure yourself once you are out.

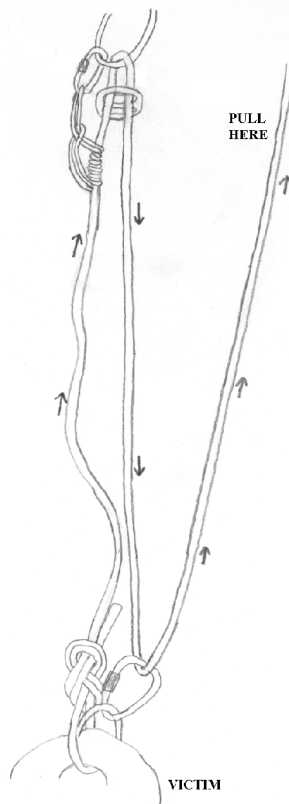

**ASSISTED HOIST**

**NOTE:** This system can only be set up and used if you are within 1/3 of the ropes length of each other.

- 1 ) Tie off the belay device. Attach an Autoblock knot on the load rope, then secure it back to the MAC, and slide it down until all the slack is taken out.

**NOTE:** Make sure that the Autoblock is not too long, no more than 1 foot from the belay device, otherwise, it will slide out of arms reach when loaded.

- 2 ) Take a bight in the loose end of the rope and clip a carabiner into it.
- 3 ) Lower the bight and carabiner down to victim and tell the victim to clip it into the strong point of their harness, making sure that the rope is not twisted.
- 4 ) Untie belay device and gently lower victim's weight onto the autoblock. The victim will pull the center downward moving rope.
- 5 ) Both rescuer and victim pull at the same time, the victim walks up the rock face to assist the hoist. Should either require a rest, you simply lower the victim's weight onto the autoblock.

- b. Unassisted Hoist. There may be circumstances on a multi pitch climb when you might need to hoist an injured or unconscious victim rather than try to lower them down to a safe stance. If you should be unfortunate enough to be in this type of situation, then a mechanical advantage will save a lot of energy and backache.

- 1 ) Three-to-one-Hoist. One of the simplest of the mechanical advantages to set up, but remember to work logically and safely.

- a) First tie off your belay device and escape from the system and anchor yourself.
- b) Attach an autoblock to the loaded rope and secure it back to the MAC, slide it down until slack is taken up.
- c) Untie belay device and gently release the loaded rope onto autoblock.
- d) The loaded rope is then secured by retying the belay device.
- e) Take a short prusik loop and put a French prusik onto the loaded rope as far down as you can reach, clip in a carabiner.

**f**) Untie the belay device and take the slack rope from the carabiner at the anchor point and run it down and back through the French prusik carabiner previously placed on the loaded rope.

**g**) The victim's weight is now hanging on the autoblock that was put on after you escaped from the system. It may be necessary to shorten the autoblock closer to the anchor point for greater effectiveness; this can be done when the weight has been taken off the autoblock during hoisting.

**h**) To hoist the victim, pull on the slack end of the rope. If the victim is conscious, he can help by walking.

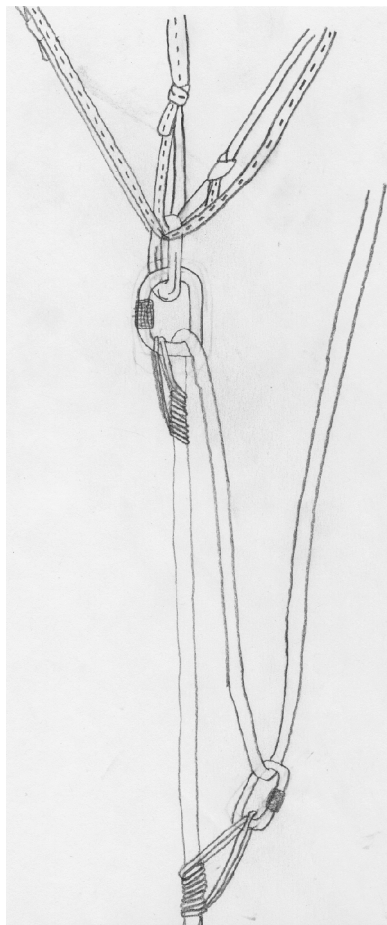

### **THREE TO ONE HOIST**

**i**) As you pull, the French prusik will come up to meet the autoblock, at this point lower the victim's weight onto the autoblock and then slide the French prusik back down the loaded rope as far as possible. This procedure is repeated until the victim is where you require him. If there is enough space you can attach



the pulling rope to your harness through your belay device, and use your body weight instead of your arms.

**NOTE:** This system can be easily upgraded to a 9:1 to enhance leverage. If available, pulleys can be used to prevent unnecessary friction.

**TRANSITION:** Are there any questions over the rescue of the #2? Saving the victim's life is important, but remember to be safe so that you do not become a victim as well.

**PRACTICE** (CONC)

- a. Students will practice rescuing both the injured No 1 and No 2.

**PROVIDE HELP** (CONC)

- a. The instructors will assist the students when necessary.

**OPPORTUNITY FOR QUESTIONS** (3 Min)

**1. QUESTIONS FROM THE CLASS**

**2. QUESTIONS TO THE CLASS**

- Q. When using the assisted hoist what is the furthest distance that you can be away from the victim?

- A. 1/3 the distance of the rope.

- Q. What situations would determine the need to conduct a party climb rescue?

- A. (1) Is the climber conscious or unconscious?
- 2 ) How severe is the injury involved?
- 3 ) Do you have enough gear to conduct the rescue?
- 4 ) What's the location of the injured climber? (i.e. less than half the distance of the rope or more than half the distance of the rope)
- 5 ) Can the other climbing teams in the area assist you in the rescue?
- 6 ) How familiar are the climbers with the rescue techniques?

## **SUMMARY**

(2 Min)

- a. During this period of instruction we have discussed and demonstrated those skills necessary to escape from a belay and rescue a fallen climber, including hoists and improved hoists.
- b. Those of you with IRF's please fill them out and turn them in to the instructor. We will now take a short break.

UNITED STATES MARINE CORPS  
Mountain Warfare Training Center  
Bridgeport, California 93517-5001

SML  
SMO  
ACC  
02/19/02

**LESSON PLAN**

**STEEP EARTH CLIMBING**

**INTRODUCTION**

(5 Min)

- 1. GAIN ATTENTION.** As a mountain leader you must know how to negotiate all types of terrain in the mountains. Steep earth climbing may be done by a trained mountaineering team when climbing steep earth slopes is required.
- 2. OVERVIEW.** The purpose of this period of instruction is to introduce the student to steep earth climbing, including the equipment used, procedures used, and organization.
- 3. METHOD/IMEDIA.** The material in this lesson will be presented by lecture and demonstration. You will practice what you have learned in upcoming field exercises. Those of you with IRF's please fill them out at the conclusion of this period of instruction.
- 4. EVALUATION.** This is a lesson purpose class, you will not be formally evaluated on this period of instruction.

**TRANSITION:** Are there any questions over the purpose or how the class will be taught. This brings us to the first part of our class, the equipment needed.

**BODY**

(40 Min)

**1. (5 Min) EQUIPMENT NEEDED.**

- a.** Each climber will need the following equipment.

**1** ) Climbing harness\_

**2** ) Mountain boots with a half or full shank if possible.

**3** ) Helmet

4 ) Gloves

5 ) One 165 foot climbing rope per team

6 ) One earth axe (short ice axe)

7 ) One alpine hammer, Northwall style ice hammer, or a heavy wall type hammer

8 ) Five finger/point gripfast

9 ) Twelve point crampons.

10 ) Sling rope

11 ) Snow stake

12 ) Rebar (1,2, and 3 foot lengths)

- b. The #2 climber will have a five point hand grapnel with at least 20 feet of knotted 7mm cord and a 165 foot knotted climbing rope.
- c. Earth Ax Construction. The earth ax is a short ice ax which can be used to cut steps or hand holds. The pick can be used to gain holds in earth or rock. This should be “dummy – corded” to the climber.

TRANSITION: Are there any questions over the equipment needed? The next thing we will discuss is the climbing procedures.

## 2. (10 Min) CLIMBING PROCEDURES

- a. Route Reconnaissance. The route is visually inspected for steepness, soil composition, rock outcroppings, ice and snow patches, and availability of anchor’s. Based on this reconnaissance, the climbers construct a climbing rack best suited to the proposed climbing route.
- b. Normal belay procedures are used. The belayer establishes the bottom of the climb using available anchors supplemented by a 5 point gripfast. He will tie into the end of the rope and into the gripfast.
- c. Once the belay is established, the lead climber ties in and begins his climb. The climber will cut steps with the adze of his earth ax for foot holds. As soon as possible after beginning the climb, the lead attempts to place an intermediate anchor. Depending on the composition of the face being climbed, this anchor may be an ice or rock piton, a chock, camming device, or a specialized steep earth anchor. The climber must remember that any protection placed in steep earth has questionable holding strength. The climber uses his ax for a hand hold and uses his free hand for balance or uses an alpine hammer or ice

hammer for his second hand tool.

- d. The lead climber digs a belay platform at the end of his rope if required. He then plants his gripfast, ties into it, and sits on it for additional security. If possible, he establishes an anchor using pitons, chocks, camming devices, etc. The lead climber then belays up the #2 climber.
- e. The #2 climber climbs towards the belay stance, collecting all unused protection as discussed in *PARTY CLIMBING*.
- f. This procedure continues until one climber reaches the top, establishes a belay stance with an appropriate anchor, and top ropes his companion up.

TRANSITION: Now that we covered climbing procedures, are there any questions? Let's now talk about the use of the grapnel.

**3. (5 Min) USE OF THE GRAPNEL**

- a. A five point grapnel can be useful in steep earth climbing. With its twenty feet of knotted cord, it provides handholds where there may otherwise be none. Short, sheer faces and overhangs have fewer holds, thus providing ideal situations for grapnel use.
- b. To use the grapnel, the climber unwinds his grapnel line, secures it to himself, then throws it above himself over a ledge, cliff edge, or other near horizontal feature. Care must be taken to throw it to one side or the other so that if it doesn't hold it won't fall on the climber or his belayer. After the grapnel has landed, the climber pulls it slowly until it is securely caught.
- c. The climber now climbs up the difficult section, assisted by the grapnel line, keeping the pull steadily down. Changing to a palms down grip at the top will help to keep the grapnel in place.
- d. Once at the top, the climber checks the security of the grapnel and changes its position if necessary. He then establishes a belay and belays the second climber up. The second climber uses the grapnel line as necessary.

TRANSITION: Are there any questions over the use of the grapnel? Let's now discuss what the troops on the top and bottom will do.

**4. (5 Min) DUTIES OF PERSONNEL ON THE BOTTOM**

- a. 180 degrees security is set up.
- b. Troops at the bottom should not be directly under the climbing site because of the loose rock and dirt that could fall upon them causing an injury.

**5. (5 Min) DUTIES ONCE ON TOP**

**a.** Security

**1** ) The first man up makes a hasty recon of the area before belaying up the other climber.

**2** ) Once the lead climber has conducted a hasty recon, he starts setting up the knotted hand line at a suitable climbing site for a fixed rope while the #2 climber provides security.

**b.** The site selected should be as follows:

**1** ) Good natural anchors, these may have to be multiple small shrubs or bush type anchors.

**2** ) Artificial anchors, i.e. gripfast, pickets, deadmen, and chocks.

**3** ) Make sure the rope reaches the bottom.

**4** ) Minimum of loose rocks and dirt.

**c.** Knotted hand line should be pre-knotted to save time and brought up by the #2 climber.

**d.** 180 degree security is set up as Marines reach the top.

**e.** Assault leader and automatic weapons teams will go up first.

**f.** The assistant leader and automatic weapon team will be the last to come up as the 180 degree security on the bottom gets smaller.

**g.** The ropes are pulled up and coiled once everyone is on top.

**h.** All evidence such as anchors, indentations or rope marks on the edge of the dirt are removed.

**i.** Area is policed of any other evidence.

TRANSITION: Now that we have covered the duties of the Marines on the top and bottom, are there any questions? Steep earth is a vertical obstacle. To effectively move troops over the obstacle, the same principles can be used on a cliff assault. If there are no questions for me, then I have some for you.

**PRACTICE** (CONC)

**a.** The students will climb steep earth.

**PROVIDE HELP** (CONC)

- a. The instructors will assist the students when necessary.

### **OPPORTUNITY FOR QUESTIONS**

(3 Min)

#### **1. QUESTIONS FROM THE CLASS**

#### **2. QUESTIONS TO THE CLASS**

Q. What equipment is carried by the lead climber?

A. Helmet, boots, climbing harness, crampons, gloves, one earth ax, one alpine hammer/ice hammer, gripfast, 165 foot climbing rope, climbing rack, and plastic lens glasses/goggles.

Q. What equipment is carried by the #2 climber?

A. Same as the lead climber except the #2 climber carries the grapnel.

### **SUMMARY**

(2 Min)

a. During this period of instruction we have covered how to climb steep earth terrain, the equipment needed, the roles of each team member, and the duties at the bottom and the top of the cliff face.

b. Those of you with IRF's please fill them out at this time and turn them in to the instructor. We will now take a short break.

UNITED STATES MARINE CORPS  
Mountain Warfare Training Center  
Bridgeport, California 93517-5001

SML  
SMO  
02/19/02

**LESSON PLAN**

**TREE CLIMBING TECHNIQUES**

**INTRODUCTION**

(5 Min)

1. **GAIN ATTENTION.** During many of today's conflicts the use of aircraft is becoming increasingly important. Oftentimes pilots and their aircraft are on the leading edge of the American sword. As such they're occasionally disabled and find themselves having to bail out in a hostile or non-permissive environment. When this happens American forces will be mobilized and launch what we call a TRAP recovery force. Tactical recovery of aircraft and/or pilots is a specialized mission that may require the skills of an assault climber.
2. **OVERVIEW.** The purpose of this period of instruction is to introduce the student to the skills needed to accomplish a rescue of a pilot from a tree.
3. **METHOD/MEDIA.** The material in this lesson will be presented by lecture and demonstration. You will practice what you have learned immediately after this period of instruction. Those of you with IRF's please fill them out at the conclusion of this period of instruction.
4. **INTRODUCE LEARNING OBJECTIVES.**
  - a. **TERMINAL LEARNING OBJECTIVES.** In a wooded environment and given the proper equipment, recover a pilot from a tree in accordance with the reference.
  - b. **ENABLING LEARNING OBJECTIVES.**
    - (1) Without the aid of references, list in writing the lead climbing methods for ascending a tree in accordance with the references.



- (2) Without the aid of references, describe in writing the technique used to lower a pilot from a tree in accordance with the references.

5. **EVALUATION.** You will be tested on this period of instruction by written and performance evaluation.

**TRANSITION:** Now that we know what to expect and what the class is about let's talk about a pilot TRAP.

**BODY**

(60 Min)

1. (5 Min) **TRAP.** The Tactical Recovery of Aircraft and Personnel (TRAP) is an ACE mission similar to Combat Search and Recovery (CSAR). The main difference is the recovery of aircraft and the possible use of ground forces. As such, the TRAP force is responsible for expeditiously providing recovery and repatriation of friendly aircrews and personnel, from a wide range of political environments and threat levels. Additionally, equipment will either be recovered or destroyed depending on the threat and the condition of the downed aircraft.
  - a. For an Assault Climber the TRAP mission may require a lead climber to climb a tree and retrieve an unconscious/disabled pilot. To accomplish the mission safely ropecraft will be necessary.

**TRANSITION:** Now that we have an understanding what is a pilot TRAP, let us now discuss the equipment needed for a rescue.

2. (10 Min) **EQUIPMENT.** The amount and variety of the equipment needed is situational and you must be flexible. As a general rule the following equipment is sufficient for most missions:
  - a. Harness or sling rope
  - b. Static rope/165-300 ft.
  - c. Ten aluminum non-locking carabiners
  - d. Six steel locking carabiners
  - e. Fifteen assorted runners (longer the better)
  - f. Optional:
    - (1) One pr. of jumars
    - (2) Two pulleys
    - (3) One set of gaffs and strap/crampons can work

(4) One line launcher

(5) Pitons w/ hammer

**TRANSITION:** Are there any questions concerning the equipment necessary to conduct a rescue? If not, let's talk about the different types of techniques to rescue the entangled personnel.

3. (20 Min) **ASCENDING TECHNIQUES.** Prior to executing a TRAP, a method of retrieval should be tentatively planned for. There are a number of techniques to be utilized and the situation and equipment available will determine which of these you will use.
  - a. **Lead Climbing:** Using this method a lead climber will ascend the tree using one of four techniques. All four techniques will require both the number one climber and the number two climber to tie into the end of the rope. The number two will establish an anchor and belay system as discussed in *BELAYING FOR PARTY CLIMBING*.
    - (1) By use of gaff and straps/crampons. This is the fastest and easiest means of ascending a tree. By using the strap, the climber negates having to place protection for themselves and the use of gaffs/crampons provide quick and easy footholds for ascending even the tallest of trees.

**NOTE:** Marines must be "pole climber" certified by the field wiremans course to use gaffs and strap.

- (2) By using the girth hitch method. This method is tiring and slow but is very safe. Start by girth hitching two runners around a tree. These runners should be long enough to create about a 3-4ft. loop for the foot. The top runner is attached to the climber's harness by use of steel locking carabiner. Grip the tree and stand up in the loop of the bottom girth hitch. Slide the top girth hitch up as high as possible and hang from it. Grab the bottom girth hitch and move it as high as possible, insert your foot and stand up again. This process will repeat itself until you have gained your desired height. If you encounter branches along the way you will have to bypass them. This is done by having a third runner in which you will attach above the tree limb. You will place a girth hitch with the third runner and attach it to your harness, slide the bottom runner up as far as possible and stand so that you can slide the top runner up and bypass the tree limb.
- (3) Using the Monkey method. This method is dependent on the size and type of tree being climbed. Smaller diameter trees with lots of branches are optimal. Essentially the lead climber will just free climb the tree using branches and shimmying up the trunk with appropriate protection for the climber being accomplished by placing runners around the tree in a quad hitch or girth hitch fashion.
- (4) Party Climb method. This method is similar to that of the monkey method with the exception that the lead climber will place pitons in the tree or girth hitch runners

around branches for protection. The climber will clip into these pieces of protection as taught in party climbing.

b. Jumar Climbing Techniques:

- (1) Jumaring: In order to Jumar or “rope walk” to the pilot it is necessary to first establish a rope above the pilot. The use of a line launcher or 550 cord around a canteen will aid in getting the rope up the tree. 550 cord will be the most likely tool utilized by Marines when using this technique. You must first attach the 550 cord to a half-full canteen or a heavy carabiner; then throw it up to the desired branch to loop it around. Once this is done you can tie your climbing rope onto the 550 cord and pull the other end of the 550 cord up and around the tree branch until you have both ends on the ground. There are four methods that you can use to jumar or rope walk up the rope to the pilot:
  - a. Body Thrusting. This method is very tiresome but requires little gear. First the climber will tie a tautline hitch with the end of the rope then ties a figure of eight above the tautline hitch and clips it into his harness with a locking carabiner. The climber will then pull down on the opposite rope that he is tied into, sliding the tautline hitch up along with him which will act as the friction device (a jumar here works really well and is easier to control). To work your way back down the climber will break the tautline hitch so he can slide it down and do everything in reverse to work his way down the tree.
  - b. Footlocking: This method is also tiresome and requires little gear. This is similar to hand over hand method (i.e., the O course ropes). The climber will attach a Prusik knot to the two ropes hanging down from the tree and attach that to his harness then hand over hand his way up using his feet to bend and lock the rope in place to aid him in ascending the rope. To get down the climber will do everything in reverse.
  - c. Jumar/Texas Kick: This method is the easiest but requires the most gear. The climber will attach one end of the rope to his harness using a figure eight with carabiner clipped into hard point. Next the climber will attach a foot jumar and a chest jumar or Texas Kick Prusik (as discussed in *Glacier Travel*) to the opposite rope to which the climber is tied into. The climber will then slide the top jumar (body Prusik) as high as possible then slide the foot jumar up and stand, unweighting the top jumar so that it can be moved up higher. This process will repeat itself until the climber has reached the desired height.
  - d. Haul system: This is the most desired method and requires very little gear but requires manpower. Once the rope is looped around the tree limb the climber will tie into one end of the rope, then a mule team will hoist the climber up to the desired height.

**NOTE:** All of these techniques require the rope to run in the crotch of a tree branch and the trunk of the tree, so rope wear should be considered because of the friction that is occurring when ascending.

TRANSITION: Now that we have reached the pilot and have him securely rigged, let us discuss the procedure for lowering him safely to the ground.

4. (10 Min) **LOWERING TECHNIQUE.**

- a. Once the leader has ascended the tree to the appropriate height, he must then anchor himself slightly above the pilot. This can be done by quad hitching or girth hitching a runner to the tree and hanging from it. The leader must then construct a secondary anchor to lower the pilot down on. This can be accomplished in the same manner as before with girth hitches. Once complete the climber will then do one of two things: if no second rope is available then he will untie from his rope (making sure that he is safely tied off first) and run it through the anchor for lowering the pilot. If a second rope is available it would be wise to stay tied in for safety and use a separate rope for the pilot.
- b. Once the rope is fed through the anchor for lowering, a figure eight will be tied into one end and a locking carabiner will be attached. If the pilot is conscious you can lower it to him and have him connect it to the D-rings located on the front of his harness. In the event the pilot is unconscious then you must lower yourself to him and attach it yourself. If the D-rings cannot be accessed then quad hitch a runner through the shoulder portion of the pilot's harness and attach to the rope with a locking carabiner. At this point you are ready to release the pilot from his parachute.
- c. Double check your system: Ensure all slack is out of the system and a belay is on. This is critical you must ensure that you and the pilot are safe before releasing his parachute. Once you've double-checked everything you need to reach down to the pilot and pull the cable loop type canopy releases located on the shoulder portion of the pilots harness. This will cause a slight shock load onto your rope once executed, so be ready. After the pilot is free slowly lower him to the ground via your belay man.

TRANSITION: Now that the pilot is safely on the ground, there are other considerations that we must take into account.

5. (5 Min) **OTHER CONSIDERATIONS.**

- a. Medical assistance: A corpsman should be present to assist in providing medical attention if needed. A backboard and cervical collar should be planned for and when lowering the pilot it is best to lower him directly onto the backboard or litter. If your climbers are well versed in high angle rescues then the pilot can be put into the litter while still in the tree if his injuries require (this is specialized and not a part of this course).
- b. DOD form 1833: This classified report has key information to be used in identifying a pilot. This report is called the isolated personnel report or isoprep data. The information provided is personal and specific. Often this data is verified prior to insertion. The TRAP recovery force needs them to authenticate upon location of the pilot. **NEVER** take a filled out DOD form 1833 or the data with you, memorize it.

TRANSITION: Now that I have discussed tree climbing techniques, are there any questions? If there are none, then I have some for you.

PRACTICE

(CONC)

- a. The student will retrieve a pilot from a tree in a safe manner using the techniques taught.

PROVIDE HELP

(CONC)

- a. The instructors will assist the students when necessary.

**OPPORTUNITY FOR QUESTIONS**

(3 Min)

1. QUESTIONS FROM THE CLASS

2. QUESTIONS TO THE CLASS

Q. What are the four different climbing techniques?

- A. (1) Gaffs/straps
- (2) Girth hitch
- (3) Monkey method
- (4) Party Climb

Q. What is the last thing you do prior to releasing the pilot from his parachute?

- A. Recheck your system.

**SUMMARY**

(2 Min)

- a. During this period of instruction we have discussed various techniques of ascending a tree and how to safely lower a pilot to the ground.
- b. Those of you with IRF's please fill them out at this time and turn them into the instructor. We will now take a short break.

**UNITED STATES MARINE CORPS**  
Mountain Warfare Training Center  
Bridgeport, California 93517-5001

SML  
ACC  
02/19/02

**LESSON PLAN**

**FIXED ROPE INSTALLATIONS**

**INTRODUCTION**

(5 Min)

- 1. GAIN ATTENTION.** In a mountainous battlefield, gaps or soft spots in an enemy defense are usually cliffs or steep slopes. These gaps can be easily exploited by the use of fixed rope installations. Fixed ropes also aid heavily laden troops in ascending steep to moderate slopes.
- 2. OVERVIEW.** The purpose of this period of instruction is to introduce the student to fixed rope installations. This will be accomplished by discussing the types of fixed ropes, installing, maintaining, ascending, and clearing the fixed ropes. Also, we will discuss special considerations for long pitches and cable ladders. This lesson relates to cliff assault.

**INSTRUCTOR NOTE:** Have students read learning objectives.

**3. INTRODUCE LEARNING OBJECTIVES**

- a. TERMINAL LEARNING OBJECTIVE.** In a summer mountainous environment, construct a fixed rope installation, in accordance with the references.
- b. ENABLING LEARNING OBJECTIVES.**
  - 1 )** Without the aid of references, define in writing each type of fixed rope installation, in accordance with the references.
  - 2 )** Without the aid of references, describe in writing the conditions for positioning the climbing rope in relationship to the climber along the route of a fixed rope installation, in accordance with the references.
  - 3 )** Without the aid of references, describe in writing the criteria for maintaining a fixed rope installation, in accordance with the references.

**4. METHOD/MEDIA.** The material in this lesson will be presented by lecture and demonstration method. You will practice what you have learned in upcoming field training exercises. Those of you with IRF's please fill them out at the conclusion of this period of instruction.

**5. EVALUATION**

- a. SML - You will be tested later in the course by written and performance evaluations.
- b. ACC - You will be tested by a written examination and by a performance evaluation on your company's cliff assault.

TRANSITION: Are there any questions on the learning objectives, what we will be covering, how this lesson will be taught, or how you will be evaluated? If not, let's begin by talking about sight selection.

**BODY**

(90 Min)

**1. (5 Min) ROUTE SELECTION.** Ropes and caving ladders assist heavily laden troops in ascending steep terrain. They should be used where a fall might result in injury. Choose a route that will allow a Marine to be ready to fight upon reaching the top. These two factors determine the maximum possible difficulty of the route:

- a. Climbing unit's experience and ability.
- b. Climbing unit's load.

TRANSITION: Now that we discussed the factors of determining route selection, are there any questions? Let's discuss cliff assault ropes.

**2. (5 Min) CLIFF ASSAULT ROPES.** There are three types of fixed rope installations that can assist Marines up steep terrain: simple fixed ropes, semi-fixed ropes and fixed ropes.

- a. Simple Fixed Ropes. The simple fixed rope is defined as being anchored at the top end of a rope. This type of rope installation is primarily designed to aid heavily laden Marines in the ascent or descent of a steep to moderately steep slope. The rope can be used for aid when climbing by pulling on the rope and walking the feet up the slope. A knotted hand line may be used for this purpose.

**1 )** Advantages:

- a) It is simple, fast, and easy to construct.
- b) It requires no extra gear or time to attach each climber to the rope.

**2 )** Disadvantages:

a) Cannot be used on near vertical to vertical terrain.

b) If a climber lets go of the rope, he may fall down the slope.

1 ) Advantages:

### SIMPLE FIXED ROPE INSTALLATION

b. Semi-Fixed Ropes. This type of rope installation is also designed to aid heavily laden Marines in the ascent or descent of a steep to moderately steep slope. Also known as a Fast Lane. This installation is anchored at the top and bottom but has no intermediate anchor points.

a) More climbers can be on the rope.

b ) Least chance of injury due to safety prusik.

2 ) Disadvantage:

a) The route runs in a direct line.

c. Fixed Ropes. The fixed rope is defined as being anchored or fixed at both ends as well as with intermediate anchor points. This type of rope installation is primarily designed to protect heavily laden troops while negotiating snow / icy slopes, difficult scrambles, traverses or other slopes where balance climbing may be hazardous.

1 ) Advantage:

a) It can be used in routes that change directions.

b ) Protects the climber from a lateral fall hazard.

2 ) Disadvantages:

a) Most time consuming installation to construct.

b ) The slowest installation for climbers to negotiate.

c) Higher chance of injury due to increased fall factor.

TRANSITION: Now that we discussed the different types of cliff assault ropes, are there any questions? Let's now discuss the construction of the cliff assault ropes.

3. (15 Min) CONSTRUCTION OF CLIFF ASSAULT ROPES. The difficulty of the terrain will determine what type of rope installation will be utilized.

a. Simple Fixed Rope. This is the quickest and easiest of the installations. There are



two methods to establish this installation.

**1 )** Coiled Rope Method.

- a)** A climbing team will assemble at the bottom of their assigned climbing lane.
- b )** The lead climber will begin climbing up the obstacle with a coiled static rope on his body. The #2 climber will provide security.
- c)** Once on top, the lead climber will locate a suitable anchor point and uncoil the rope.
- d )** The lead climber will attach the static rope to the anchor point with an appropriate anchor knot.
- e)** He will then deploy the rope down the obstacle.
- f )** The #2 climber will ensure that there is enough rope touching the deck.
- g)** The #2 climber ascends the route and ensures the rope is on the correct route.

**2 )** Trail Rope Method.

- a)** A climbing team will assemble at the bottom of their assigned climbing lane.
- b )** The number #2 will back stack a static rope while the lead climber visually inspects designated route and provide security.
- c)** The lead climber will attach the static rope to his harness.
- d )** The lead climber will begin climbing up the obstacle while the #2 climber provides security.
- e)** The lead climber will locate a suitable anchor point and attach the static rope to it with an appropriate anchor knot.
- f )** The #2 climber will ensure that there is enough rope touching the deck.
- g)** The #2 climber ascends the route and ensures the rope is on the correct route.

**b.** Semi-Fixed Rope. Establishing this installation is the same as with the simple

fixed except:

1 ) The #2 will anchor and tighten the bottom of the rope before climbing up.

c. Fixed Rope. This installation is more time consuming to establish because of the intermediate anchor points but it provides extra protection against falls.

1 ) The assault climber picks a route and the climbing team sets up for a two party climb.

2 ) Before the lead climber begins to climb he will flake out a static rope and tie one end of the static rope into the back of his harness with a figure of eight loop.

3 ) The lead climber begins two party climbing, placing protection where needed. He will also ensure that he clips the static rope into each piece of protection along with the climbing rope.

4 ) The lead climber must always keep in mind that other less skilled climbers will be ascending this route. Factors to be considered while positioning the rope in relationship to the other climbers are:

a) The rope is positioned approximately waist high.

b) The climbers should not be forced to cross the rope at any point once it is tightened.

5 ) Natural anchor points can also be used as intermediate anchor points.

#### ARTIFICIAL AND NATURAL ANCHOR POINTS

6 ) Once on top, the lead climber will remove the static rope from his harness and anchor it off using an appropriate anchor knot. The lead climber will either tie himself off or move further than 10 feet away from the cliff face. The lead climber is now off climb and will give the appropriate signal to the #2 climber.

7 ) When the #2 climber gets the "off climb" signal from his partner, he will break down the belay stance and untie from the dynamic climbing rope.

8 ) At this point the lead climber will pull up the dynamic rope and coil it. Once the rope is coiled the lead climber will go report to the senior assault climber for follow on mission.

9 ) The #2 climber will find the end of the static rope and tie a figure of eight knot in it. The rope will then be attached to the first piece of pro not more than waist high.

10 ) With a Type II cordage, the #2 climber will tie an end of the line prusik knot onto the static rope. The running end of the cordage will be attached to his hard point

utilizing a locking carabiner.

**11 )** The #2 climber will begin to climb the route, sliding his prusik up the rope as he climbs to protect himself in case of a fall.

**12 )** The static rope will be secured to each piece of protection, also referred to as intermediate anchor points. The #2 should remove any runners the lead climber placed unless needed to direct the rope. This is accomplished by tying the static rope to the piece of protection's carabiner using the slip figure eight, clove hitch, or figure of eight loop knot.

**NOTE:** By anchoring the rope at the intermediate anchor points, each section of rope is made independent of the others. Should one section fail, the other sections remain intact. All intermediate anchor point failures should be reported immediately to the installing unit and fixed promptly.

**13 )** The #2 will ensure that there is no slack between each intermediate anchor point.

**14 )** When the #2 climber reaches the top, all slack should be taken out at the top anchor point and reattached, ensuring that the static rope is as tight as possible.

**NOTE:** If the route is more than one pitch, the same procedures will be followed as mentioned above with the incorporation of a multi-pitch climb. The #2 climber will be responsible for trailing an additional static rope. When he reaches the lead climber's belay stance, their roles switch. It is the responsibility of the climber in the belay stance to adjoin the two static ropes together.

**d. Assault Lane.** This is an alternative method that can be used in place of a fixed rope when speed is essential for installation and recovery. This installation is established in the same manner as the fixed rope except:

**1 )** The intermediate anchors are not tied into the static rope.

**2 )** The rope can be tensioned at either the top or the bottom, preferably from the bottom.

**TRANSITION:** Now that we have discussed the different types of assault ropes, let us talk about how to ascend them.

**4. (10 Min) ASCENDING CLIFF ASSAULT ROPES.** Each rope installation requires different techniques for ascending. Proper commands or signals should be disseminated within a unit before ascending assault ropes. Gloves will not be worn during the ascent because this may give off a false sense of grip on the rope.

**a. Ascending Simple Fixed Ropes.** This is accomplished using the Hand-over-Hand Method.

**1 )** Straddle the rope with your legs.

2 ) Grip the rope palms down, thumbs toward your body.

3 ) Walk up the slope pulling with your arms while twisting the hands inward. This will create a bind between your grip and the rope.

### ASCENDING A SIMPLE FIXED ROPE INSTALLATION

b. Ascending Semi-Fixed Ropes. This is accomplished using the Safety Prusik Method.

1 ) With a Type II cordage, the climber will tie a prusik knot onto the static rope.

2 ) The running end of the cordage will be attached to the climber.

3 ) The climber will begin to climb the route, sliding his prusik up the rope as he climbs to protect himself in case of a fall.

c. Ascending Fixed Ropes and Assault Lanes. This is accomplished by using a safety line attached to the body.

1 ) Tie a bowline around the chest using a sling rope ensuring that both pigtails are at least arm's lengths.

2 ) At the end of each pigtail, tie a figure-of-eight loop.

3 ) Place a locking or non-locking carabiner into each of the figure-of-eight loops.

4 ) At the bottom of the fixed rope installation, clip both carabiners onto the rope and begin climbing. If using locking carabiners, it is not essential to lock the carabiners.

5 ) Upon reaching an intermediate anchor point, unclip one of the carabiners from the rope and reattach it to the rope above the anchor point. Repeat this same procedure with the second carabiner.

**NOTE:** Never allow more than one person between each intermediate anchor point.

6 ) This technique is repeated at each intermediate anchor until the climber tops off.

TRANSITION: Are there any questions on how to ascend an assault rope? Once the rope is up, it must be maintained to prevent a catastrophic failure of the system.

5. (5 Min) **MAINTENANCE OF A FIXED ROPE.** There are two criteria in the maintenance of fixed ropes.

- a. All assault rope installations should be buffed at points of abrasion.
- b. All assault rope installation anchors should be inspected periodically for accidental dislodging, walking of cams or improper direction of pull.
- c. All discrepancies should be reported immediately to the assault climbers for repair.

TRANSITION: Are there any questions over the maintenance of fixed ropes? Let us now talk about clearing the route.

**6.** (15 Min) **CLEARING THE ROUTE.** Once all the climbers have ascended the cliff it is necessary to dismantle the fixed rope to retrieve all the equipment and rope. Various methods may be used to dismantle the fixed rope depending on whether clearing the route from the top or the bottom.

a. Rappel Method. This method is used when clearing the route from the top.

1 ) The climbing team establishes a rappel line using the climbing rope.

2 ) The climber will descend the rappel line using the first man down technique.

3 ) When he reaches an intermediate anchor point he will hang on the prusik and untie the fixed rope from the protection.

4 ) The climber will remove the protection and stow it away.

5 ) The climber will continue to clear the entire lane in this manner.

6 ) If the climber needs to ascend the cliff, he may be top roped up by his climbing partner.

b. Safety Prusik Method. This method can be used when clearing the route from the bottom or the top.

1 ) From the bottom:

a) The climbing team establishes a rappel line using the climbing rope.

b ) The climber will descend to the bottom of the obstacle using the first man down technique.

c) The climber will remove the bottom anchor and attach himself to the rope with a safety prusik.

d ) The climber will ascend the rope by sliding the safety prusik up as he climbs to protect himself in case of a fall.

e) When he reaches an intermediate anchor point he will untie the fixed rope from the protection.

f) The climber will remove the protection and stow it away.

g) The climber will continue to clear the entire lane in this manner.

2) From the top:

a) The climber must create some slack in the lane by adjusting the top anchor point.

b) The climber will descend the fixed rope lane using the first man down technique.

c) When he reaches an intermediate anchor point he will hang on the prusik and untie the fixed rope from the protection.

d) The climber will remove the protection and stow it away.

e) The climber will continue to clear the entire lane in this manner.

f) If the climber needs to ascend the cliff, he may be top roped up using the static rope he just unfixes.

c. Top Rope Method. This method is used when clearing the route from the bottom.

1) The climbing team establishes a top rope.

2) The one climber clears the route while the other climber belays him.

TRANSITION: Are there any questions over clearing the route? If not, let us discuss cable ladders.

7. (15 Min) CABLE LADDERS. The cable ladder is constructed with stainless steel cables and aluminum crossbars, which are also known as rungs. Each cable end has a steel ring (eyelet) large enough to accommodate the largest carabiner in the MAC Kit. These rings allow cable ladders to be connected to each other. The cable ladder is also referred to as a caving ladder.

a. Site Selection. When selecting a ladder site consider these four factors:

1) There must be sound anchor points located at the top and bottom of the ladder.

2) You must be able to anchor the ladder along the route to keep it from swaying.

3) There must be suitable loading and unloading platforms.

**4** ) Cable ladders provide excellent protection in rock books, chimneys and overhangs.

**NOTE:** Cable ladders should be set up starting from the top anchor.

**b.** Ladder Installation Using Natural Anchors.

**1** ) Ensure that there are two sound anchor points located at each end of the ladder.

**2** ) With one end of a sling rope (or 1" tubular nylon tape), tie an appropriate anchor knot around a sound anchor point.

**3** ) With the other end of the sling rope tie a round turn and two half hitches onto a carabiner attached to the eyelet of the ladder. This knot is utilized since it is easy to adjust.

**4** ) Do the same to the opposite eyelet, pulling tightly enough so that there is no slack between the eyelets and the anchor points.

**5** ) Deploy the cable ladder down the obstacle.

**6** ) The bottom of the cable ladder can be secured in the same manner as the top. If the ladder is longer than the obstacle, it can be secured with a sling rope by:

**a** ) Tying a figure of eight loop at one end of the sling rope and clipping a locking carabiner into the loop.

**b** ) Attach the locking carabiner to the ladder by placing it around the cable and above a rung.

**c** ) Tie the sling rope off to a sound anchor point using a round turn and two half hitches. This knot is used because since it is easy to adjust.

**7** ) If intermediate anchors are needed on the route of the ladder, make sure each side of the ladder has equal tension.

**8** ) The ladder can be tightened from top or bottom, if needed. Use an appropriate anchor knot at the anchor, then tie a round turn (or slip 8) on the carabiner, tighten, and tie off with 2 half hitches.

**c.** Ladder Installation Using Artificial Anchors.

**1** ) Two pieces for artificial protection will be used for each eyelet of the cable ladder.

**2** ) Locate the middle of a sling rope (or a 1" tubular nylon tape) and tie a figure of eight loop and clip a carabiner through the loop.

- 3 ) Attach the carabiner to the ladder's eyelet.
- 4 ) Secure each sling rope's pigtail to its own piece of protection with a round turn and two half hitches. This knot is utilized since it is easy to adjust.
- 5 ) Do the same to the opposite eyelet, pulling tightly enough so that there is no slack between the eyelets and the anchor points.
- 6 ) Deploy the cable ladder down the obstacle.
- 7 ) The bottom of the cable ladder can be secured in the same manner as the top. If the ladder is longer than the obstacle, it can be secured in the same method as discussed earlier. The ladder can be tightened, if needed, as discussed above.

### INSTALLATION OF A CAVING LADDER

**NOTE:** The ladder can be tightened from either the top or the bottom so it can remain as rigid as possible.

**TRANSITION:** Are there any questions about the installation of cable ladders? If not, let us discuss ascending the cable ladders.

8. (10 Min) **ASCENDING THE CABLE LADDER**. This is done by one method or a combination of several. The following are techniques that can be used:
  - a. Climb as any other type of ladder.
  - b. Climb with one arm and one leg on each side of the ladder. Ensure that the outside foot is placed in the rung toe first while the inside boot is placed in heel first.
  - c. Concentrate on using your leg muscles more than your arms.
  - d. When climbing up a steep slope, climb hand over hand with the legs straddling the ladder, walking up the slope. This is similar to climbing a simple fixed rope.

### ASCENDING A CABLE LADDER

- e. Safety being a main concern, the climber must be protected as he ascends. This may be accomplished by:
  - 1 ) The Top Rope Method.
  - 2 ) The Safety Prusik Method. By installing a semi fixed rope parallel to the ladder, the climber can use a safety prusik to ascend the cable



ladder.

**NOTE:** The top anchor point for the method of protecting the climber will be separate from that of the top anchor point for the ladder.

**TRANSITION:** Now that we have discussed cable ladders, are there any questions? These are the techniques used to conduct cliff assaults. The actual conduct will be discussed in another class. If you have no questions for me, then I have some for you.

**PRACTICE** (CONC)

- a. The students will construct a fixed rope installation.

**PROVIDE HELP** (CONC)

- a. The instructors will assist the students when necessary.

**OPPORTUNITY FOR QUESTIONS** (3 Min)

**1. QUESTIONS FROM THE CLASS**

**2. QUESTIONS TO THE CLASS**

- Q. What are the three types of fixed ropes?

- A. (1) Simple Fixed Rope.  
(2) Semi-Fixed Rope.  
(3) Fixed Rope.

- Q. What types of knots can be used at intermediate anchor points of a fixed rope installation?

- A. Figure 8, Slip Figure 8, Clove Hitch
- B. How does the climber tie into a fixed rope installation?
- A. With a round the chest bowline with a figure of eight loop at each end of the pigtail. A carabiner will be clipped into each loop. This is known as a safety line.

**SUMMARY** (2 Min)

- a. During this class we have covered simple fixed rope, semi-fixed, fixed rope and the cable ladder installations.
- b. Those of you with IRF's please fill them out at this time and turn them in to the instructor. We will now take a short break.

UNITED STATES MARINE CORPS  
Mountain Warfare Training Center  
Bridgeport, California 93517-5001

SML

ACC

02/20/02

**LESSON PLAN**

**CLIFF RECONNAISSANCE**

**INTRODUCTION**

(5 Min)

- 1. GAIN ATTENTION.** The invasion of Normandy didn't happen without extensive reconnaissance of the beach and cliff areas. This vital information helped the assault forces plan, prepare, and train for the steep cliffs that were awaiting them. As an assault force, Commanders cannot afford to waste precious moments on the beach waiting to gather information about the cliff and be more vulnerable than they already are.
- 2. PURPOSE.** The purpose of this period of instruction is to introduce to you to cliff reconnaissance. This lesson relates to cliff assault and fixed ropes.
- 3. INTRODUCE LEARNING OBJECTIVES**
  - a. TERMINAL LEARNING OBJECTIVE.** In a summer mountainous environment and given a designated cliff, conduct a cliff reconnaissance, in accordance with the references.
  - b. ENABLING LEARNING OBJECTIVES.**
    - 1. )** Without the aid of reference, state in writing, the equipment needed to construct a cliff sketch, in accordance with the references.
    - 2. )** Without the aid of reference, list in writing, the marginal information required on a cliff sketch, in accordance with the references.
    - 3. )** Given a designated cliff and necessary equipment, construct a cliff sketch, in

accordance with the references.

4. Without the aid of reference and given a diagram, list the basic symbols used on the cliff sketch, in accordance with the references.

# 31

5. Given the proper format and needed information, prepare a cliff report, in accordance with the references.

4. **METHOD/MEDIA.** The material in this lesson will be presented by lecture. You will practice what you have learned during upcoming field training exercises.

5. **EVALUATION.** You will be tested later in this course by performance evaluation.

TRANSITION: If there are no questions, let's start by defining exactly what reconnaissance is.

## BODY

(55 Min)

1. (5 Min) **RECONNAISSANCE.** Conducting a cliff assault is a dangerous undertaking. Without extensive reconnaissance of the intended site, the operation will almost be doomed to fail. The more information available to the raid force commander the better the chances of success. The following units are capable of conducting cliff site reconnaissance:
- a. Force Reconnaissance Company. This is a MEF level asset whose mission is to conduct pre-assault and deep post-assault reconnaissance and surveillance in support of the Landing Force Commander. Normally there will be one platoon assigned to each MEU (SOC) deployed. This unit will normally have organic Assault Climbers or M7A qualified Mountain Leaders.
  - b. Reconnaissance Company (Division). This is a Division level asset whose mission is to conduct reconnaissance and surveillance in support of the Marine Division and its subordinate elements. Normally there will be one platoon assigned to each MEU (SOC) deployed. This unit will possibly have organic Assault Climbers or M7A qualified Mountain Leaders.
  - c. Surveillance and Target Acquisition Platoon (STA). This is a BLT asset, normally composed of MOS 8541 trained snipers whose mission is to conduct close reconnaissance for the Battalion Commander and deliver long range precision fire on selected targets. Normally, this element is not employed independent of BLT operations and lack much of the organic support needed for insertion into the operational area when compared to the Reconnaissance

Units.

- d.** Qualified Small Boat Company Scout Swimmers. They are trained to conduct cliff reconnaissance as the boat company often has the primary mission of conducting an amphibious cliff assault.
- e.** SEALS. MEU (SOC) will deploy with elements from NAVSPECCWARGRP.
- f.** Others. Additional units in the theater of operation may consist of Ranger Pathfinder Platoons and Special Forces A Teams.

TRANSITION: Now that we are familiar with what units are qualified to conduct site reconnaissance, let's discuss general considerations of cliff reconnaissance.

**2.** (10 Min) CLIFF RECONNAISSANCE. As covered in the Cliff Assault class, the assault force and its climbers must be prepared to overcome the cliff by whatever means necessary. There are many factors, which drive the reconnaissance effort in support of MEU (SOC) operations. Normally, this mission can be assigned to any one of the units mentioned above at the MEU Commander's discretion. The following are offered as general considerations for conduct of a cliff reconnaissance and are not meant to dictate current unit SOP.

- a.** Determine mission feasibility at the mission planning stages (METT) taking into account the enemy situation, capabilities, and probable courses of action (KOCOA, DRAW-D, SALUTE-R).
- b.** Determine equipment requirements and the assault forces current capabilities. (i.e. is there pre-training or sustainment training required before mission execution.)
- c.** Request an aerial reconnaissance of the area.
- d.** At a minimum, conduct a detailed map reconnaissance. Request to use current MEU (SOC) reconnaissance assets if available.
- e.** The unit conducting the reconnaissance should be thoroughly familiar with assault climber operations and the assaulting units capabilities.

**1.** If the unit conducting the reconnaissance does not have a qualified Mountain Leader or an assault climber they should bring one with them.

**2.** Ideally, any qualified M7A Mountain Leader or current assault climber should lead this effort. This will provide on site expertise to provide a clear picture of the obstacle to be crossed, identify possible climbing points, equipment requirements, as well as a tentative time estimate.

**f.** Gather essential data.

- (1)** If the unit conducting reconnaissance is not familiar with this type of mission, they must be thoroughly briefed on the specific information required by the assault climbers.
- (2)** A face-to-face coordination with the recon team leader is highly recommended.
- (3)** The reconnaissance prep should include, but is not limited to sketches, photographs, or any other items of significance. Don't rule out uncommon sources like tourist maps or photos from submarines. These are very good for planning and navigation.
- (4)** The information must be reported in a timely manner in order to prepare the assault force.

**g.** On site observations.

- (1)** Identify top and bottom anchor points.
- (2)** Identify top and bottom rally points.
- (3)** Identify probable lanes for climbing and establishment of rope installations.
- (4)** Identify weakness in the cliff face such as chimneys, overhangs, rotten rock, etc...
- (5)** Identify natural animal habitats such as dens, caves and nests. Startling the animals may warn off the enemy of a disturbance of the cliff face.
- (6)** Identify possible rock slide/avalanche sites.
- (7)** Check for the feasibility of fire support.

TRANSITION: Now that you know some of the basic considerations in conducting this mission, let's look at one of the tools of this type of reconnaissance, the cliff sketch.

**3.** (5 Min) **OPERATION SECURITY.** Operational security is of utmost importance. The following are considerations to be taken:

- a.** The reconnaissance element should not climb the intended cliff breach points. This could compromise the plan causing a disastrous loss of surprise for the assaulting unit.
- b.** If the recon unit is to remain in place, surveillance of the breach

points and likely avenues of approach should be established.

- c. The unit should facilitate the arrival of the assault force and be prepared to assist in any way possible.

4. (10 Min) **CLIFF SKETCH.** A cliff sketch is a pictorial representation of the cliff in elevation and perspective as seen from one point of observation. It will contain a horizon line and intervening features. It is rapidly made and easily read and understood. A proper cliff sketch will have enormous value to the raid force commander and his assault climbers.

- a. Equipment. The following equipment will assist in constructing the cliff sketch:

- ① Compass
- ② Binoculars equipped with a mil scale
- ③ Sketch pad
- ④ Soft pencil
- ⑤ Ruler
- ⑥ Digital Camera

- b. Marginal Information. The following information is placed on the sketch after indicating the reference line and before conducting the sketch:

- 1 ) Sketchers name, rank, and unit
- 2 ) Date of sketch
- 3 ) Sketchers location (8 digit grid at a minimum)
- 4 ) Direction of view (in degrees magnetic)
- 5 ) Magnetic north arrow
- 6 ) Scale (if used/known)

- c. Construction.

- ① Study the landscape to distinguish prominent terrain features in relation to each other. This should be done in conjunction with your military map.

**(2)** Select a reference point. The point should be permanent and conspicuous. This is the base that the features of your sketch will be drawn from.

**(3)** Establish a scale. The cliff sketch is a panoramic or birds eye view of the cliff. To maintain a correct relationship between objects and features, a proportion must be established. One method of scale is the 15 inch method:

**a)** Attach a 15 inch piece of cord to your ruler and hold one end in your teeth.

**b )** Hold the ruler at eye level, each 3/4" increment is equal to 50 mils in width.

**c)** Utilizing a scale will increase the accuracy of the sketch.

**d.** Basic symbols. There are seven basic symbols used on the cliff sketch, each defines a characteristic that is of importance to the assault climber.

**(1)** THIN CRACK

**(2)** THICK CRACK

**(3)** LEFT FACING CRACK

**(4)** RIGHT FACING CRACK

**(5)** OVERHANG

**(6)** LEDGE

**(7)** CHIMNEY

**(8)** SLAB

**(9)** RAMP

**(10)** CHUTE

#### **ILLUSTRATIONS OF BASIC SYMBOLS**

Note: Ramp, Slab, and Chute can be written on the sketch, include the dimensions (width, depth, height) in order to know the number of lanes possible.

**NOTE:** Only details that are of military importance should be added. Details should not be added simply to fill up space or improve the appearance of the sketch.

**TRANSITION:** The cliff sketch is a great tool to the commander on the ground or at the objective area, but how will we get information back to the assault force on the ship before we depart on the mission. Next we will discuss the cliff report.

**5.** (10 Min) **CLIFF REPORT.** The cliff report contains thirteen lines, Alpha through Mike. Each of the lines will give information about a specific aspect of the cliff and the surrounding area. The following is provided in the event that a recon team is reporting directly to the assaulting unit and not their SARC.

**a.** LINE ALPHA: Line Alpha indicates the units of measure to be used throughout the report.

UNIT OF MEASURE	NUMBER CODE
Meters	1
Yards	2
Feet	3

**b.** LINE BRAVO: Date / time report completed.

**c.** LINE CHARLIE: Cliff location. Given at cliff center and expressed as a minimum 8 digit grid over a secure net or encrypted utilizing the AKAC 874.

**d.** LINE DELTA: Width of the cliff head, expressed in the units of measure stated in LINE ALPHA.

**e.** LINE ECHO: Cliff height, expressed in the units of measure stated in LINE ALPHA.

**f.** LINE FOXTROT: Obstacles at the base of the cliff. This line can use multiple codes.

OBSTACLE	LETTER CODE	NUMBER CODE	TYPE
Natural	A	1	Rocks
		2	Stream / River



		3	Trees / Vegetation
		4	Ditches
		5	Snow / Ice
Manmade	B	1	Buildings
		2	Fences
		3	Pylons / Wires
		4	Poles / Masts
		5	Others

**g.** LINE GOLF: Rock type, if known.

TYPE	NUMBER CODE
Granite	1
Basalt	2
Lava	3
Sandstone	4
Steep earth	5
Unknown	6

**h.** LINE HOTEL: Military classification of climbs, if determined.

CODE	DESCRIPTION
Easy	50-60 degrees, freeable, good pro placement
Moderate	60-70 degrees, good pro placement, medium -large pro
Difficult	70-80 degrees, marginal pro placements, overhangs
Severe	80-90 degrees, run-outs or unprotectable, overhangs

**i.** LINE INDIA: This line will identify hazards on the cliff face.

HAZARD	NUMBER CODE
Rockfall	1
Water	2
Snow / Ice	3
Vegetation	4
Other	5

**j.** LINE JULIET: This line will identify the number and types of tactical lanes, which can be constructed. This line may contain more than one code as applicable.

LANE TYPE	LETTER CODE
Simple fixed	A
Fixed	B
Top rope	C

Cable ladder	D
Vertical hauling line	E
Suspension traverse	F

- k.** LINE KILO: Is an A-frame needed? YES or NO
- l.** LINE LIMA: Enemy Situation. Given in the SALUTE-R format for any current enemy reports that may affect the cliff assault or are pertinent.
- m.** LINE MIKE: Remarks / comments. Identifies any data that is essential but not covered in the above lines.

**6.** (5 Min) **CLIFF REPORT EXAMPLE.** The following is an example of a cliff report. It is based on NATO report formats utilized by reconnaissance units. The advantages to this style of report are the encryption of the pertinent information and the ability to rapidly transmit the data by radio communications. The disadvantage to this style is that the receiver of the report must be thoroughly versed in the report and how to decipher the information.

- a.** Recon Team: Kilo One Tango this is Golf Seven Delta, stand by for CLIFFREP, over.

LINE ALPHA	3
LINE BRAVO	180800ZJAN98
LINE CHARLIE	MG67890898
LINE DELTA	250
LINE ECHO	40
LINE FOXTROT	2,4 A; 2 B
LINE GOLF	1
LINE HOTEL	Moderate
LINE INDIA	4
LINE JULIET	6 C, 3 D, 1 F
LINE KILO	Yes
LINE LIMA	None
LINE MIKE	None

- b.** This report describes a cliff in feet that was reconnoitered at 0800 on 18 Jan 2000. The cliff is located at grid MG67890898 and is 250 feet wide at the base. The cliff is 40 feet high and has a ditch, stream and fence in the area surrounding the base. It is made of granite and is a moderate climb. There is vegetation on the cliff face with 6 top rope lanes, 3 ladder lanes, and 1 suspension traverse site. An A-frame is needed to bring up equipment and no enemy activity was noted.

**TRANSITION:** Properly done the cliff report and cliff sketch can greatly help with the mission

at hand. We have discussed the types of reconnaissance, cliff reconnaissance, cliff sketch, and the cliff report. Are there any questions?

### **PRACTICE**

- a.** Students will practice basic cliff reconnaissance utilizing reports and cliff sketches

### **PROVIDE HELP**

- a.** Instructors will assist the students when necessary.

### **OPPORTUNITY FOR QUESTIONS**

(3 Min)

#### **1.** QUESTIONS FROM THE CLASS

#### **2.** QUESTIONS TO THE CLASS

Q. What are the basic symbols used on a cliff sketch?

- A. (1) Thin Crack
- (2) Thick Crack
- (3) Left Facing Book
- (4) Right Facing Book
- (5) Overhang
- (6) Ledge
- (7) Chimney
- (8) Ramp
- (9) Chute
- (10) Slab

### **SUMMARY**

(2 Min)

- a.** During this period of instruction, we have discussed the types of reconnaissance, the cliff reconnaissance itself, the cliff sketch, and the cliff report. These areas must be highly accurate in order for a good cliff assault to be planned.
- b.** Those of you with IRF's please fill them out and give them to me. Everyone else take a five minute break.

**UNITED STATES MARINE CORPS**  
Mountain Warfare Training Center  
Bridgeport, California 93517-5001

SML  
SMO  
ACC  
02/20/02

**LESSON PLAN**

**CLIFF ASSAULT**

**INTRODUCTION**

(5 Min)

- 1. GAIN ATTENTION.** For a Marine, there is almost no such thing as impassible terrain. Even cliffs can be surmounted and military operations can be conducted if the techniques are properly learned. Techniques for cliff assaults were developed and refined by the Royal Marine Commandos during World War II for amphibious raids; but the principles apply to any cliff. This class will introduce you to the principles of cliff assault. You will be applying these principles later in both day and night exercises while a member of this course.
- 2. OVERVIEW.** The purpose of this period of instruction is to familiarize the students with the techniques and basic procedures of conducting a cliff assault. This lesson relates to all other lessons on mountain movement.

**INSTRUCTOR NOTE:** Have students read learning objectives.

**3. INTRODUCE LEARNING OBJECTIVES**

**a. TERMINAL LEARNING OBJECTIVE.** In a summer mountainous environment and given a cliff face, conduct a cliff assault, in accordance with the references.

**b. ENABLING LEARNING OBJECTIVES**

**1 )** Without aid of the reference, list in writing the planning framework considerations when conducting a cliff assault, in accordance with the reference.

**2 )** Without aid of the reference, list in writing the tactical considerations when conducting an amphibious cliff assault, in accordance with the reference.

**3 )** Without aid of the references, list in writing the four different techniques that may be employed to move personnel/equipment conducting a cliff assault up the cliff face, in

accordance with the references.

4. Without the aid of references, describe in writing the five phases of a cliff assault, in accordance with the reference.

4. **METHOD/MEDIA.** The material in this lesson will be presented by lecture and demonstration. You will practice what you have learned in upcoming field training exercises. Those of you with IRF's please fill them out at the conclusion of this period of instruction.

5. **EVALUATION.**

- a. SML - You will be tested by a written examination and a performance evaluation.
- b. ACC - You will be tested by a written exam and a performance evaluation during your company's cliff assault.
- c. SMO - You will be evaluated by a performance evaluation as a company during the cliff assault.

TRANSITION: Are there any questions over the purpose, learning objectives, how the class will be taught or how you will be evaluated? This class will not just be in the classroom; you will also have the opportunity to practice it in the field, and perhaps someday in combat. With that in mind, let's look at the planning framework.

**BODY**

(90 Min)

1. (5 Min) **PLANNING FRAMEWORK.** A cliff assault is a thoroughly planned action on a known danger area. The unit's mission is the raid beyond the cliff, not climbing the cliff itself. Beware of losing focus on the end state. Once the commander decides to execute a cliff assault, his planning is framed by the following:

- a. Surprise is paramount and silence must be kept to attain surprise.
- b. Speed is essential, and all ropes available must be used.
- c. The cliff head must be well organized.
- d. Initially, the raiding party is very vulnerable.

TRANSITION: Are there any questions over the planning framework? Let us now discuss the reconnaissance considerations.

2. (5 Min) **RECONNAISSANCE CONSIDERATIONS.** Recon teams should take an experienced assault climber team with them on insertion to ensure that:

- a. Climbing points can be established on the vertical obstacles that are within the

unit's ability.

- b.** Suitable top and bottom anchors.
- c.** Be able to direct assault climbers to specific routes upon arrival.

TRANSITION: Now that we have discussed the reconnaissance considerations, are there any questions? Let us now talk about the tactical considerations.

**3.** (5 Min) **TACTICAL CONSIDERATIONS.** If an enemy objective is in close proximity to a cliff-head, it is possible that defensive forces consider the cliff an obstacle, thus focusing their security to other more vulnerable areas. However, if the objective is outside small arms range from the cliff, the enemy will likely defend it in a 360-degree fashion. If this is the case, you have fatigued the assault unit with the climb while not achieving the desired surprise. An objective that is near the cliff assault site offers these advantages:

- a.** An enemy could assume that the cliff is not crossable and therefore is a protected "wall" which he can put his back against. Therefore concentrating his defenses out board from the cliff toward more likely avenues of approach.
- b.** The cliff edge to the objective distance is within our mortar range. Thus the assault unit does not have to expend the time and energy to haul mortars, crews and ammunition up the cliff to ensure fire support for their attack. Without a suitable platform, this advantage is void.
- c.** The enemy security forces may not be comfortable looking over the edge of a cliff under less than ideal conditions, potentially creating a gap in security that the assault unit can exploit.

TRANSITION: Are there any questions over the tactical considerations? Let us now discuss the possibility of using deception.

**4.** (5 Min) **DECEPTION PLAN.** Use noise factors and diversionary attacks.

- a.** Rivers or ocean waves breaking at the base of cliffs are common and mask the noise of a cliff assault very well.
- b.** Weapons fire and impacts from supporting arms can also mask the noise of a cliff assault, but it can also put the enemy on alert.
- c.** Shelling on or near enemy positions on a regular basis at the same time over a period of days may cause the enemy to become accustomed to the disturbance and be less vigilant during these times.

**NOTE:** Do not plan to use fires on or near the cliff heads because this can render the cliffs dangerous and unstable due to loose rocks and rock fall.

- d.** Use diversionary attacks by ground, air or indirect fire from multiple directions.
- e.** The cliff assault itself can be used as the diversionary attack.

TRANSITION: Are there any questions about the considerations of a deception plan? If not, let's talk about the use of communications.

**5.** (5 Min) **COMMUNICATIONS.** Use wire as the primary mode and radio as the alternative means to minimize radio traffic and ensure good communications.

- a.** When using intra squad radios, caution must be taken because they have no crypto capability although they operate on military band only.
- b.** A no Comm plan should be designed on standard signals as per the unit's SOP to include a few additional signals to deal specifically with the cliff assault.
- c.** Key personnel should have a radio operator and/or runner.

TRANSITION: Are there any questions over communications? Let us now discuss the Fire Support Plan.

**6.** (5 Min) **FIRE SUPPORT PLAN.** Develop the Fire Support Plan using traditional deliberate attack parameters. When preparing a plan, consider the following:

- a.** Use of the attacking unit's organic mortars first.
- b.** Use artillery, if in range of the cliff assault.
- c.** Use of the Forward Air Controller for rotary and fixed-wing aircraft.
- d.** Naval Gun Fire can be utilized but be aware that it cannot cover reverse slopes.

TRANSITION: Are there any questions over the planning of fire support? There are numerous considerations to look at if the cliff assault is being conducted during an amphibious assault.

**7.** (5 Min) **AMPHIBIOUS CONSIDERATIONS.** The amphibious considerations are:

- a.** Advance force reconnaissance operations should be employed.
- b.** Hydrographic surveys/confirmatory beach reports should be conducted.
- c.** All landing vehicles/crafts must be spread loaded.

- d.** Debarkation must be done quickly.

TRANSITION: Now that we have discussed planning, are there any questions? Once reconnaissance has confirmed the route and the plan is moving along, the planner must turn to organizing his force.

**8.** (5 Min) ORGANIZATION.

- a.** 1<sup>st</sup> Wave. This wave would be organized with 18-24 assault climbers (depending on size of unit), Plt / unit commanders and cliff head security (top and bottom).

**NOTE**: Additionally within the first wave, a company-sized unit may want to designate a vertical hauling line/suspension traverse team to establish these installations on top for heavy equipment.

- b.** 2<sup>nd</sup> Wave. This would constitute the remainder of the task-organized units, the assault force and the reserves. The XO is delegated in command of the second wave and will stay at the base of the vertical obstacle until the unit has negotiated the vertical face.



- 1 ) The amount of time the unit is stationary at the vertical obstacle should be minimized. Ideally, the main second wave should move from the boat/landing craft or rally point straight into the climbing lanes (via beach master).

TRANSITION: Now that we have discussed the organization of a cliff assault, are there any questions? Let's look at some different techniques that may be used to move personnel and gear up the face of the vertical obstacle.

9. (5 Min) **ASSAULT CLIMBING TECHNIQUES**. The actual techniques used to negotiate personnel and equipment up the vertical obstacle may vary depending on a variety of factors: level of training, type of vertical obstacle to be negotiated, and/or equipment available. The following four techniques, or any combination of them may be used:
  - a. Two party climb for assault climbers, all other personnel top rope.
  - b. Two party climb for assault climbers, all other personnel go up fixed rope installations.
  - c. Two party climb for assault climbers, all other personnel/equipment utilize vertical hauling line and/or suspension traverse.
  - d. Two party climb for assault climbers, all other personnel utilize cable ladders.

TRANSITION: Are there any questions over the techniques? Now let's look at the sequence of events to be followed by each wave. Remember this is only a technique, not a principle; but it is a tested technique, and experience has shown the value of a set sequence to be followed when entering enemy territory, especially at night.

10. (25 Min) **ASSAULT SEQUENCE**. The Assault Sequence can best be understood and organized if it is broken down into five phases, with many actions and tasks taking place simultaneously within each phase.
  - a. Phase One. The first wave arrives at the cliff base.
    - 1 ) First wave moves into ORP.
    - 2 ) CHO and leaders conduct recon of proposed climbs and establishes left and right lateral limits. Easiest climbing routes are selected for leaders.
    - 3 ) The #2s prepare gear for climbing.
    - 4 ) CHO and BM place flank securities into position.
    - 5 ) Climbing teams move to designated lanes and prepare to climb.
      - a) At least one climbing team must have a radio.

- b )**All lead climbers should have NVGs, but not climb with them on.
  - c)**All lead climbers should climb with minimal gear.
  - d )**One or all of the lead climbers will carry a static rope. These are to be used for the rope installations.
  - e)**Hardest climbs go to the best teams.
- 6 )**Casevac plan is formulated and litters prepared.
- 7 )**The area that the climbers ascend is not necessary the area where climbing lanes are established. First wave must be ready to move if this is the case.

**PHASE ONE**  
**INITIAL ORGANIZATION**

- b.** Phase Two. Begins as soon as first lead climber begins to climb.
- 1 )**The first leader on top provides initial security.
  - 2 )**As soon as the remainder of the leaders top out, construction of the climbing lanes begin with the radio being passed off to the leader on security. The cliff-head is divided into sections for easier control.
  - 3 )**Communication must be established between the top and bottom of the cliff. If possible the CAC should be one of the leaders and have a radio.
  - 4 )**Emergency rappel lanes are established to provide for a quick withdrawal if the mission is compromised, a 4:1 ratio is required. These are usually single rope rappels.
  - 5 )**The #2 climbers are brought up and they should have the gear needed to begin construction of climbing lanes.
  - 6 )**The remainder of the first wave needed on top (CHO, CPNCO, security, etc...) begins to ascend as soon a climbing lane is established. All lanes must be cleared "hot" by the CHO before they are climbed by the second wave. Security is positioned by the CHO.
    - a)**CHO needs to ascend ASAP to make final decisions on location of vertical hauling lines (VHL), security, control features, etc...
  - 7 )**Assault climbers on security are relieved by designated security teams.
  - 8 )**Once on top, the Raid Force Commander (RFC) departs for the leader recon.
  - 9 )**The BM begins constructing control features at the cliff base, only when leaders have

begun to construct lanes. The BM position will be dependent on the vegetation/terrain.

- 10 ) Gear is prepared in ORP for hauling systems.
- 11 ) Vertical hauling lines and/or suspension traverse is constructed. At least one assault climber must be left on the deck to aid in the construction/operation of the VHL.
- 12 ) Lane NCOs move gear needed on top to VHL and it is taken up to cliff head.
- 13 ) Control Point NCO establishes topside control features.
- 14 ) A landline between the BM and the CPNCO is established.
- 15 ) #2 climbers climb the ladders to check for the need of intermediate anchors.
- 16 ) Once all of first wave is on top, Casevac Plan must be formulated to lower casualties, if necessary.
- 17 ) ORP may be moved closer to cliff base for better silence/security.

**PHASE TWO**  
**INITIAL ASCENT**

**c.** Phase Three. Arrival of the second wave for their ascent of the cliff.

- 1 ) Company should establish radio contact 10 minutes out.
- 2 ) Second wave establishes an ORP, preps to climb and XO makes liaison with the BM.
- 3 ) CHO is informed on the second waves' arrival and inquires of any changes in the numbers, injuries, changes in timeline, etc...
- 4 ) Company should already be broken down into climbing sticks for easier control. Each Marine is assigned an alphanumeric indicator within his element.

Example:

1 <sup>st</sup> Platoon Security Element	2 <sup>nd</sup> Platoon Assault Element
A-1 Lcpl Tooby	B-1 Pfc Brunner
A-2 Cpl Post	B-2 Lcpl Padilla
A-3 Sgt Morron	B-3 Pvt Kesl

- 5 ) Lane NCOs are stationed at the bottom of the lanes to assist Marines.
- 6 ) Marines check in with BM and give their stick number. BM does final check for proper knots/equipment. The BM will then direct the Marines to specific climbing lanes.
- 7 ) Marines with heavy loads or crew served weapons are directed to the VHL. These climbers are then directed to the climbing lanes closest to the VHL for easier recovery of their gear once on top.
- 8 ) Once on top, all Marines follow control features to the CPNCO, and give their stick number to him. The CPNCO will then direct the Marines to their new position.
- 9 ) Raid force begins to establish a 180-degree defensive perimeter and awaits return of the RFC. An option of staggering the raid force by element within the control feature is possible.
- 10 ) Once all members of the second wave are on top, the XO ascends the cliff.
- 11 ) In the event that there are missing personnel at the top, stick numbers can be checked to ensure that a Marine(s) came through the BM and the CPNCO, and that no one is still within the confines of the control features or the ORP.
- 12 ) Upon return of the RFC, he issues final orders and briefs possible shifts in his time lines, the raid force then moves out to its objective.
- 13 ) If the raid force is not withdrawing via the cliff, the first wave joins the second wave at the top of the cliff and continues on with the raid force. Options to the RFC are to either wait on the first wave to join the second wave and move out, or move without first wave and linkup at a later time.

**PHASE THREE**  
**SECOND WAVE ASCENDS**

**d.** Phase Four. Departure of the Raid Force.

(1) Approximately 15 minutes after departure of the second wave to the objective:

**NOTE:** The time hack is used for withdrawal if the mission is cancelled/compromised.

- a)** The control features, top and bottom, are removed to prevent detection.
- b )** All unnecessary equipment/personnel are moved to the cliff base.
- c)** Assault climbers begin to take down climbing lanes and establish retrievable rappel lanes. Belay men must be stationed at the cliff base for the second wave.
- d )** The VHL/ suspension traverse is left in place. The systems may be slacked or A-Frame collapsed to prevent detection.
- e)** A central point for casualties and EPWs is established and litters are prepared for possible medical evacuations.
- f )** Personnel topside form ORP and await arrival of the raid force.
- g)** Personnel at the cliff base do likewise.
- h )** CHO follows progress of raid force on radio and stays aware of situation (casualties, EPWs, changes in plan etc...).

**PHASE FOUR**  
**RAID FORCE DEPARTS**

**e.** Phase Five. Withdrawal. If the units mission dictates a withdrawal via the cliff face, the following steps should be taken:

**NOTE:** If the unit is compromised before the mission has been completed, then the tactical situation will dictate how the withdrawal will be accomplished.

**1 )** Upon contact with the raid force confirming its return:

a) Control features are re-established at the top and bottom.

2 ) Upon the re-arrival of the raid force:

a) Raid force re-establishes 180-degree defensive perimeter. Any casualties are moved to the cliff head and evacuated.

b ) Once the order to withdrawal is given, the BM prepares to receive the descending Marines. In an amphibious operation, he would call the landing craft/boats at this time.

c) Company XO is among the first to rappel down.

d ) A high concentration of automatic weapons and unit leaders are left on top.

e) Squads thin their positions with the squad leader descending last. He reports his squad departure to the CPNCO.

f ) The unit commander descends after the main body departed.

g) Once the entire second wave is down, the bulk of the first wave begins to withdrawal.

h ) Assault climbers begin to tear down the rappel lanes and VHLs/suspension traverses. All ropes are dropped to the base of the cliff and back stacked into rope bags. A-frame poles are lowered.

i ) CHO is constantly aware of the state of the cliff head.

j ) CPNCO and BM tear down their control features.

k ) Security comes in and descends the cliff via the retrievable rappel lanes.

l ) Assault climbers descend with the CAC and CHO being the last men down.

m) The retrievable rappel ropes are retrieved. Assault climbers account for all gear and personnel.

n ) Assault climbers check in with the BM and all rejoin the unit.

TRANSITION: Now that we have discussed the five phases, are there any questions? Let us talk about some general considerations.

**11. (5 Min) GENERAL POINTS.**

a. The second wave should precede the first wave with ample enough time to establish all climbing lanes and rope systems.

- b. Three climbing lanes per platoon should be established for the quickest ascent.
- c. Cable ladders should be utilized to a maximum for all climbing lanes.
- d. Communications between the CPNCO and the BM should be via landline. This is reliable and secure.
- e. Communication between the CHO, CAC and assault climbers at the cliff base should be maintained if communication assets are available.

TRANSITION: Let us now discuss other possibilities to keep in mind.

**12.** (5 Min) **CONCLUSION.** The planner should be aware, or made aware of other options and scenarios that may arise concerning the ascension of a vertical cliff by a unit. Cable ladders are an excellent means of ascending a vertical cliff, but may not always be the best method. Top ropes, fixed ropes, etc... are all viable means to move up a vertical obstacle.

- a. Another example is using the same route up. Instead of lead climbers climbing different routes up a cliff face, some leaders can climb up an easy route then establish their lanes on other sections of the cliff.
- b. Another scenario might be in which only a security element climbs on the established cable ladders on a true vertical cliff, and then moves to secure the top of the cliff where fixed ropes can be set up. This would allow for the remainder of the company to ascend quicker and easier.

TRANSITION: Now that we have discussed the five phases of the assault, are there any questions? A cliff assault is a very daring and risky undertaking, but it can also yield some great rewards by catching the enemy completely off guard.

**PRACTICE** (CONC)

- a. The students will conduct a cliff assault.

**PROVIDE HELP** (CONC)

- a. The instructors will assist the students if necessary.

**OPPORTUNITY FOR QUESTIONS** (3 Min)

**1. QUESTIONS FROM THE CLASS**

**2. QUESTIONS TO THE CLASS**

Q. What are the four planning framework considerations that must be considered when planning a cliff assault?

- A. (1) Surprise is Paramount and silence must be kept to attain it.
- (2) Speed is essential and all ropes must be utilized.
- (3) The cliff head must be well organized.
- (4) Initially, the raiding party is very vulnerable.

Q. What are four tactical considerations if the cliff assault is to be amphibious?

- A. (1) Advance force reconnaissance operations should be employed.
- (2) Hydrographic surveys, confirmatory beach reports, should be conducted.
- (3) All landing vehicles/crafts must be spread loaded.
- (4) Debarkation must be done quickly.

Q. What are the four different techniques that may be utilized to move personnel/equipment conducting a cliff assault up the cliff face?

- A. (1) Two party climb for assault climbers, all other personnel top rope.
- (2) Two party climb for assault climbers, all other personnel go up fixed rope installations.
- (3) Two party climb for assault climbers, all other personnel/equipment utilize vertical hauling line and/or suspension traverse.
- (4) Two party climb for assault climbers, all other personnel utilize rope ladders.

## **SUMMARY**

(2 Min)

- a. During this period of instruction, we have covered the tactical considerations, basics of planning and the organization of a cliff assault; also, how to conduct a cliff assault, which included the five phases of an assault.
- b. Those of you with IRF's please fill them out at this time and turn them in to the instructor. We will now take a short break.



**UNITED STATES MARINE CORPS**  
Mountain Warfare Training Center  
Bridgeport, California 93517-5001

**BIBLIOGRAPHY OF REFERENCES**

Mountain Safety

- a. TC 90-6-1, Military Mountaineering
- b. USMC Battle Skills Training Book
- c. Mountaineering, The Freedom of the Hills, 6<sup>th</sup> Edition, The Mountaineers, Seattle WA 1996.
- d. MCRP 3-35.1, Commander's Guide to Cold Weather Operations
- e. MCRP 3-35.1A, Small Unit Leader's Guide to Cold Weather Operations
- f. MCRP 3-35.2B Military Mountaineering
- g. MCWP 3-35.2, Mountain Operations
- h. The Royal Marine's Mountain and Arctic Warfare Handbook, 1972

Marine Assault Climber's Kit

- a. Marine Corps Stocklist, Marine Assault Climbers Kit MACK, SL-3-10161A
- b. Marine Assault Climber's Kit Care and Maintenance Manual

Nomenclature and Care of Mountaineering Equipment

- a. Marine Assault Climber's Kit Care and Maintenance Manual
- b. MCRP 3-35.2B Military Mountaineering
- c. TC 90-6-1, Military Mountaineering
- d. Mountaineering, The Freedom of the Hills, 6<sup>th</sup> Edition, The Mountaineers, Seattle WA 1996.

Rope Management

- a. MCRP 3-35.2B Military Mountaineering
  - b. TC 90-6-1, Military Mountaineering
- c. Mountaineering, The Freedom of the Hills, 6<sup>th</sup> Edition, The Mountaineers, Seattle WA 1996.
- d. Luebben, Craig, Knots for Climbers-1995, Chockstone Press Inc, Evergreen, CO
- e. Wheelock, Walt, Ropes, Knots and Slings for Climbers-1992, La Siesta Press, Glendale, CA
- f. Padgett, Allen; Smith, Bruce, On Rope-4<sup>th</sup> Printing, National Speleological Society, 1992.

### Mountain Casualty Evacuation

- a. MCRP 3-35.2B Military Mountaineering
  - b. TC 90-6-1, Military Mountaineering
  - c. M. J. Lentz, Mountaineering First Aid, Third Edition.
- d. Manual of US Cave Rescue Techniques-2<sup>nd</sup> Edition, Speleological Society, 1988

### Natural and Artificial Anchors

- a. MCRP 3-35.2B Military Mountaineering
  - b. TC 90-6-1, Military Mountaineering
- c. Mountaineering, The Freedom of the Hills, 6<sup>th</sup> Edition, The Mountaineers, Seattle WA 1996.
- d. Long, John, Climbing Anchors-1993, Chockstone Press Inc, Evergreen, CO
- e. Robbins, Roy, Basic Rock Craft-1971, La Siesta Press, Glendale, CA

### Mechanical Advantage

- a. MCRP 3-35.2B Military Mountaineering
- b. TC 90-6-1, Military Mountaineering
- c. Bechdel, Les; Ray, Slim, River Rescue 2<sup>nd</sup> Edition, Appalachian Mountain Club Books, Boston, MA 1989.

### One Rope Bridge

- a. MCRP 3-35.2B Military Mountaineering
- b. TC 90-6-1, Military Mountaineering
- c. MCRP 3-35.2A, Small Unit Leader's Guide to Mountain Operations
- d. Bechdel, Les; Ray, Slim, River Rescue 2<sup>nd</sup> Edition, Appalachian Mountain Club Books, Boston, MA 1989.
- e. Padgett, Allen; Smith, Bruce, On Rope-4<sup>th</sup> Printing, National Speleological Society, 1992.

### A-Frames

- a. MCRP 3-35.2B Military Mountaineering
- b. TC 90-6-1, Military Mountaineering
- c. Mountain Operations Manual 2000, Northern Warfare Training Center, US Army
- d. MCRP 3-35.2A, Small Unit Leader's Guide to Mountain Operations

### Vertical Hauling Lines

- a. MCRP 3-35.2B Military Mountaineering
- b. TC 90-6-1, Military Mountaineering
- c. MCRP 3-35.2A, Small Unit Leader's Guide to Mountain Operations
- d. Manual of US Cave Rescue Techniques-2<sup>nd</sup> Edition, Speleological Society, 1988
- e. Padgett, Allen; Smith, Bruce, On Rope-4<sup>th</sup> Printing, National Speleological Society, 1992.

### Suspension Traverse

- a. MCRP 3-35.2B Military Mountaineering
- b. TC 90-6-1, Military Mountaineering
- c. MCRP 3-35.2A, Small Unit Leader's Guide to Mountain Operations
- d. Manual of US Cave Rescue Techniques-2<sup>nd</sup> Edition, Speleological Society, 1988
- e. Padgett, Allen; Smith, Bruce, On Rope-4<sup>th</sup> Printing, National Speleological Society, 1992.

### Rappelling

- a. MCRP 3-35.2B Military Mountaineering
- b. TC 90-6-1, Military Mountaineering
- c. Mountain Operations Manual 2000, Northern Warfare Training Center, US Army
- d. MCRP 3-35.2A, Small Unit Leader's Guide to Mountain Operations
- e. Mountaineering, The Freedom of the Hills, 6<sup>th</sup> Edition, The Mountaineers, Seattle WA 1996.
- f. Frank, James A.; Patterson, Donald E.; Rappel Manual, CMC Rescue, Inc. Santa Barbara, CA.

### Balance Climbing

- a. MCRP 3-35.2B Military Mountaineering
- b. TC 90-6-1, Military Mountaineering
- c. Mountain Operations Manual 2000, Northern Warfare Training Center, US Army
- d. Mountaineering, The Freedom of the Hills, 6<sup>th</sup> Edition, The Mountaineers, Seattle WA 1996.
- e. Long, John, Rock Climb 2<sup>nd</sup> Edition 1993, Chockstone Press Inc, Evergreen, CO.

### Top Roping

- a. MCRP 3-35.2B Military Mountaineering
- b. TC 90-6-1, Military Mountaineering
- c. Mountain Operations Manual 2000, Northern Warfare Training Center, US Army
- d. Mountaineering, The Freedom of the Hills, 6<sup>th</sup> Edition, The Mountaineers, Seattle WA 1996.
- e. Long, John, Climbing Anchors-1993, Chockstone Press Inc, Evergreen, CO

### SIT Harness

- a. MCRP 3-35.2B Military Mountaineering
- b. TC 90-6-1, Military Mountaineering
- c. Mountaineering, The Freedom of the Hills, 6<sup>th</sup> Edition, The Mountaineers, Seattle WA 1996.
- d. Long, John, Climbing Anchors-1993, Chockstone Press Inc, Evergreen, CO

### Placing Protection

- a. MCRP 3-35.2B Military Mountaineering
- b. TC 90-6-1, Military Mountaineering
- c. Mountain Operations Manual 2000, Northern Warfare Training Center, US Army
- d. Mountaineering, The Freedom of the Hills, 6<sup>th</sup> Edition, The Mountaineers, Seattle WA1996.
- e. Long, John, Climbing Anchors-1993, Chockstone Press Inc, Evergreen, CO
- f. Long, John, Rock Climb 2<sup>nd</sup> Edition 1993, Chockstone Press Inc, Evergreen, CO.
- g. Robbins, Roy, Basic Rock Craft-1971, La Siesta Press, Glendale, CA

#### Belaying for Party Climbing

- a. MCRP 3-35.2B Military Mountaineering
- b. TC 90-6-1, Military Mountaineering
- c. Mountain Operations Manual 2000, Northern Warfare Training Center, US Army
- d. Mountaineering, The Freedom of the Hills, 6<sup>th</sup> Edition, The Mountaineers, Seattle WA1996.
- e. Long, John, Climbing Anchors-1993, Chockstone Press Inc, Evergreen, CO
- f. Long, John, Rock Climb 2<sup>nd</sup> Edition 1993, Chockstone Press Inc, Evergreen, CO.
- g. Robbins, Roy, Basic Rock Craft-1971, La Siesta Press, Glendale, CA

#### Party Climbing

- a. MCRP 3-35.2B Military Mountaineering
- b. TC 90-6-1, Military Mountaineering
- c. Mountain Operations Manual 2000, Northern Warfare Training Center, US Army
- d. Mountaineering, The Freedom of the Hills, 6<sup>th</sup> Edition, The Mountaineers, Seattle WA1996.
- e. Long, John, Climbing Anchors-1993, Chockstone Press Inc, Evergreen, CO
- f. Long, John, Rock Climb 2<sup>nd</sup> Edition 1993, Chockstone Press Inc, Evergreen, CO.
- g. Robbins, Roy, Basic Rock Craft-1971, La Siesta Press, Glendale, CA

#### Military Aid Climbing

- a. MCRP 3-35.2B Military Mountaineering
- b. TC 90-6-1, Military Mountaineering
- c. Mountain Operations Manual 2000, Northern Warfare Training Center, US Army
- d. Mountaineering, The Freedom of the Hills, 6<sup>th</sup> Edition, The Mountaineers, Seattle WA1996.

#### Alternative Belays and Anchors

- a. MCRP 3-35.2B Military Mountaineering
- b. TC 90-6-1, Military Mountaineering
- c. Manual of Military Mountaineering 1992, Mountain and Arctic Warfare Cadre Royal

### Marines

- d. Mountain Operations Manual 2000, Northern Warfare Training Center, US Army
- e. Mountaineering, The Freedom of the Hills, 6<sup>th</sup> Edition, The Mountaineers, Seattle WA1996.
- f. Long, John, Climbing Anchors-1993, Chockstone Press Inc, Evergreen, CO
- g. Long, John, Rock Climb 2<sup>nd</sup> Edition 1993, Chockstone Press Inc, Evergreen, CO.
- h. Robbins, Roy, Basic Rock Craft-1971, La Siesta Press, Glendale, CA

### Rescue for Party Climbing

- a. MCRP 3-35.2B Military Mountaineering
- b. TC 90-6-1, Military Mountaineering
- c. Manual of Military Mountaineering 1992, Mountain and Arctic Warfare Cadre Royal Marines
- d. Mountaineering, The Freedom of the Hills, 6<sup>th</sup> Edition, The Mountaineers, Seattle WA1996.

### Steep Earth Climbing

- a. MCRP 3-35.2B Military Mountaineering
- b. TC 90-6-1, Military Mountaineering
- c. Manual of Military Mountaineering 1992, Mountain and Arctic Warfare Cadre Royal Marines
- d. Mountain Operations Manual 2000, Northern Warfare Training Center, US Army

### Tree Climbing Techniques

### Fixed Rope Installation

- a. MCRP 3-35.2B Military Mountaineering
- b. TC 90-6-1, Military Mountaineering
- c. Manual of Military Mountaineering 1992, Mountain and Arctic Warfare Cadre Royal Marines
- d. Mountain Operations Manual 2000, Northern Warfare Training Center, US Army

### Cliff Reconnaissance

- a. MCRP 3-35.2B Military Mountaineering
- b. TC 90-6-1, Military Mountaineering
- c. Mountain Operations Manual 2000, Northern Warfare Training Center, US Army

### Cliff Assault

- a. MCRP 3-35.2B Military Mountaineering
- b. TC 90-6-1, Military Mountaineering
- c. Mountain Operations Manual 2000, Northern Warfare Training Center, US Army



**MAC KIT COMPONENTS LIST**

SL-3-10161A				
ITEM NO.	STOCK NUMBER	ITEM IDENTIFICATION	UNIT OF MEAS	QUANTITY
1	8465-01-415-5135	ASCENDER	EA	8
2	8465-01-412-0148	BAG, CLIMBING GEAR	EA	20
3	8465-01-408-8193	BIGGER BREAKER	EA	8
4	8465-01-412-3106	CAMMING DEVICE: red; sm; spring loaded quadcam; 10.5-16.5mm	EA	4
5	8465-01-412-0151	CAMMING DEVICE: orn; sm; spring loaded quadcam; 13.0-19mm	EA	4
6	8465-01-412-0149	CAMMING DEVICE: yel; sm; spring loaded quadcam; 15.0-23mm	EA	4
7	8465-01-412-0150	CAMMING DEVICE: grn; sm; spring loaded quadcam; 20.0-30mm	EA	4
8	8465-01-412-0152	CAMMING DEVICE: blu; sm; spring loaded quadcam; 24.0-36mm	EA	4
9	8465-01-412-0144	CAMMING DEVICE: red; lrg; spring loaded quadcam; No. 1	EA	4
10	8465-01-412-0146	CAMMING DEVICE: gld; lrg; spring loaded quadcam; No. 2	EA	4
11	8465-01-412-0147	CAMMING DEVICE: blu; lrg; spring loaded quadcam; No. 3	EA	4
12	8465-01-412-0574	CAMMING DEVICE: blk; lrg; spring loaded quadcam; No. 4	EA	4
13	8465-01-415-5134	CARABINERS, LOCKING, MODIFIED	EA	240
14	8465-01-415-5137	CARABINERS, OMEGA	EA	336
15	5130-01-414-5896	CUTTER, ROPE, ELECTRICAL	EA	1
16	8465-01-415-5136	HARNESS, VARIO SIT	EA	8
17	8465-01-415-7020	HEXENTRICS; nut no. 1w	EA	4
18	8465-01-415-7446	HEXENTRICS; nut no. 2w	EA	4
19	8465-01-415-7447	HEXENTRICS; nut no. 3w	EA	4
20	8465-01-415-7448	HEXENTRICS; nut no. 10	EA	4
21	8465-01-415-7449	HEXENTRICS; nut no. 7	EA	4
22	8465-01-415-7445	HEXENTRICS; nut no. 5	EA	4
23	8465-01-415-7444	HEXENTRICS; nut no. 6	EA	4
24	8465-01-415-7443	HEXENTRICS; nut no. 4	EA	4
25	8465-01-415-7452	HEXENTRICS; nut no. 8	EA	4
26	8465-01-415-7453	HEXENTRICS; nut no. 9	EA	4
27	4240-01-409-2006	LADDER, ESCAPE	EA	10
28	8465-01-414-1807	NUT, STOPPER; No 2	EA	4
29	8465-01-414-1808	NUT, STOPPER; No 1	EA	4
30	8465-01-414-1809	NUT, STOPPER; No 4	EA	4
31	8465-01-414-1810	NUT, STOPPER; No 3	EA	4
32	8465-01-414-2747	NUT, STOPPER; No 10	EA	4

33	8465-01-414-2748	NUT, STOPPER; No 6	EA	4
34	8465-01-414-2749	NUT, STOPPER; No 5	EA	4
35	8465-01-414-2750	NUT, STOPPER; No 9	EA	4
36	8465-01-414-2751	NUT, STOPPER; No 7	EA	4
37	8465-01-414-2752	NUT, STOPPER; No 8	EA	4
38	8465-01-414-2753	NUT, STOPPER; No 11	EA	4
39	8465-01-414-2755	NUT, STOPPER; No 12	EA	4
40	5120-01-410-7213	NUT TOOL, CLIMBER'S	EA	8
41	3020-01-411-1132	PULLEY ASSEMBLY, CLIMBER'S EQUIP	EA	8
42	8465-01-412-0145	RACK PACK	EA	8
43	4020-01-411-9059	ROPE, FIBROUS (Dynamic), 165 ft	EA	32
44	4020-01-400-2853	ROPE, FIBROUS (Static), 600 ft	EA	5
45	4020-01-400-5862	ROPE, FIBROUS, 5.5mm spectrum, 150 ft	EA	1
46	4020-01-400-5864	ROPE, FIBROUS, 7mm, 300 ft	EA	1
47	4020-01-411-9053	ROPE, FIBROUS, (Static), 300 ft	EA	8
48	8145-01-406-1427	SHIPPING AND STORAGE CONTAINER	EA	4
49	8305-01-409-0889	WEBBING, TEXTILE (Tubular), 300 ft	EA	2

## APPENDIX I